



## MP3/WMA/AAC CD Receiver

# CDA-105

**MP3**



**AAC**



- **OWNER'S MANUAL**  
Please read before using this equipment.
- **MODE D'EMPLOI**  
Veuillez lire avant d'utiliser cet appareil.
- **MANUAL DE OPERACIÓN**  
Léalo antes de utilizar este equipo.

**ALPINE ELECTRONICS MARKETING, INC.**  
1-1-8 Nishi Gotanda,  
Shinagawa-ku,  
Tokyo 141-0031, Japan  
Phone 03-5496-8231

**ALPINE ELECTRONICS OF AMERICA, INC.**  
19145 Gramercy Place, Torrance,  
California 90501, U.S.A.  
Phone 1-800-ALPINE-1 (1-800-257-4631)

**ALPINE ELECTRONICS OF CANADA, INC.**  
777 Superstest Road, Toronto,  
Ontario M3J 2M9, Canada  
Phone 1-800-ALPINE-1 (1-800-257-4631)

**ALPINE ELECTRONICS OF AUSTRALIA PTY. LTD.**  
161-165 Princes Highway, Hallam  
Victoria 3803, Australia  
Phone 03-8787-1200

**ALPINE ELECTRONICS GmbH**  
Frankfurter Ring 117, 80807 München, Germany  
Phone 089-32 42 640

**ALPINE ELECTRONICS OF U.K. LTD.**  
Alpine House  
Fletchamstead Highway, Coventry CV4 9TW, U.K.  
Phone 0870-33 33 763

**ALPINE ELECTRONICS FRANCE S.A.R.L.**  
(RCS PONTOISE B 338 101 280)  
98, Rue de la Belle Etoile, Z.I. Paris Nord II,  
B.P. 50016, 95945 Roissy Charles de Gaulle  
Cedex, France  
Phone 01-48638989

**ALPINE ITALIA S.p.A.**  
Viale C. Colombo 8, 20090 Trezzano  
Sul Naviglio (MI), Italy  
Phone 02-484781

**ALPINE ELECTRONICS DE ESPAÑA, S.A.**  
Portal de Gamarra 36, Pabellón, 32  
01013 Vitoria (Alava)-APDO 133, Spain  
Phone 945-283588

**ALPINE ELECTRONICS (BENELUX) GmbH**  
Leuvensesteenweg 510-B6,  
1930 Zaventem, Belgium  
Phone 02-725-13 15

EN

FR

ES



**iPod**  
5th generation  
(video)  
30GB



**iPod**  
5th generation  
(video)  
60GB 80GB



**iPod nano**  
1st generation  
1GB 2GB 4GB



**iPod nano**  
2nd generation  
(aluminum)  
2GB 4GB 8GB



**iPod nano**  
3rd generation  
(video)  
4GB 8GB



**iPod classic**  
80GB 160GB



**iPod touch**  
1st generation  
8GB 16GB 32GB



**iPhone**  
4GB 8GB 16GB



**iPhone 3G**  
8GB 16GB

# Contents

## Operating Instructions

### WARNING

<b>WARNING</b> .....	<b>3</b>
<b>CAUTION</b> .....	<b>3</b>
<b>PRECAUTIONS</b> .....	<b>3</b>

### Getting Started

Accessory List .....	6
Turning Power On and Off .....	6
Detaching and Attaching the Front Panel .....	6
Initial System Start-Up .....	6
Adjusting Volume .....	7
Lowering Volume Quickly .....	7
Setting the Time .....	7

### Radio

Listening to Radio .....	7
Presetting Stations Manually .....	8
Presetting Stations Automatically .....	8
Tuning to Preset Stations .....	8
Frequency Search Function .....	8
Receiving a Multicast Station (HD Radio™ Reception) (HD Radio mode only) .....	8

### CD/MP3/WMA/AAC

Playback .....	9
Repeat Play .....	9
M.I.X. (Random Play) .....	10
Searching for CD Text .....	10
File/Folder Name Search (Concerning MP3/WMA/AAC) .....	10
Quick Search .....	11
About MP3/WMA/AAC .....	11

### Sound Setting

Adjusting Subwoofer Level/Bass Level/Treble Level/Balance (Between Left and Right)/Fader (Between Front and Rear)/Defeat .....	12
Setting the Subwoofer Level .....	13

Setting the Bass Control .....	13
Setting the Bass Center Frequency .....	13
Setting the Bass Bandwidth .....	13
Setting the Bass Level .....	13
Setting the Treble Control .....	13
Setting the Treble Center Frequency .....	13
Setting the Treble Level .....	13
Adjusting the High Pass Filter .....	14
Turning Loudness On/Off .....	14
Turning Subwoofer ON/OFF .....	14
Setting the Subwoofer System .....	14

### Other Functions

Displaying the Text .....	15
Displaying Time .....	16

### SETUP

#### BLUETOOTH IN

Setting the Bluetooth Connection .....	17
--	----

#### Visual Customizing

Changing Lighting Color .....	17
Adjusting Display Contrast .....	17
Dimmer Control .....	17
Scroll Type Setting .....	17
Scroll Setting (TEXT SCROLL) .....	17
Setting the Language Font .....	17
Demonstration .....	17

#### MP3/WMA/AAC

Playing MP3/WMA/AAC Data (PLAY MODE) .....	17
---	----

#### External Device

Connecting to an External Amplifier .....	17
Turning Mute Mode On/Off (INT MUTE) .....	18
Setting the AUX+ SETUP Mode .....	18
Setting the AUX+ Level (AUX IN GAIN) .....	18
Setting the External Digital Input .....	18
Setting the AUX Mode (V-Link) .....	18
Changer Name Setting .....	18

#### HD Radio Reception (only when HD Radio Tuner module is connected)

HD Radio Station Call Setting (STATION CALL) .....	18
Digital Seek ON/OFF Setting .....	18

### SAT Radio Receiver (Optional)

Receiving Channels with the SAT Radio Receiver (Optional) .....	19
Checking the SAT Radio ID Number .....	19

Storing Channel Presets .....	19
Receiving Stored Channels .....	20
Storing the desired Sports Team (SIRIUS only) .....	20
Storing while receiving a game broadcast ...	20
Game Alert Setup .....	20
Storing the desired Song/Artist (SIRIUS only) .....	20
Recalling the stored information (SIRIUS only) .....	21
If more than 2 Alerts are found (Blinking ALERT indicator) .....	21
Canceling the stored Alert Memory (SIRIUS only) .....	21
Search Function .....	21
Category Search mode .....	21
Channel/Artist/Song Search mode .....	21
Quick Search Function .....	21
Receiving Weather or Traffic Information from SAT Radio .....	21
Instant Replay Function (SIRIUS only) .....	22
Changing the Display .....	22
Setting the Auxiliary Data Field Display (XM only) .....	22

## USB memory (Optional)

Controlling USB memory (Optional) .....	23
Playing MP3/WMA/AAC Files with the USB memory (Optional) .....	23

## iPhone/iPod (Optional)

Playback .....	24
Searching for a desired Song .....	24
Quick Search .....	25
Direct Search Function .....	25
Select Playlist/Artist/Album/Genre/ Composer .....	25
Alphabet Skip Function .....	25
Random Play Shuffle (M.I.X.) .....	26
Repeat Play .....	26
Displaying the Text .....	26

## IMPRINT Operation (Optional)

Changing MultEQ mode .....	27
Adjusting Subwoofer Level/Bass Level/Treble Level/Fader (Between Front and Rear)/ Balance (Between Left and Right) in MultEQ mode .....	27

Adjusting Sound Setting in Manual Mode .....	28
Turning Subwoofer ON/OFF .....	28
Setting the Subwoofer System .....	28
Setting the Subwoofer Phase .....	28
Setting the Subwoofer Channel (SUBW CHANNEL) .....	28
Equalizer Presets (FACTORY'S EQ) .....	28
Setting the Response Slope for the High Range Speaker (TW SETUP) .....	28
Setting the Filter type .....	29
Turning Media Xpander ON/OFF .....	29
Setting the MX Level .....	29
Setting EQ mode .....	29
Setting the Time Correction Unit (T.CORR PARA) .....	29
Sound Field Adjustment (SOUND ADJUST) .....	29
Adjusting the Parametric Equalizer Curve .....	29
Adjusting the Graphic Equalizer Curve .....	30
Adjusting the Time Correction .....	30
Adjusting the Crossover Settings .....	30
Storing the Sound Field Adjustment Settings .....	31
Recalling the Stored Sound Field Adjustment Settings .....	31
About Time Correction .....	32
About the Crossover .....	33
About IMPRINT .....	34

## Changer (Optional)

Controlling CD Changer (Optional) .....	35
Playing MP3 Files with the CD Changer (Optional) .....	35
Multi-Changer Selection (Optional) .....	35

## Information

In Case of Difficulty .....	36
Specifications .....	39

## Installation and Connections

<b>Warning</b> .....	<b>40</b>
<b>Caution</b> .....	<b>40</b>
<b>Precautions</b> .....	<b>40</b>
Installation .....	41
Connections .....	43

## LIMITED WARRANTY

---

---

# Operating Instructions

## WARNING



This symbol means important instructions. Failure to heed them can result in serious injury or death.

---

### DO NOT OPERATE ANY FUNCTION THAT TAKES YOUR ATTENTION AWAY FROM SAFELY DRIVING YOUR VEHICLE.

Any function that requires your prolonged attention should only be performed after coming to a complete stop. Always stop the vehicle in a safe location before performing these functions. Failure to do so may result in an accident.

---

### KEEP THE VOLUME AT A LEVEL WHERE YOU CAN STILL HEAR OUTSIDE NOISES WHILE DRIVING.

Excessive volume levels that obscure sounds such as emergency vehicle sirens or road warning signals (train crossings, etc.) can be dangerous and may result in an accident. LISTENING AT LOUD VOLUME LEVELS IN A CAR MAY ALSO CAUSE HEARING DAMAGE.

---

### MINIMIZE DISPLAY VIEWING WHILE DRIVING.

Viewing the display may distract the driver from looking ahead of the vehicle and cause an accident.

---

### DO NOT DISASSEMBLE OR ALTER.

Doing so may result in an accident, fire or electric shock.

---

### USE ONLY IN CARS WITH A 12 VOLT NEGATIVE GROUND.

(Check with your dealer if you are not sure.) Failure to do so may result in fire, etc.

---

### KEEP SMALL OBJECTS SUCH AS BATTERIES OUT OF THE REACH OF CHILDREN.

Swallowing them may result in serious injury. If swallowed, consult a physician immediately.

---

### USE THE CORRECT AMPERE RATING WHEN REPLACING FUSES.

Failure to do so may result in fire or electric shock.

---

### DO NOT BLOCK VENTS OR RADIATOR PANELS.

Doing so may cause heat to build up inside and may result in fire.

---

### USE THIS PRODUCT FOR MOBILE 12V APPLICATIONS.

Use for other than its designed application may result in fire, electric shock or other injury.

---

### DO NOT PLACE HANDS, FINGERS OR FOREIGN OBJECTS IN INSERTION SLOTS OR GAPS.

Doing so may result in personal injury or damage to the product.



This symbol means important instructions. Failure to heed them can result in injury or material property damage.

---

### HALT USE IMMEDIATELY IF A PROBLEM APPEARS.

Failure to do so may cause personal injury or damage to the product. Return it to your authorized Alpine dealer or the nearest Alpine Service Center for repairing.

---

## PRECAUTIONS

---

### Product Cleaning

Use a soft dry cloth for periodic cleaning of the product. For more severe stains, please dampen the cloth with water only. Anything else has the chance of dissolving the paint or damaging the plastic.

---

### Temperature

Be sure the temperature inside the vehicle is between +60°C (+140°F) and -10°C (+14°F) before turning your unit on.

---

### Moisture Condensation

You may notice the CD playback sound wavering due to condensation. If this happens, remove the disc from the player and wait about an hour for the moisture to evaporate.

---

### Damaged Disc

Do not attempt to play cracked, warped, or damaged discs. Playing a bad disc could severely damage the playback mechanism.

---

### Maintenance

If you have problems, do not attempt to repair the unit yourself. Return it to your Alpine dealer or the nearest Alpine Service Station for servicing.

---

## Never Attempt the Following

Do not grip or pull out the disc while it is being pulled back into the player by the automatic reloading mechanism.

Do not attempt to insert a disc into the unit when the unit power is off.

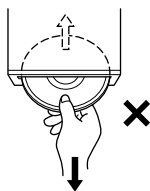

---

## Inserting Discs

Your player accepts only one disc at a time for playback. Do not attempt to load more than one disc.

Make sure the label side is facing up when you insert the disc. "ERROR" will be displayed on your player if you insert a disc incorrectly. If "ERROR" continues to be displayed even though the disc has been inserted correctly, push the RESET switch with a pointed object such as a ballpoint pen.

Playing a disc while driving on a very bumpy road may result in skips, but this will not scratch the disc or damage the player.

---

## New Discs

To prevent the CD from jamming, "ERROR" is displayed if discs with irregular surfaces are inserted or if discs are inserted incorrectly. When a new disc is ejected immediately after initial loading, use your finger to feel around the inside of the center hole and outside edge of the disc. If you feel any small bumps or irregularities, this could inhibit proper loading of the disc. To remove the bumps, rub the inside edge of the hole and outside edge of the disc with a ballpoint pen or other such instrument, then insert the disc again.

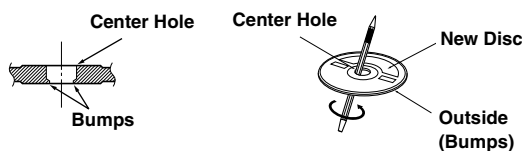

---

## Irregular Shaped Discs

Be sure to use round shape discs only for this unit and never use any special shape discs.

Use of special shape discs may cause damage to the mechanism.



---

## Installation Location

Make sure this unit will not be installed in a location subjected to:

- Direct sun and heat
- High humidity and water
- Excessive dust
- Excessive vibrations

---

## Correct Handling

Do not drop the disc while handling. Hold the disc so you will not leave fingerprints on the surface. Do not affix tape, paper, or gummed labels to the disc. Do not write on the disc.

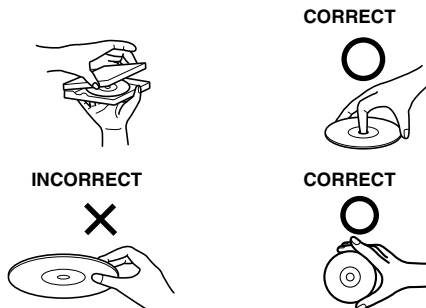

---

## Disc Cleaning

Fingerprints, dust, or soil on the surface of the disc could cause the CD player to skip. For routine cleaning, wipe the playing surface with a clean, soft cloth from the center of the disc to the outer edge. If the surface is heavily soiled, dampen a clean, soft cloth in a solution of mild neutral detergent before cleaning the disc.



---

## Disc Accessories

There are various accessories available on the market for protecting the disc surface and improving sound quality. However, most of them will influence the thickness and/or diameter of the disc. Using such accessories can cause the disc to be out of standard specifications and may create operational problems. We recommend not using these accessories on discs played in Alpine CD players.



Transparent Sheet

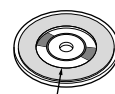

Disc Stabilizer

---

## On handling Compact Discs (CD/CD-R/CD-RW)

- Do not touch the surface.
- Do not expose the disc to direct sunlight.
- Do not affix stickers or labels.
- Clean the disc when it is dusty.
- Make sure that there are no bumps around the disc.
- Do not use commercially available disc accessories.

**Do not leave the disc in the car or the unit for a long time. Never expose the disc to direct sunlight.** Heat and humidity may damage the CD and you may not be able to play it again.

---

## To customers using CD-R/CD-RW

- If a CD-R/CD-RW cannot be played back, make sure the last recording session was closed (finalized).
- Finalize the CD-R/CD-RW if necessary, and attempt playback again.

---

## About media that can be played

Use only compact discs with the label side showing the CD logo marks below.



If you use unspecified compact discs, correct performance cannot be guaranteed.

You can play CD-Rs (CD-Recordables)/CD-RWs (CD-ReWritables) which have been recorded only on audio devices. You can also play CD-Rs/CD-RWs containing MP3/WMA/AAC formatted audio files.

- Some of the following CDs may not play on this unit:  
Flawed CDs, CDs with fingerprints, CDs exposed to extreme temperatures or sunlight (e.g., left in the car or this unit), CDs recorded under unstable conditions, CDs on which a recording failed or a re-recording was attempted, copy-protected CDs which do not conform to the audio CD industry standard.
- Use discs with MP3/WMA/AAC files written in a format compatible with this unit. For details, see pages 11-12.
- ROM data other than audio files contained in a disc will not produce sound when played back.

---

## Protecting the USB connector

- Only a USB memory iPhone/iPod can be connected to the USB connector on this unit. Correct performance using other USB products cannot be guaranteed.
- If the USB connector is used, be sure to connect it to the unit by using a USB extension cable (sold separately). A USB hub is not supported.
- Depending on the connected USB memory device, the unit may not function or some functions may not be performed.
- The audio file format that can be played back on the unit is MP3/WMA/AAC.
- Artist/song name, etc., can be displayed, however characters may not be correctly displayed.



*Alpine accepts no responsibility for lost data, etc., even if data, etc., is lost while using this product.*

---

## On Handling USB Memory

- To prevent malfunction or damage, note the following points.  
Read the USB memory Owner's Manual thoroughly.  
Do not touch the terminals by hand or metal.  
Do not subject USB memory to excessive shock.  
Do not bend, drop, disassemble, modify or soak in the water.
- Avoid usage or storage in the following locations:  
Anywhere in the car exposed to direct sunlight or high temperatures.  
Anywhere the possibility of high humidity or corrosive substances are present.
- Fix the USB memory in a location where driver operation will not be hindered.
- USB memory may not function correctly at high or low temperature.
- Use only certified USB memory. Note that even certified USB memory, may not function correctly depending on its type or state.

- USB memory function is not guaranteed. Use USB memory according to the terms of agreement.
- Depending on the settings of the USB memory type, memory state or encoding software, the unit may not play back or display properly.
- A file that is copy-protected (copyright protection) cannot be played back.
- USB memory may take time to start playback. If there is a particular file other than audio in the USB memory, it may take considerable time before the file is played back or searched.
- The unit can play back "mp3", "wma" or "m4a" file extensions.
- Do not add the above extensions to a file other than audio data. This non-audio data will not be recognized. The resulting playback may contain noise that can damage speakers and/or amplifiers.
- It is recommended to back up important data on a personal computer.
- Do not remove the USB device while playback is in progress. Change SOURCE to something other than USB, then remove the USB device to prevent possible damage to its memory.

- 
- *Windows Media and the Windows logo are trademarks, or registered trademarks of Microsoft Corporation in the United States and/or other countries.*
  - *iPod and iTunes are trademarks of Apple Inc., registered in the U.S. and other countries.*
  - *iPhone is a trademark of Apple Inc.*
  - *"Made for iPod" means that an electronic accessory has been designed to connect specifically to iPod and has been certified by the developer to meet Apple performance standards.*
  - *"Works with iPhone" means that an electronic accessory has been designed to connect specifically to iPhone and has been certified by the developer to meet Apple performance standards.*
  - *Apple is not responsible for the operation of this device or its compliance with safety and regulatory standards.*
  - *The Bluetooth word mark and logos are owned by the Bluetooth SIG, Inc. and any use of such marks by Alpine Electronics, Inc. is under license. Other trademarks and trade names are those of their respective owners.*
  - *HD Radio™ and the HD and HD Radio Ready logos are proprietary trademarks of iBiquity Digital Corp.*
  - *"MPEG Layer-3 audio coding technology licensed from Fraunhofer IIS and Thomson."*
  - *"Supply of this product only conveys a license for private, non-commercial use and does not convey a license nor imply any right to use this product in any commercial (i.e. revenue-generation) real time broadcasting (terrestrial, satellite, cable and/or any other media), broadcasting/streaming via internet, intranets and/or other networks or in other electronic content distribution systems, such as pay-audio or audio-on-demand applications. An independent license for such use is required. For details, please visit <http://www.mp3licensing.com>"*
  - *Audyssey MultEQ XT is a registered trademark of Audyssey laboratories Inc.*

# Getting Started

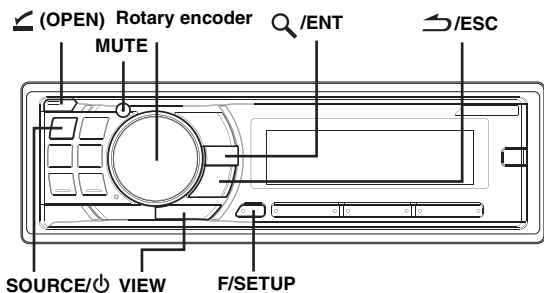

## Accessory List

- Head unit .....1
- Power cable .....1
- Mounting sleeve.....1
- Carrying case.....1
- Bracket key.....2
- Screw (M5 × 8).....4
- Owner's Manual ..... 1 set

## Turning Power On and Off

Press **SOURCE/⏻** to turn on the unit.

- The unit can be turned on by pressing any other button except **VIEW**.

Press and hold **SOURCE/⏻** for at least 2 seconds to turn off the unit.

- The first time power is turned on, the volume will start from level 12.

## Detaching and Attaching the Front Panel

### Detaching

- 1 Turn off the unit power.
- 2 Press **(OPEN)** to open the front panel.

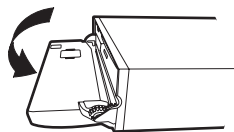

To close the front panel, press the left side until it locks as shown in the figure below.

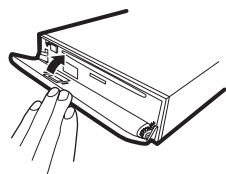

- 3 Grasp the front panel firmly, slide to the left **1**, and then pull **2** to remove.

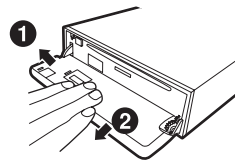

- The front panel may become hot in normal usage (especially the connector terminals on the back of the front panel). This is not a malfunction.
- To protect the front panel, place it in the supplied carrying case.
- When detaching the front panel, do not apply excessive force as it may result in malfunction.
- Do not leave the front panel open, or drive the car with the panel open as it may result in an accident or malfunction.

### Attaching

- 1 Insert the right side of the front panel into the main unit. Align the groove on the front panel with the projections on the main unit.
- 2 Push the left side of the front panel until it locks firmly into the main unit.

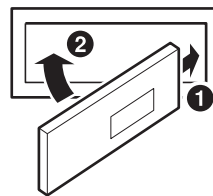

- Before attaching the front panel, make sure that there is no dirt or dust on the connector terminals and no foreign object between the front panel and the main unit.
- Attach the front panel carefully, holding the sides of the front panel to avoid pushing buttons by mistake.

## Initial System Start-Up

Be sure to press the RESET switch when using the unit for the first time, after changing the car battery, etc.

- 1 Turn off the unit power.
- 2 Press **(OPEN)** to open the front panel, and then remove it.
- 3 Press **RESET** with a ballpoint pen or similar pointed object.

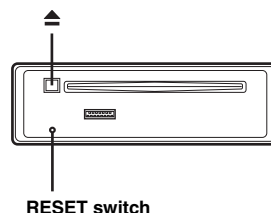



## Adjusting Volume

Turn the **Rotary encoder** until the desired sound is obtained.

## Lowering Volume Quickly

Activating the Audio Mute function will instantly lower the volume level by 20 dB.

Press **MUTE** to activate the **MUTE mode**.

The audio level will decrease by about 20 dB.

Pressing **MUTE** again will bring the audio back to its previous level.

## Setting the Time

- 1 Press and hold **F/SETUP** for at least 2 seconds to activate the **SETUP selection mode**.
- 2 Turn the **Rotary encoder** to select **CLOCK ADJUST**, and then press **Q/ENT**.
- 3 Turn the **Rotary encoder** to set hour.
- 4 Press **Q/ENT**.
- 5 Repeat steps 3 and 4 above to set minute.
- 6 Press and hold **F/SETUP** for at least 2 seconds to return to normal mode.

- Pressing **↶/ESC** returns to the previous **SETUP mode**.
- If no operation is performed for 60 seconds, **SETUP** is canceled.
- To synchronize the clock to another clock/watch or radio time announcement, press and hold **Q/ENT** for at least 2 seconds after setting the "hour." Minutes will reset to 00. If the display shows over "30" minutes when you do this, the time will advance one hour.

### Controllable with Remote Control

This unit can be controlled with an optional Alpine remote control. For details, consult your Alpine dealer. Point the optional remote control transmitter at the remote control sensor.

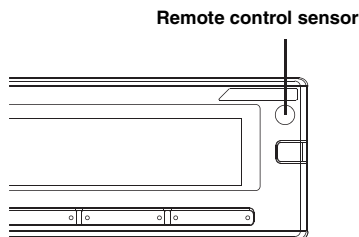

### Connectable to Remote Control Interface Box

This unit may be controlled from the vehicle's audio controls. An optional Alpine Remote Control Interface Box must be used. For details, contact your Alpine dealer.

# Radio

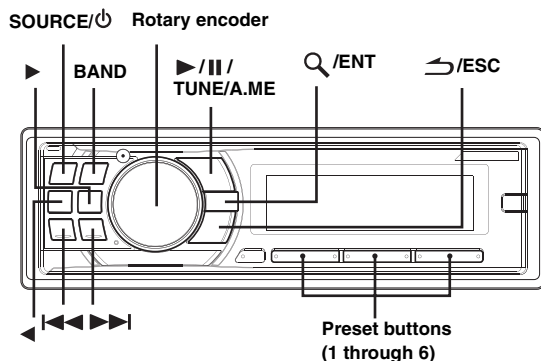

This unit cannot receive HD Radio signals (digital terrestrial radio). In order to activate the digital radio functions described below, an optional HD Radio Tuner module must be connected through the Ai-NET bus.

If the unit is connected to a Tagging compatible device, you can use the iTunes Tagging function. For details, refer to the Owner's Manual of the Tagging compatible device.

## Listening to Radio

- 1 Press **SOURCE/⏻** to select **TUNER mode**.
- 2 Press **BAND** repeatedly until the desired radio band is displayed.  
F1 (FM1) → F2 (FM2) → AM → F1 (FM1)
- 3 Press **TUNE/A.M.E** to select the tuning mode.  
DX SEEK (Distance mode) → SEEK (Local mode) → OFF (Manual mode) → DX SEEK (Distance mode)

- The initial mode is Distance mode.

### Distance mode:

Both strong and weak stations will be automatically tuned in (Automatic Seek Tuning).

### Local mode:

Only strong stations will be automatically tuned in (Automatic Seek Tuning).

### Manual mode:

The frequency is manually tuned in steps (Manual tuning).

- 4 Press **⏮** or **⏭** to tune in the desired station. Holding down **⏮** or **⏭** will change the frequency continuously.
- If **DIGITAL SEEK** is set to **ON**, the **SEEK UP/DOWN** functions only stop on digital station frequencies while receiving an **HD Radio** broadcast. Refer to "Digital Seek ON/OFF Setting" (page 18).

## Presetting Stations Manually

- 1 **Select the radio band and tune in a desired radio station you wish to store in the preset memory.**
  - 2 **Press and hold, for at least 2 seconds, any one of the preset buttons (1 through 6) into which you wish to store the station.**  
The selected station is stored.  
The display shows the band, preset number and station frequency memorized.
- A total of 18 stations can be stored in the preset memory (6 stations for each band; FM1, FM2 and AM).
  - If you store a station in a preset memory which already has a station, the current station will be cleared and replaced with the new station.

## Presetting Stations Automatically

- 1 **Press BAND repeatedly until the desired radio band is displayed.**
  - 2 **Press and hold TUNE/A.ME for at least 2 seconds.**  
The frequency on the display continues to change while the automatic memory is in progress. The tuner will automatically seek and store 6 strong stations in the selected band. They will be stored into preset buttons 1 to 6 in order of signal strength.  
When the automatic memory has been completed, the tuner goes to the station stored in preset location No. 1.
- If no stations are stored, the tuner will return to the original station you were listening to before the auto memory procedure began.

## Tuning to Preset Stations

- 1 **Press BAND repeatedly until the desired band is displayed.**
- 2 **Press any one of the station preset buttons (1 through 6) that has your desired radio station in memory.**  
The display shows the band, preset number and frequency of the station selected.

## Frequency Search Function

You can search for a radio station by its frequency.

- 1 **Press and hold Q/ENT for at least 2 seconds in Radio mode to activate Frequency search mode.**
  - 2 **Turn the Rotary encoder to select the desired frequency.**
  - 3\* **Press Q/ENT to receive the selected frequency.**
- \* Operation is not required during HD Radio reception.
- Press ↵/ESC in the search mode to cancel. Or, the search mode will be canceled if no operation is performed for 10 seconds.

## Receiving a Multicast Station (HD Radio™ Reception) (HD Radio mode only)

Multicasting is the Ability to broadcast multiple program streams over a single FM frequency. This increases the amount and diversity of content choices. A maximum of eight multicast station channels can be selected on this unit.

**When multicast station is received, the program number and the SPS indicator lights up. Press ◀ or ▶ to select the desired program service.**

Receiving the Multicast Station Program Service.

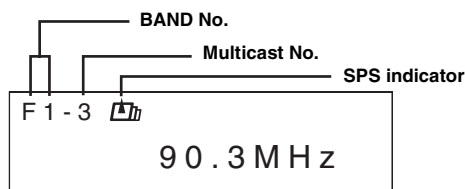

Program Service example:

Multicast Radio Station	Program No.	Program Service
90.3 MHz	No. 1	MPS: Main Program Service
90.3 MHz	No. 2	SPS: Sub-program Service
90.3 MHz	No. 3	SPS: Sub-program Service
90.3 MHz	No. 8	SPS: Sub-program Service

# CD/MP3/WMA/AAC

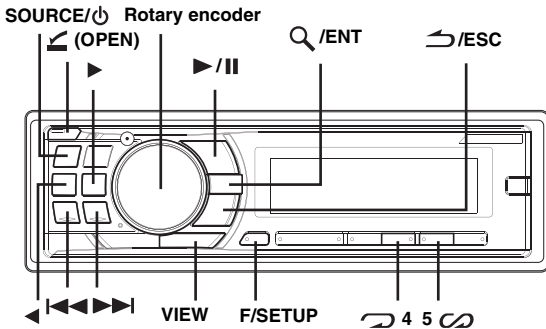

## Playback

### 1 Press (OPEN).

The front panel will open.

### 2 Insert a disc with the label side facing up.

The disc will be pulled into the unit automatically.

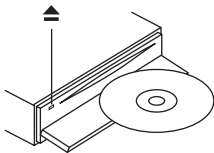

Close the front panel manually and the "CD" indicator lights up.

When a disc is already inserted, press SOURCE/⏻ to switch to the DISC mode.

TUNER → XM RADIO/SIRIUS\*<sup>1</sup> → DISC → USB AUDIO\*<sup>2</sup>/  
USB iPod\*<sup>3</sup> → BT AUDIO\*<sup>4</sup>/AUX+\*<sup>5</sup> → CHANGER\*<sup>6</sup> →  
TUNER

\*<sup>1</sup> Only when XM Radio or SIRIUS Radio is connected.

\*<sup>2</sup> Displayed only when no iPhone/iPod is connected.

\*<sup>3</sup> Displayed only when the iPhone/iPod is connected.

\*<sup>4</sup> Displayed only when BLUETOOTH IN is set to ADAPTE, refer to "Setting the Bluetooth Connection" (page 17).

\*<sup>5</sup> Displayed only when the AUX+ SETUP is set to ON, refer to "Setting the AUX+ SETUP Mode" (page 18).

\*<sup>6</sup> Only when the CD changer is connected.

### 3 While playing back MP3/WMA/AAC, press ◀ or ▶ to select the desired folder.

Pressing and holding ◀ or ▶ will change folders continuously.

### 4 Press ◀◀ or ▶▶ to select the desired track (file).

**Returning to the beginning of the current track (file):**

Press ◀◀.

**Fast backward:**

Press and hold ◀◀.

**Advancing to the beginning of the next track (file):**

Press ▶▶.

**Fast forward:**

Press and hold ▶▶.

### 5 To pause playback, press ▶||.

Pressing ▶|| again will resume playback.

### 6 After pressing (OPEN) to open the front panel, press ▲ to eject the disc.

- Do not remove a CD during its eject cycle. Do not load more than one disc at a time. A malfunction may result from doing either.
- If the CD does not eject, press and hold ▲ for at least 2 seconds.
- The "CD" indicator lights up when a disc is inserted.
- Three-inch (8 cm) CDs cannot be used.
- The CD-player can play discs containing audio data, MP3 data, WMA data and AAC data.
- "MP3" is displayed during MP3 playback.
- "WMA" is displayed during WMA playback.
- "AAC" is displayed during AAC playback.
- WMA format files that are protected by DRM (Digital Rights Management), AAC format files that have been purchased from iTunes Store and files that are copy-protected (copyright protection) cannot be played back on this unit.
- The track display for MP3/WMA/AAC data playback is the file numbers recorded on the disc.
- The playback time may not be correctly displayed when a VBR (Variable Bit Rate) recorded file is played back.

### MP3/WMA/AAC Play Display

The folder number and file number will be displayed as described below.

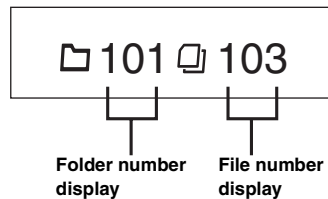

- Press VIEW to switch the display. See "Displaying the Text" (page 15) for information about display switching.

## Repeat Play

Press 4 to play back repeatedly the track being played.

The track (file) will be played repeatedly.

Press 4 again and select off to deactivate repeat play.

CD mode :

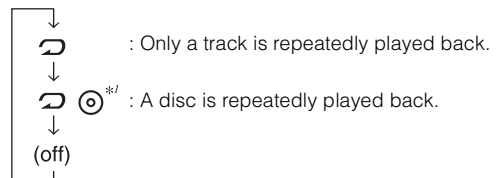

\*<sup>1</sup> When a CD changer is connected.

- If 4 is set to ON during M.I.X. play in CD changer mode, M.I.X. will apply to the current disc only.

MP3/WMA/AAC mode :

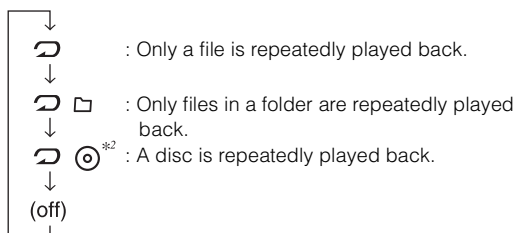

<sup>\*2</sup> When an MP3 compatible CD changer is connected.

- If a CD changer or an MP3 compatible CD changer is connected: After pressing **F/SETUP** to select the function mode (/), perform the operation within 10 seconds.

## M.I.X. (Random Play)

Press **5** in the play or pause mode.

The tracks (files) on the disc will be played back in random sequence.

To cancel M.I.X. play, press **5** again.

Internal CD mode :

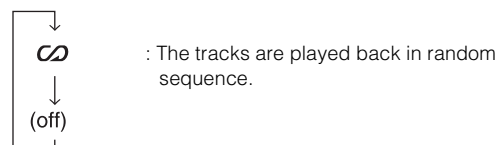

CD Changer mode :

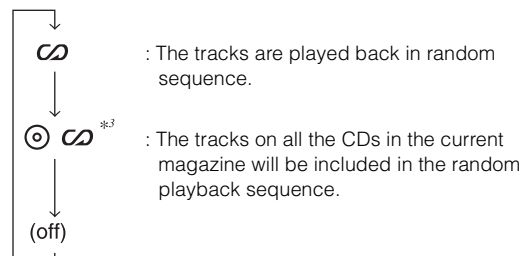

<sup>\*3</sup> When a CD changer equipped with the ALL M.I.X. function is connected.

- If M.I.X. is set to ON during (REPEAT ALL) play in CD changer mode, M.I.X. will apply to the current disc only.

MP3/WMA/AAC mode :

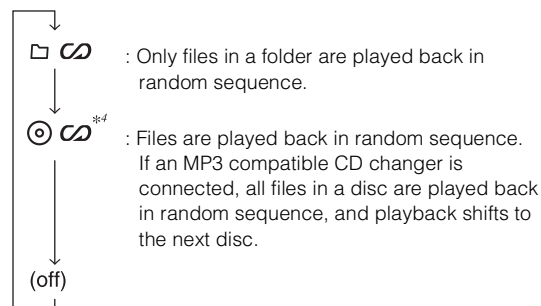

<sup>\*4</sup> In the USB mode, all files stored in the USB memory are played back in random sequence, and the "" indicator lights up.

- When a song is played back during Random (M.I.X.) play in the USB mode, the song can be played back again randomly even if not all songs on the USB Memory have been played back.

- If a CD changer or an MP3 compatible CD changer is connected: After pressing **F/SETUP** to select the function mode (/), perform the operation within 10 seconds.

## Searching for CD Text

On discs utilizing CD Text, songs can be searched and played by using their recorded titles. For discs without CD Text, searches are made using the track numbers associated with each song.

- 1 Press /ENT during play.**  
This will set the search mode.
- 2 Turn the Rotary encoder to select the desired track, and then press /ENT.**  
This will play the selected track.

- Press /ESC in the search mode to cancel. Or, the search mode is canceled if no operation is performed for 30 seconds.
- When CD Text Search is made during M.I.X. play, the M.I.X. play mode will be canceled.

## File/Folder Name Search (Concerning MP3/WMA/AAC)

Folder and file names may be searched and displayed during playback.

- 1 During MP3/WMA/AAC playback, press /ENT to activate the search mode.**
- 2 Turn the Rotary encoder to select Folder Name Search mode or File Name Search mode, and then press /ENT.**

### Folder Name Search mode

- 3 Turn the Rotary encoder to select the desired folder.**
- 4 Press and hold /ENT for at least 2 seconds to play back the first file in the selected folder.**

- Press and hold /ESC for at least 2 seconds in the search mode to cancel. Or, the search mode is canceled if no operation is performed for 30 seconds.
- To search for files in the Folder Name Search mode, press /ENT. Files in the folder may be searched.
- Press /ESC to exit Folder Name Search mode in step 3 in order to select File Name Search mode.
- The root folder is displayed as "-----".
- When Folder Name Search is made during M.I.X. play, the M.I.X. play mode will be canceled.

### File Name Search mode

- 3 Press or to select another Folder.**
- 4 Select the desired file by turning the Rotary encoder.**
- 5 Press /ENT to play back the selected file.**

- Press and hold /ESC for at least 2 seconds in the search mode to cancel. Or, the search mode is canceled if no operation is performed for 30 seconds.
- Press /ESC in the search mode to return to the previous mode.
- When File Name Search is made during M.I.X. play, the M.I.X. play mode will be canceled.

---

## Quick Search

---

You can search for tracks (files).

**1** Press and hold **Q/ENT** for at least 2 seconds in the **CD/Changer/MP3/WMA/AAC** mode to activate **Quick Search** mode.

**2** Turn the **Rotary encoder** to select a desired track (file).

The selected track is played back immediately.

- Press **↵/ESC** in the search mode to cancel. Or, the search mode is canceled if no operation is performed for 10 seconds.

---

## About MP3/WMA/AAC

---

### CAUTION

*Except for private use, duplicating audio data (including MP3/WMA/AAC data) or distributing, transferring, or copying it, whether for free or for a fee, without permission of the copyright holder is strictly prohibited by the Copyright Act and by international treaty.*

### What is MP3?

MP3, whose official name is "MPEG-1 Audio Layer 3," is a compression standard prescribed by the ISO, the International Standardization Organization and MPEG which is a joint activity institution of the IEC.

MP3 files contain compressed audio data. MP3 encoding is capable of compressing audio data at extremely high ratios, reducing the size of music files to as much as one-tenth their original size. This is achieved while still maintaining near CD quality. The MP3 format realizes such high compression ratios by eliminating the sounds that are either inaudible to the human ear or masked by other sounds.

### What is AAC?

AAC is the abbreviation for "Advanced Audio Coding", and is a basic format of audio compression used by MPEG2 or MPEG4.

### What is WMA?

WMA, or "Windows Media™ Audio," is compressed audio data. WMA is similar to MP3 audio data and can achieve CD quality sound with small file sizes.

### Method for creating MP3/WMA/AAC files

Audio data is compressed using software with MP3/WMA/AAC codecs. For details on creating MP3/WMA/AAC files, refer to the user's manual for that software.

MP3/WMA/AAC files that are playable on this device have the file extensions.

MP3: "mp3"

WMA: "wma" (ver. 7.1, 8 and 9 are supported)

AAC: "m4a"

There are many different versions of the AAC format. Confirm that the software being used conforms to the acceptable formats listed above. It's possible that the format may be unplayable even though the extension is valid.

Playback of AAC files encoded by iTunes is supported.

### Supported playback sampling rates and bit rates

#### MP3

Sampling rates: 48 kHz, 44.1 kHz, 32 kHz, 24 kHz, 22.05 kHz, 16 kHz, 12 kHz, 11.025 kHz, 8 kHz

Bit rates: 8 - 320 kbps

#### WMA

Sampling rates: 48 kHz, 44.1 kHz, 32 kHz

Bit rates: 48 - 192 kbps

#### AAC

Sampling rates: 48 kHz, 44.1 kHz, 32 kHz, 24 kHz, 22.05 kHz, 16 kHz, 12 kHz, 11.025 kHz, 8 kHz

Bit rates: 16 - 320 kbps

This device may not play back correctly depending on sampling rates.

In the USB mode, the playback time may not be correctly displayed when a VBR (Variable Bit Rate) recorded file is played back.

### ID3 tags/WMA tags

This device supports ID3 tag v1 and v2, and WMA tag.

If tag data is in an MP3/WMA/AAC file, this device can display the title (track title), artist name, and album name ID3 tag/WMA tag data.

This device can only display single-byte alphanumeric characters (up to 30 for ID3 tags and up to 15 for WMA tags) and the underscore. For non-supported characters, the display is NO SUPPORT.

If information contains characters other than ID3 tag information, the audio file may not be played back.

The tag information may not be correctly displayed, depending on the contents.

### Playing back MP3/WMA/AAC

MP3/WMA/AAC files are prepared, then written to a CD-R, CD-RW using CD-R writing software or stored to a USB memory. A disc can hold up to 510 files/folders (including Root Folders), and the maximum number of folders is 255. This unit can recognize at least 100 folders (including root folder) and 100 files per folder stored in USB memory.

Playback may not be performed if a disc or USB memory exceeds the limitations described above.

Do not make a file's playback time more than 1 hour.

### Media supported

The media that this device can play back are CD-ROMs, CD-Rs, and CD-RWs.

This device also can play back USB memory media.

### Corresponding File Systems

This device supports discs formatted with ISO9660 Level 1 or Level 2.

Under the ISO9660 standard, there are some restrictions to remember.

The maximum nested folder depth is 8 (including the root directory). The number of characters for a folder/file name is limited.

Valid characters for folder/file names are letters A-Z (all caps), numbers 0-9, and '\_' (underscore).

This device also can play back discs in Joliet, Romeo, etc., and other standards that conform to ISO9660. However, sometimes the file names, folder names, etc., are not displayed correctly.

This device also supports FAT 12/16/32 for USB memory device.

### Formats supported

This device supports CD-ROM XA, Mixed Mode CD, Enhanced CD (CD-Extra) and Multi-Session.

This device cannot correctly play back discs recorded with Track At Once or packet writing.

## Order of files

Files are played back in the order that the writing software writes them to the disc. Therefore, the playback order may not be what is expected. Verify the writing order in the software's documentation. The playback order of the folders and files is as follows.

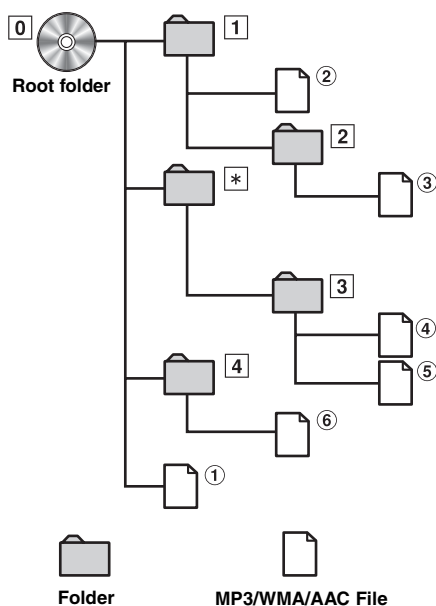

\* The folder No./ folder Name will not be displayed if no file is contained in the folder.

## Terminology

### Bit rate

This is the "sound" compression rate specified for encoding. The higher the bit rate, the higher the sound quality, but also the larger the files.

### Sampling rate

This value shows how many times per second the data is sampled (recorded). For example, music CDs use a sampling rate of 44.1 kHz, so the sound is sampled (recorded) 44,100 times per second. The higher the sampling rate, the higher the sound quality, but also the larger the volume of data.

### Encoding

Converting music CDs, WAVE (AIFF) files, and other sound files into the specified audio compression format.

### Tag

Song information such as track titles, artist names, album names, etc., written into MP3/WMA/AAC files.

### Root folder

The root folder (or root directory) is found at the top of the file system. The root folder contains all folders and files. It is created automatically for all burned discs.

# Sound Setting

## SOURCE/⏻ Rotary encoder (AUDIO/LOUD)

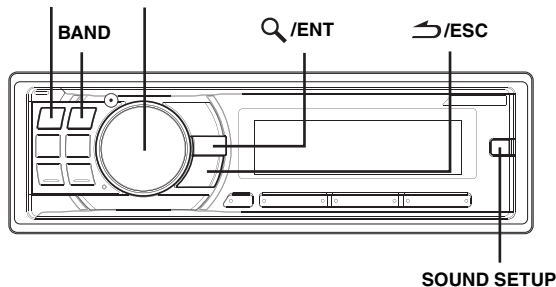

## Adjusting Subwoofer Level/Bass Level/Treble Level/Balance (Between Left and Right)/Fader (Between Front and Rear)/Defeat

### 1 Press Rotary encoder (AUDIO) repeatedly to choose the desired mode.

Each press changes the mode as follows:

SUBW LEVEL\* → BASS LEVEL → TREBLE LEVEL →  
BALANCE → FADER → DEFEAT → VOLUME →  
SUBW LEVEL

Subwoofer level: 0 ~ +15

Bass level: -7 ~ +7

Treble level: -7 ~ +7

Balance: L15 ~ R15

Fader: R15 ~ F15

Defeat: ON/OFF

Volume: 0 ~ 35

- If no operation is performed for 5 seconds after selecting the SUBW LEVEL, BASS LEVEL, TREBLE LEVEL, BALANCE, FADER or DEFEAT mode, the unit automatically returns to normal mode.

\* When the subwoofer mode is set to OFF, its level cannot be adjusted. Refer to "Turning Subwoofer ON/OFF" (page 14).

### 2 Turn the Rotary encoder until the desired sound is obtained in each mode.

By setting DEFEAT ON, previously adjusted settings of BASS and TREBLE will return to the factory defaults.

- Depending on the connected devices, some functions and display indications do not work.

## Setting the Subwoofer Level

You can change the Subwoofer Level to create your own tonal preference.

**1 Press SOUND SETUP to activate the Sound Setting mode.**

**2 Turn the Rotary encoder to select the SUBW LEVEL Adjustment mode, and then press Q/ENT.**

SUBW LEVEL\*<sup>1</sup> ↔ BASS\*<sup>2</sup> ↔ TREBLE\*<sup>2</sup> ↔ HPF\*<sup>2</sup>  
↔ SUBW LEVEL

**3 Turn the Rotary encoder to select the desired subwoofer level (0~+15).**

- If no operation is performed for 15 seconds, the unit will return to normal mode automatically.
- When subwoofer is set to OFF and DEFEAT is set to ON, pressing the SOUND SETUP button momentarily will not be functional.

\*<sup>1</sup> When the subwoofer mode is set to OFF, its level cannot be adjusted, refer to “Turning Subwoofer ON/OFF” (page 14).

The adjustment can also be made by pressing **Rotary encoder (AUDIO)**. Refer to “Adjusting Subwoofer Level/Bass Level/Treble Level/Balance (Between Left and Right)/Fader (Between Front and Rear)/Defeat” (page 12).

\*<sup>2</sup> The function is inoperable when DEFEAT is set to ON.

## Setting the Bass Control

You can change the Bass Frequency emphasis to create your own tonal preference.

**1 Press SOUND SETUP to activate the Sound Setting mode.**

**2 Turn the Rotary encoder to select the BASS Adjustment mode, and then press Q/ENT.**

SUBW LEVEL\*<sup>3</sup> ↔ BASS\*<sup>4</sup> ↔ TREBLE\*<sup>4</sup> ↔ HPF\*<sup>4</sup>  
↔ SUBW LEVEL

## Setting the Bass Center Frequency

**3-1 Press BAND to select the desired bass center frequency.**

80 Hz → 100 Hz → 200 Hz → 60 Hz → 80 Hz

Emphasizes the displayed bass frequency ranges.

## Setting the Bass Bandwidth

**3-2 Press SOURCE/⏻ to select the desired bass bandwidth.**



Changes the boosted bass bandwidth to wide or narrow. A wider setting will boost a wide range of frequencies above and below the center frequency. A narrower setting will boost only frequencies near the center frequency.

## Setting the Bass Level

**3-3\*<sup>5</sup> Turn the Rotary encoder to select the desired bass level (-7~+7).**

You can emphasize or weaken the bass level.

**4 Press and hold ↵/ESC for at least 2 seconds to return to normal mode.**

- If no operation is performed for 15 seconds, the unit will return to normal mode automatically.
- The bass level settings will be individually memorized for each source (FM, AM, CD, etc.) until the setting is changed. The bass frequency and bass bandwidth settings adjusted for one source are effective for all other sources (FM, AM, CD, etc.).
- Depending on the connected devices, some functions and display indications do not work. However, Bass Level is still adjustable if an audio processor with the Bass function is connected.
- When subwoofer is set to OFF and DEFEAT is set to ON, pressing the SOUND SETUP button momentarily will not be functional.

\*<sup>3</sup> When the subwoofer mode is set to OFF, its level cannot be adjusted. Refer to “Turning Subwoofer ON/OFF” (page 14).

\*<sup>4</sup> The function is inoperable when DEFEAT is set to ON.

\*<sup>5</sup> The adjustment can also be made by pressing **Rotary encoder (AUDIO)**. Refer to “Adjusting Subwoofer Level/Bass Level/Treble Level/Balance (Between Left and Right)/Fader (Between Front and Rear)/Defeat” (page 12).

## Setting the Treble Control

You can change the Treble Frequency emphasis to create your own tonal preference.

**1 Press SOUND SETUP to activate the Sound Setting mode.**

**2 Turn the Rotary encoder to select the TREBLE Adjustment mode, and then press Q/ENT.**

SUBW LEVEL\*<sup>6</sup> ↔ BASS\*<sup>7</sup> ↔ TREBLE\*<sup>7</sup> ↔ HPF\*<sup>7</sup>  
↔ SUBW LEVEL

## Setting the Treble Center Frequency

**3-1 Press BAND to select the desired treble center frequency.**

10.0 kHz → 12.5 kHz → 15.0 kHz → 17.5 kHz → 10.0 kHz

Emphasizes the displayed treble frequency ranges.

## Setting the Treble Level

**3-2\*<sup>8</sup> Turn the Rotary encoder to select the desired treble level (-7~+7).**

You can emphasize or weaken the treble level.

**4 Press and hold ↵/ESC for at least 2 seconds to return to normal mode.**

- If no operation is performed for 15 seconds, the unit will return to normal mode automatically.
- The treble level settings will be individually memorized for each source (FM, AM, CD, etc.) until the setting is changed. The Treble frequency settings adjusted for one source are effective for all other sources (FM, AM, CD, etc.).

- Depending on the connected devices, some functions and display indications do not work. However, Treble Level is still adjustable if an audio processor with the Treble function is connected.
- When subwoofer is set to OFF and DEFEAT is set to ON, pressing the SOUND SETUP button momentarily will not be functional.

\*<sup>6</sup> When the subwoofer mode is set to OFF, its level cannot be adjusted. Refer to “Turning Subwoofer ON/OFF” (page 14).

\*<sup>7</sup> The function is inoperable when DEFEAT is set to ON.

\*<sup>8</sup> The adjustment can also be made by pressing **Rotary encoder (AUDIO)**. Refer to “Adjusting Subwoofer Level/Bass Level/Treble Level/Balance (Between Left and Right)/Fader (Between Front and Rear)/Defeat” (page 12).

## Adjusting the High Pass Filter

The High Pass Filter on this unit can be adjusted to suit your personal taste.

**1 Press SOUND SETUP to activate the Sound Setting mode.**

**2 Turn the Rotary encoder to select the High Pass Filter (HPF) Adjustment mode, and then press Q/ENT.**

SUBW LEVEL\*<sup>9</sup> ↔ BASS\*<sup>10</sup> ↔ TREBLE\*<sup>10</sup> ↔ HPF\*<sup>10</sup>  
↔ SUBW LEVEL

**3 Turn the Rotary encoder to select the High Pass Filter frequency.**

OFF ↔ 60 Hz ↔ 80 Hz ↔ 100 Hz

**4 Press and hold ↵/ESC for at least 2 seconds to return to normal mode.**

- If no operation is performed for 15 seconds, the unit will return to normal mode automatically.
- When an external audio processor is connected, this setting cannot be made.
- When subwoofer is set to OFF and DEFEAT is set to ON, pressing the SOUND SETUP button momentarily will not be functional.

\*<sup>9</sup> When the subwoofer mode is set to OFF, its level cannot be adjusted. Refer to “Turning Subwoofer ON/OFF” (page 14).

\*<sup>10</sup> The function is inoperable when DEFEAT is set to ON.

## Turning Loudness On/Off

Loudness introduces a special low-and high-frequency emphasis at low listening levels. This compensates for the ear’s decreased sensitivity to bass and treble sound.

**Press and hold Rotary encoder (LOUD) for at least 2 seconds to activate or deactivate the loudness mode.**

- When an external audio processor is connected, this setting cannot be made.
- The function is inoperable when DEFEAT is set to ON.

## Turning Subwoofer ON/OFF

When the subwoofer is on, you can adjust the subwoofer output level (refer to page 13).

**1 Press and hold SOUND SETUP for at least 2 seconds to activate the Subwoofer selection mode.**

**2 Turn the Rotary encoder to select the SUBWOOFER mode, and then press Q/ENT.**

SUBWOOFER ↔ SUBW SYSTEM\*<sup>11</sup> ↔ SUBWOOFER

**3 Turn the Rotary encoder to select SUBW ON/OFF, and then press Q/ENT.**

SUBW ON (Initial setting) ↔ SUBW OFF

**4 Press and hold ↵/ESC for at least 2 seconds to return to normal mode.**

- If no operation is performed for 15 seconds, the unit will return to normal mode automatically.

\*<sup>11</sup> Displayed only when SUBWOOFER is set to ON.

## Setting the Subwoofer System

When the subwoofer is on, you can select either System1 or System2 for the desired subwoofer effect.

**1 Press and hold SOUND SETUP for at least 2 seconds to activate the Subwoofer selection mode.**

**2 Turn the Rotary encoder to select the SUBW SYSTEM mode, and then press Q/ENT.**

SUBWOOFER ↔ SUBW SYSTEM ↔ SUBWOOFER

**3 Turn the Rotary encoder to select SUBW SYS 1 or SUBW SYS 2, and then press Q/ENT.**

Select either SYS 1 or SYS 2 for the desired subwoofer effect.

SUBW SYS 1 (Initial setting) ↔ SUBW SYS 2

SUBW SYS 1: Subwoofer level changes according to the main volume setting.

SUBW SYS 2: Subwoofer level change is different from the main volume setting. For example, even at low volume settings, the subwoofer is still audible.

**4 Press and hold ↵/ESC for at least 2 seconds to return to normal mode.**

- If no operation is performed for 15 seconds, the unit will return to normal mode automatically.
- This function is inoperable when SUBWOOFER is set to OFF.



# Other Functions

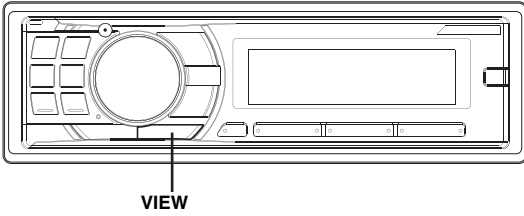

VIEW

## Displaying the Text

Text information, such as the disc name and the track name, will be displayed if playing a CD text compatible disc. It is also possible to display the folder name, the file name, and the tag, etc., while playing MP3/WMA/AAC files.

### Press VIEW.

The display will change every time the button is pressed.

- When the TEXT SCROLL is set to SCROLL MANU, press and hold VIEW for at least 2 seconds, the current text will be scrolled one time (except Radio mode).

### The display in Radio mode:

FREQUENCY → CLOCK → RADIO STATION NAME\*<sup>1/2</sup> → ARTIST NAME\*<sup>1</sup> → ALBUM NAME\*<sup>1</sup> → SONG NAME\*<sup>1</sup> → FREQUENCY

### The display in CD mode:

TRACK NO./ELAPSED TIME → TRACK NO./CLOCK → TEXT (DISC NAME)\*<sup>3</sup> → TEXT (TRACK NAME)\*<sup>3</sup> → TRACK NO./ELAPSED TIME

### The display in MP3/WMA/AAC mode:

FILE NO./ELAPSED TIME → FOLDER NO./FILE NO. → FILE NO./CLOCK → FOLDER NAME\*<sup>4</sup> → FILE NAME → ARTIST NAME\*<sup>5</sup> → ALBUM NAME\*<sup>5</sup> → SONG NAME\*<sup>5</sup> → FILE NO./ELAPSED TIME

### The display in Bluetooth Audio mode:

The Following display will be shown only when a telephone or Bluetooth Streaming device with Metadata capabilities is correctly connected with a Bluetooth INTERFACE (KCE-400BT). For details, refer to the Owner's Manual of the Bluetooth INTERFACE (KCE-400BT).

BT AUDIO → CLOCK → ARTIST NAME\*<sup>6</sup> → ALBUM NAME\*<sup>6</sup> → SONG NAME\*<sup>6</sup> → BT AUDIO

\*<sup>1</sup> When an HD signal is received, text information such as radio station, artist, etc., is displayed.

If there is no text information, "ARTIST"/"ALBUM"/"SONG"/"STATION" will be displayed.

\*<sup>2</sup> RADIO STATION NAME can be switched between "LONG" and "SHORT" in "HD Radio Station Call Setting (STATION CALL)" (page 18).

\*<sup>3</sup> Displayed during playback of a disc with CD Text.

If there is no Text (Disc Name or Track Name), "DISC TEXT"/"TRACK TEXT" is displayed. "DISC TEXT"/"TRACK TEXT" is displayed for changer.

\*<sup>4</sup> The root folder of disc is displayed as "FOLDER". The root folder of USB memory is displayed as "ROOT".

\*<sup>5</sup> ID3 tag/WMA tag

If an MP3/WMA/AAC file contains ID3 tag/WMA tag information, the ID3 tag/WMA tag information is displayed (e.g., song name, artist name, and album name). All other tag data is ignored.

If the Scroll Setting (page 17) is set to "SCROLL AUTO," the tag information will scroll automatically.

If there is no tag information, "ARTIST"/"ALBUM"/"SONG" is displayed.

\*<sup>6</sup> When a BT AUDIO signal is received, text information such as artist, album, song is displayed.

If there is no text information, "ARTIST"/"ALBUM"/"SONG" will be displayed.

## About the indication display

When displaying Text, the following indicators are lit according to the mode.

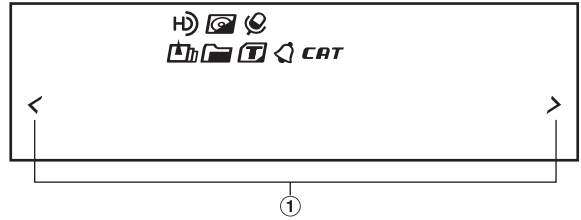

- ① Lights up in SETUP mode, search mode and sound setting mode, etc.

Indicator/ Mode	CD Mode	MP3/WMA/ AAC/USB AUDIO Mode	SAT RADIO/ HD RADIO Mode	iPhone/ iPod/BT AUDIO Mode
	—	Folder Name being displayed	—	—
	—	Artist Name being displayed	Artist Name being displayed	Artist Name being displayed
	Text (Disc Name) being displayed	Album Name being displayed	Album Name being displayed (HD Radio mode only)	Album Name being displayed
	Text (Track Name) being displayed	Song Name/ File Name being displayed	Song Title/ Channel Name being displayed	Song Name being displayed
<b>CAT</b>	—	—	Category Search being displayed (XM/SIRIUS only)	—
	—	—	Alert being displayed (SIRIUS Radio only)	—
	—	—	SPS being displayed (HD Radio mode only)	—
	—	—	HD Radio signal being received (HD Radio mode only)	—

## About "Text"

### Text:

Text compatible CDs contain text information such as the disc name and track name. Such text information is referred to as "text".

- Some characters may not be displayed correctly with this device, depending on the character type.
- The CD changer must also be CD Text compatible for the Text information to be displayed.
- The text or tag information may not be correctly displayed, depending on the contents.

## Displaying Time

Press **VIEW** repeatedly until the time is displayed.

Each press changes the display.  
For details, see "Displaying the Text" (page 15).

- Selecting any tuner or CD function while in the clock priority mode will interrupt the time display momentarily. The function selected will be displayed for about 5 seconds before the time returns to the display.
- When the power is off but the ignition key is on, press **VIEW** to display or turn off the time.

# SETUP

You can flexibly customize the unit to suit your own preferences and usage. From the **SETUP** menu, Visual Customizing, External Device, etc., can be modified.

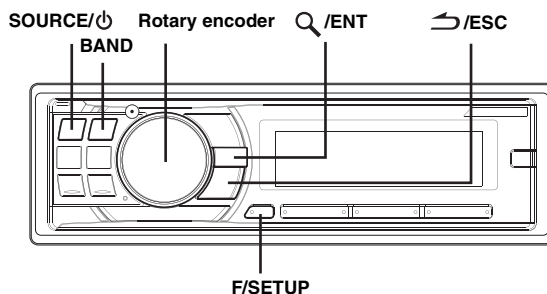

**Use steps 1 to 4 to select one of the **SETUP** modes to modify. See the applicable section below for details about the selected **SETUP** item.**

- 1 Press and hold **F/SETUP** for at least 2 seconds to activate the **SETUP** mode.**
- 2 Turn the **Rotary encoder** to select the desired item, and then press **Q/ENT**.**

(e.g. Select **POWER IC**)

BLUETOOTH IN\*<sup>1</sup> ↔ ILLUMINATION ↔ LCD CONTRAST ↔ DIMMER ↔ PLAY MODE ↔ SCROLL TYPE ↔ TEXT SCROLL ↔ INT MUTE\*<sup>2</sup> ↔ CLOCK ADJUST\*<sup>3</sup> ↔ AUX+ SETUP ↔ AUX+ NAME\*<sup>4</sup> ↔ AUX IN GAIN\*<sup>4</sup> ↔ DIGITAL AUX ↔ D-AUX NAME\*<sup>5</sup> ↔ AUX IN ↔ AUX NAME\*<sup>6</sup> ↔ CHANGER NAME ↔ POWER IC ↔ LANGUAGE ↔ XM ADF\*<sup>7</sup> ↔ GAME ALERT\*<sup>8</sup> ↔ STATION CALL\*<sup>9</sup> ↔ DIGITAL SEEK\*<sup>9</sup> ↔ DEMO ↔ BLUETOOTH IN

\*<sup>1</sup> Displayed only when **INT MUTE** is **OFF**, and the mode is set to other than **BT AUDIO**.

\*<sup>2</sup> Displayed only when **BLUETOOTH IN** is **OFF**.

\*<sup>3</sup> Refer to "Setting the Time" (page 7).

\*<sup>4</sup> Displayed only when **AUX+ SETUP** is **ON**.

\*<sup>5</sup> Displayed only when **DIGITAL AUX** is **ON**.

\*<sup>6</sup> Displayed only when **AUX IN** is **ON**.

\*<sup>7</sup> When **XM** is connected, refer to "Setting the Auxiliary Data Field Display (**XM** only)" (page 22).

\*<sup>8</sup> When **SIRIUS** is connected, refer to "Game Alert Setup" (page 20).

\*<sup>9</sup> When **HD Radio Tuner** module is connected.

- 3 Turn the **Rotary encoder** to change the setting, and then press **Q/ENT**.**

(e.g. Select **POWER IC ON** or **POWER IC OFF**)

- 4 Press and hold **F/SETUP** for at least 2 seconds to return to normal mode.**

- Pressing **↵/ESC** returns to the previous **SETUP** mode.
- If no operation is performed for 60 seconds, **SETUP** is canceled.

## BLUETOOTH IN

### Setting the Bluetooth Connection

#### BT IN ADAPTE / BT IN OFF (Initial Setting)





If an optional Bluetooth INTERFACE (KCE-400BT) is connected, you can place a hands-free call by a Bluetooth- equipped mobile phone. Make this setting when the Bluetooth INTERFACE (KCE-400BT) is connected and the Bluetooth function is used. For details, refer to the Owner's Manual of the optional Bluetooth INTERFACE (KCE-400BT). Set ADAPTE when the Bluetooth INTERFACE (KCE-400BT) is connected.

- The  button can be used only when the optional Bluetooth INTERFACE (KCE-400BT) is connected.
- If the mobile phone compatible with the Voice Dial function is connected, the Voice Dial function can be used.

## Visual Customizing

### Changing Lighting Color

#### ILLUMI TYPE1 (initial setting) / ILLUMI TYPE2

You can change the lighting color of the following six buttons. SOURCE/, BAND, , , , .

TYPE1: When the color of the six buttons is blue, the color of the other is red.

TYPE2: When the color of the six buttons is red, the color of the other is red.

### Adjusting Display Contrast

#### CONTRAST

You can adjust the display contrast for better visibility.

You can adjust in a range of -5 and +3.

- The initial setting at the factory is "0".

### Dimmer Control

#### DIMMER AUTO (Initial setting) / DIMMER MANU

Set the DIMMER control to AUTO to decrease the illumination brightness of the unit with the head lights of the vehicle ON. This mode is useful if you feel the unit's backlighting is too bright at night.

### Scroll Type Setting

#### SCROLL TYPE1 / SCROLL TYPE2 (Initial setting)

Choose from two scrolling methods. Select the type you prefer.

SCROLL TYPE1: The characters scroll from right to left, one character at a time.

SCROLL TYPE2: Words are built up from left to right, a single character at a time. When the display is full, it is cleared and the subsequent words are displayed the same way until all words of the title have been shown.

### Scroll Setting (TEXT SCROLL)

#### SCROLL AUTO / SCROLL MANU (Initial setting)

This CD player can scroll the disc and track names recorded on CD-TEXT discs, as well as the text information of MP3/WMA/AAC files, folder names and tags.

SCROLL AUTO: CD text information, folder and file names, HD and SAT Radio text are scrolled continuously. In addition, all tag information is automatically rotated in the display continuously, without pressing the VIEW button.

SCROLL MANU: The above information is scrolled only when a disc is loaded, a channel or track is changed, etc.

- The unit scrolls CD text names, folder names, file names or tag display.

### Setting the Language Font

#### LANGUAGE 1 (initial setting) / LANGUAGE 2

Two types of font can be selected.

LANGUAGE 1: Normal font

LANGUAGE 2: European font

### Demonstration

#### DEMO ON / DEMO OFF (Initial setting)

This unit has a demonstration feature for the display.

- To quit Demo mode, set to DEMO OFF.

## MP3/WMA/AAC

### Playing MP3/WMA/AAC Data (PLAY MODE)

#### CD-DA (Initial setting) / CD-DA&MP3

This unit can play back CDs containing both CD and MP3 /WMA/AAC data (created in Enhanced CD (CD Extra) format). However, in some situations, playback of an enhanced CD may be difficult. In this case, you can select playback of a single session only, containing the CD data. When a disc contains both CD and MP3/WMA/AAC data, playback starts from the CD data portion of the disc.

CD-DA: Only the CD data in Session 1 can be played back.

CD-DA&MP3: CD data, MP3/WMA/AAC files in mixed mode, and multi-session discs can be played back.

- Perform this setting before inserting a disc. If a disc has already been inserted, remove it first. (If you use an MP3 changer, you have to change discs.)

## External Device

### Connecting to an External Amplifier

#### POWER IC ON (Initial setting) / POWER IC OFF

When an external amplifier is connected, sound quality can be improved by stopping the power supply of the built-in amplifier.

POWER IC OFF: Use this mode when the line output of this unit is used to drive an external amplifier. In this setting, the head unit's internal amplifier is turned OFF and can not drive speakers.

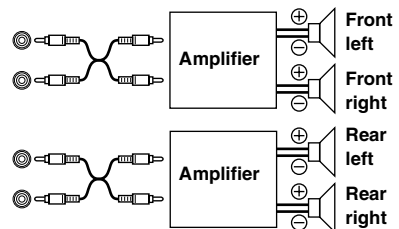

**POWER IC ON:** The speakers are driven by the built-in amplifier.

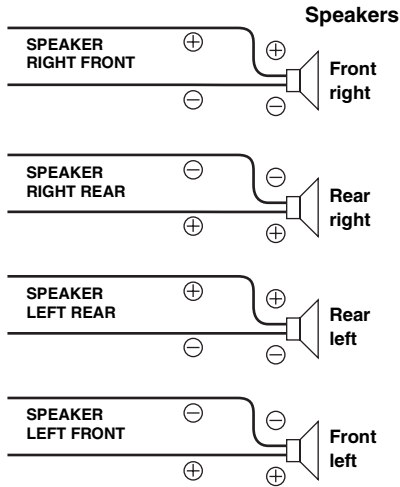

- No sound is produced by the system when the power output is set to OFF.

### **Turning Mute Mode On/Off (INT MUTE)** **MUTE ON / MUTE OFF (Initial setting)**

If a device having the interrupt feature is connected, audio will be automatically muted whenever the interrupt signal is received from the device.

### **Setting the AUX+ SETUP Mode** **AUX+ ON / AUX+ OFF (Initial Setting)**

You can input the audio of an external device, (such as a Portable audio player) to the Bluetooth interface connector of this unit. A special Conversion cable (KCE-237B) is necessary to adapt the Bluetooth interface connector as an AUX IN.

A portable music device and a Bluetooth INTERFACE (KCE-400BT) cannot be connected to the Bluetooth interface connector at the same time.

**AUX+ ON:** Set to ON when a portable device is connected. If **SOURCE/⏻** is pressed and AUX+ is selected, the sound of the portable device is input to the unit.

**AUX+ OFF:** When set to OFF, AUX+ source cannot be selected.

You can change the AUX+ NAME display when AUX+ SETUP is set to ON. Press **Q/ENT** when AUX+ SETUP is set to ON, and select AUX+ NAME by turning the **Rotary encoder**, then press **Q/ENT**. After that, turn the **Rotary encoder** to select the desired AUX+ NAME.

### **Setting the AUX+ Level (AUX IN GAIN)** **LOW (Initial setting) / HIGH**

After setting to ON in "Setting the AUX+ SETUP Mode", this setting can be carried out.

**LOW:** Decreases the external input audio level.  
**HIGH:** Increases the external input audio level.

### **Setting the External Digital Input**

#### **D-AUX ON / D-AUX OFF (Initial setting)**

When an ALPINE Ai-NET compatible digital audio processor (PXA-H701) and a DVD player (DVE-5207) not compatible with Ai-NET are connected, set D-AUX to ON to enjoy 5.1-channel surround sound.

You can change the D-AUX NAME display when D-AUX is set to ON. Press **Q/ENT** when D-AUX is set to ON, and select D-AUX NAME by turning the **Rotary encoder**, then press **Q/ENT**. After that, turn the **Rotary encoder** to select the desired D-AUX NAME.

- Press **SOURCE/⏻**, and select the **DIGITAL-AUX** mode, and adjust the volume, etc.
- After input selection is completed, turn the ignition off and back on again. Setting of the optical digital input switch is completed.
- Depending on the connected audio processor, DVD player sound may continue to be output, even though the source is changed to another one. If this occurs, set the DVD player's power to OFF.

### **Setting the AUX Mode (V-Link)**

#### **AUX IN ON / AUX IN OFF (Initial setting)**

You can input TV/video sound by connecting an optional Ai-NET/RCA Interface cable (KCA-121B) or Versatile Link Terminal (KCA-410C) to this component.

You can change the AUX name display when AUX IN is set to ON. Press **Q/ENT** when AUX IN is set to ON, and select AUX NAME by turning the **Rotary encoder**, and then press **Q/ENT**.

After that, turn the **Rotary encoder** to select the desired AUX name.

If the KCA-410C is connected, it is possible to select two AUX names.

- Via KCA-410C, up to 2 external devices with RCA output can be connected. In this case, press **SOURCE/⏻** to select AUX mode and then press **BAND** to select your desired device.

### **Changer Name Setting**

#### **CHANGER (Initial Setting) / USB / PORTABLE**

This setting is used when the head unit is connected to the USB Adapter for MP3 (KCA-620M). You can set the name to be displayed on the unit depending on the device to which the USB Adapter for MP3 (KCA-620M) is connected.

### **HD Radio Reception (only when HD Radio Tuner module is connected)**

#### **HD Radio Station Call Setting (STATION CALL)**

##### **SHORT (Initial setting) / LONG**

In the HD Radio mode, the number of display characters for the HD Radio station name can be selected.

**SHORT:** 7 characters (FM)  
4 characters (AM)  
**LONG:** 56 characters

#### **Digital Seek ON/OFF Setting**

##### **DIG SEEK ON / DIG SEEK OFF (Initial Setting)**

**ON:** SEEK UP/DOWN is used only for Digital Radio Station.  
**OFF:** SEEK UP/DOWN is used for all Radio Stations.

# SAT Radio Receiver (Optional)

SOURCE/⏻ Rotary encoder

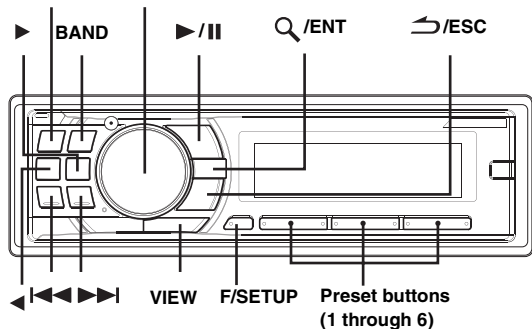

**SAT Receiver:** XM or SIRIUS Receiver  
When an optional XM or SIRIUS Receiver Box is connected via the Ai-NET bus, the following operations may be performed. However, the XM Receiver and SIRIUS Receiver cannot be connected at the same time.

**SIRIUS Receiver:** Verify the features of the connected SIRIUS Receiver Box. Not all SIRIUS Receivers have identical functions and some may not be performed on this unit. For details about functions, refer to the SIRIUS Receiver's Owner's Manual.

## Receiving Channels with the SAT Radio Receiver (Optional)

### About SAT Radio

Satellite Radio\* is the next generation of audio entertainment, with over 100 digital audio channels. For a small monthly fee, subscribers can hear crystal-clear music, sports, news and talk, coast-to-coast via satellite. For more information, visit XM's website at [www.xmradio.com](http://www.xmradio.com), or SIRIUS' website at [www.sirius.com](http://www.sirius.com).

To receive SAT Radio, the separately sold XM Direct™ or SIRIUS Satellite Radio Tuner and an appropriate Ai-NET Interface Adapter will be required. For details, consult you nearest Alpine dealer.

\* XM and its corresponding logos are trademarks of XM Satellite Radio Inc.

\* SIRIUS and its corresponding logos are trademarks of SIRIUS Satellite Radio Inc.

• The SAT Receiver controls on this unit are operative only when a SAT Receiver is connected.

**1 Press SOURCE/⏻ to activate the SAT Radio mode.**

**2 Press BAND to select one of the three SAT Radio Preset Bands.**

Each press changes the band:

XM mode:

X1 → X2 → X3 → X1

SIRIUS mode:

S1 → S2 → S3 → S1

**3 Press ◀ or ▶ to select desired category.**

**4 Press ◀◀ or ▶▶ to select the desired channel.**

Holding down ◀◀ or ▶▶ will change channels continuously.

• When using the optional remote control (RUE-4190, etc.), an SAT Radio Channel can be directly called up with the numeric keypad of the remote control.

1 While in XM or SIRIUS Radio mode, enter the Channel number you want to call up with the numeric keypad on the remote control.

2 Press **Enter** on the remote control within 5 seconds to receive the Channel.

If the channel number is 3 digits, the Channel is automatically received after the channel number has been input.

## Checking the SAT Radio ID Number

A unique Radio ID number is required to subscribe to SAT Radio programming. Each third party XM or SIRIUS radio comes with this number.

This number is an 8 character (for XM Radio) or 12 character (for SIRIUS Radio) alphanumeric number. It is printed on a label found on the SAT Receiver.

It can also be displayed on the screen of this unit in the following way.

**XM:**

**1 While receiving a SAT Radio band, press ◀◀ or ▶▶ to select channel "0" for XM.**

The unit displays "CH 0" for 5 seconds, then alternately displays "RADIO ID" for 2 seconds and ID number for 10 seconds.

While displaying "RADIO ID" as shown above, Demonstration (page 17) become nonfunctional.

**2 To cancel the ID number display, select the channel other than "0".**

**SIRIUS:**

**1 While receiving a SAT Radio band, press ◀◀ or ▶▶ to select channel "255" or "0" for SIRIUS.**

**2 Press VIEW until the ID No. appears in the display.**

CHANNEL NO. → CATEGORY NAME → CHANNEL NAME → ID NO. → ID NO. → COMPOSER NAME → CLOCK → CHANNEL NO.

**3 To cancel the ID number display, set the channel to other than "255" and "0".**

• You cannot use "O", "S", "I", or "F" for the ID Number (XM radio Receiver only).

• You can check the ID number printed on a label on your third party, SAT Radio Receiver package.

## Storing Channel Presets

**1 Press BAND to select the desired band you want to store.**

**2 After tuning in the desired channel, press and hold, for at least 2 seconds, any one of the preset buttons (1 through 6) into which you wish to store the channel.**

The selected station is stored.

### 3 Repeat the procedure to store up to 5 other channels onto the same band.

- To use this procedure for other bands, simply select the band desired and repeat the procedure.
- A total of 18 channels can be stored in the preset memory for either XM or SIRIUS. 6 Channels are stored in each band (X1, X2 and X3 for XM; S1, S2 and S3 for SIRIUS).
- If you store a channel in a preset memory which already has a station, the current channel will be cleared and replaced with the new one.

## Receiving Stored Channels

- 1 Press **BAND** to select the desired band.
- 2 Press the channel preset button (1 through 6) that has your desired satellite channel in memory.

## Storing the desired Sports Team (SIRIUS only)

Store a favorite team from one of the available leagues SIRIUS covers. Once stored, game times and scores for that team are announced using the interruption ALERT display while receiving other programming. To receive these announcements, refer to page 20. This function becomes effective after performing the following two operations.

### Storing while receiving a game broadcast

- 1 Select the channel broadcasting your favorite team's game.
- 2 Press **F/SETUP** to activate the MEMORY/DELETE selection mode.
- 3 Turn the **Rotary encoder** to select the MEMORY mode, and then press **Q/ENT**.

MEMORY ↔ DELETE ↔ MEMORY

- 4 Turn the **Rotary encoder** to select the desired team for the game being broadcast, and then press **Q/ENT**.
- 5 Turn the **Rotary encoder** to select interruption type, and then press **Q/ENT**.

TYPE INITIAL ↔ TYPE UPDATE (Initial setting)

INITIAL: The ALERT display interrupts when the game begins.  
UPDATE: The ALERT display interrupts by game progress (change of score, game result, etc.).

- 6 Press and hold **↵/ESC** for at least 2 seconds to return to normal mode.

- If you try to store when the memory area is filled, "MEMORY FULL" is displayed. If you want to replace a team that's already been saved in step 4, turn the **Rotary encoder** to select "REPLACE YES", and then press **Q/ENT**.
- If no operation is performed for 10 seconds, the setting mode is canceled.

## Game Alert Setup

- 1 Press and hold **F/SETUP** for at least 2 seconds to enter the SETUP mode.
- 2 Turn the **Rotary encoder** to select GAME ALERT, and then press **Q/ENT**.
- 3 Turn the **Rotary encoder** to select the desired league, and then press **Q/ENT**.
- 4 Turn the **Rotary encoder** to select a team you want to store, and then press **Q/ENT**.
- 5 Turn the **Rotary encoder** to select an interruption type, and then press **Q/ENT**.

TYPE INITIAL ↔ TYPE UPDATE (Initial setting)

TYPE INITIAL: The ALERT display interrupts when the game begins.

TYPE UPDATE: The ALERT display interrupts by game progress (change of score, game result, etc.).

- 6 Press and hold **F/SETUP** for at least 2 seconds to cancel the SETUP mode.

- Pressing **↵/ESC** returns to the previous SETUP mode.
- If no operation is performed for 60 seconds, SETUP is canceled.
- In this mode, a total of 4 teams can be stored in the preset memory (one team per league).

## Storing the desired Song/Artist (SIRIUS only)

A stored song title or artist name is announced whenever a matching title or artist is found on another channel. The interruption ALERT is displayed while listening to a program on another channel. For receiving interruption information, refer to "Recalling the stored information (SIRIUS only)" (page 21).

- 1 Press **F/SETUP** to active the MEMORY/DELETE selection mode when a Song or the song of an Artist you want to store is being broadcast.
- 2 Turn the **Rotary encoder** to select the Memory mode, and then press **Q/ENT**.
- 3 Turn the **Rotary encoder** to select the SONG MEMORY or ARTIST MEMO, and then press **Q/ENT**.
- 4 Press and hold **↵/ESC** for at least 2 seconds to return to normal mode.



MEMORY ↔ DELETE

- If you try to store when the memory area is filled, "MEMORY FULL" is displayed. If you want to replace a Song title or Artist name that's already been saved in step 3, turn the **Rotary encoder** to select "REPLACE YES", and then press **Q/ENT**.
- If no operation is performed for 10 seconds, the setting mode is canceled.

## Recalling the stored information (SIRIUS only)

Whenever the stored sports team, song(s) or artist(s) are playing, an interruption ALERT appears in the display of the unit.

### 1 The interruption ALERT indicator is either on or blinking depending on the conditions listed below.

-  (ALERT) indicator lights: one Alert found.
-  (ALERT) indicator blinks: more than 2 Alerts found.

### If more than 2 Alerts are found (Blinking ALERT indicator)

### 2 Turn the Rotary encoder to select the desired information.

### 3 Press /ENT.

- If no operation is performed for 10 seconds, the unit returns to normal mode.
- Only a single sports team, song or artist can be displayed as an interruption ALERT. For example, both song and artist cannot be displayed as an ALERT at the same time.

## Canceling the stored Alert Memory (SIRIUS only)

### 1 During usual reception, press **F/SETUP** to active the MEMORY/DELETE selection mode.

### 2 Turn the Rotary encoder to select the Delete mode, and then press /ENT.

MEMORY ↔ DELETE ↔ MEMORY

The Memory List appears after DELETE MODE has been displayed.

### 3 Turn the Rotary encoder to select a list you want to delete, and then press /ENT.

### 4 Turn the Rotary encoder to select DELETE YES, and then press /ENT.

DELETE NO ↔ DELETE YES

Select "NO" the unit will return to the Memory List display.

### 5 Press and hold /ESC for at least 2 seconds to return to normal mode.

- If no operation is performed for 10 seconds, the setting mode is canceled.

## Search Function

You can search for programs by Category, Channel, Artist or Song.

### 1 Press /ENT in the XM or SIRIUS mode.

### 2 Turn the Rotary encoder to select Search mode, and then press /ENT.



CATEGORY ↔ CHANNEL ↔ ARTIST\* ↔ SONG\* ↔ CATEGORY

\* SIRIUS Only.

## Category Search mode





### 3 Turn the Rotary encoder to select the desired Category, and then press /ENT.

### 4 Turn the Rotary encoder to select the desired Channel Name, and then press /ENT.

- While in Category Search mode, press  /ESC to return to the selecting search mode.
- The Search mode is canceled if you press and hold  /ESC for at least 2 seconds, or no operation is performed for 10 seconds in Category Search mode.
- If ALERT interruption occurs in the search mode, the search mode is canceled.

## Channel/Artist/Song Search mode

### 3 Turn the Rotary encoder to select the desired Channel/Artist/Song Name, and then press /ENT.

- While in Channel Search mode, press  or  to select another Category.
- While in Channel/Artist/Song Search mode, press  /ESC to return to the selecting search mode.
- The Search mode is canceled if you press and hold  /ESC for at least 2 seconds, or no operation is performed for 10 seconds in Channel/Artist/Song Search mode.
- If ALERT interruption occurs in the search mode, the search mode is canceled.

## Quick Search Function

You can search for all channels in numerical order.

### 1 Press and hold /ENT for at least 2 seconds in XM or SIRIUS mode to activate Quick Search mode.

### 2 Turn the Rotary encoder to select the desired Channel within 10 seconds.

The selected Channel is received.

## Receiving Weather or Traffic Information from SAT Radio

### 1 Select the SAT Radio Channel for your local traffic/ weather information.

### 2 Press and hold /II for at least 2 seconds in the SAT mode.

The received weather or traffic channel is stored.

### 3 Press and hold **BAND** for at least 2 seconds.

The stored Weather or Traffic channel will be recalled.

### 4 Press and hold **BAND** for at least 2 seconds.

Returns to normal mode.

- Stored channels can also be recalled by pressing and holding **BAND** for at least 2 seconds.
- Channel other than Weather or Traffic can also be stored and recalled.

## Instant Replay Function (SIRIUS only)

In SIRIUS mode, the current channel is saved using the Instant Replay memory function. Use this function to pause the channel content at any time. When playback is continued, it will begin at the position it was paused. This function can be used to store up to 44 minutes of audio.

### 1 During SIRIUS reception, press ►/|| to select the Instant Replay mode.

"REPLAY MODE" is displayed, and the received station is stored.

### 2 Press ►/|| again to activate the play mode.

The stored contents are played back.

During REPLAY playback:

Fast rewind: Press and hold ◀◀◀.

Fast forward: Press and hold ▶▶▶.

Returning to the beginning of the current song: Press ◀◀◀.

Advancing to the beginning of the next song: Press ▶▶▶.

- If you continue to press Fast forward until the end, the INSTANT REPLAY mode is canceled, and the unit will change to usual reception.

### 3 Press ↵/ESC for at least 2 seconds to cancel the INSTANT REPLAY mode.

The unit returns to usual SIRIUS broadcasting mode.

Time display example during REPLAY playback (Instant Replay Mode only)

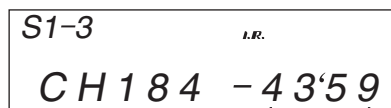

Play Time  
(Remaining time for  
INSTANT REPLAY)

## Changing the Display

Text information, such as the channel name, artist name/feature and song/program title, is available with each XM or Sirius channel. The unit can display this text information as explained below.

### In XM or SIRIUS mode, press VIEW.

Each time you press this button, the display changes as shown below.

CHANNEL No./(REMAINING TIME)\*1 → CATEGORY NAME →  
CHANNEL NAME → ARTIST NAME → SONG TITLE →  
COMPOSER NAME\*2 → AUXILIARY DATA FIELD\*3 →  
CLOCK → CHANNEL No./(REMAINING TIME)

\*1 Displayed only during instant replay.

\*2 SIRIUS mode only.

\*3 XM mode only:

When ADF is turned OFF, this information is not displayed (see "Setting the Auxiliary Data Field Display (XM only)" on page 22).

- When the "Scroll Setting (TEXT SCROLL)" (page 17) is set to "SCROLL AUTO", the display scrolls continuously. When the Scroll Setting is set to "SCROLL MANU", the display scrolls only once after any function is performed (PRESET, BAND, SEARCH, etc.). "CHANNEL No." and "CLOCK" displays do not scroll.
- Depending on the model, the display may differ from the one shown above.

## Setting the Auxiliary Data Field Display (XM only)

The XM Auxiliary Data Field (ADF) display can be switched on or off. There is no ADF function for the SIRIUS receiver.

### 1 Press and hold F/SETUP for at least 2 seconds to select the SETUP selection mode.

### 2 Turn the Rotary encoder to select the XM ADF mode, and then press Q/ENT.

### 3 Turn the Rotary encoder to select XM ADF ON/OFF, and then press Q/ENT.

When setting to ON, Auxiliary Data Field is displayed by pressing VIEW (Refer to the "Changing the Display" section on page 22).

### 4 Press and hold F/SETUP for at least 2 seconds to return to normal mode.

- Pressing ↵/ESC returns to the previous SETUP mode.
- If no operation is performed for 60 seconds, SETUP is canceled.



# USB memory (Optional)

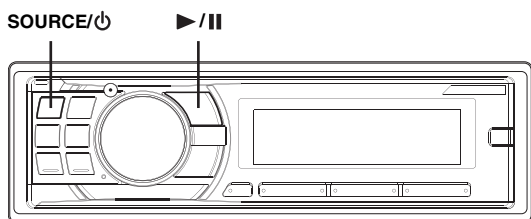

## Controlling USB memory (Optional)

A USB memory device may be connected to this unit. With a USB memory device connected to this unit, the audio files will be playable from this unit.

- The controls on this unit for USB memory operation are operative only when a USB memory is connected.

## Playing MP3/WMA/AAC Files with the USB memory (Optional)

If you connect a USB memory device containing MP3/WMA/AAC, these files are playable on this unit.

### 1 Press SOURCE/⏻ to switch to the USB AUDIO mode.

TUNER → XM RADIO/SIRIUS\*<sup>1</sup> → DISC → USB AUDIO\*<sup>2</sup>/  
USB iPod\*<sup>3</sup> → BT AUDIO\*<sup>4</sup>/AUX+\*<sup>5</sup> → CHANGER\*<sup>6</sup> →  
TUNER

\*<sup>1</sup> Only when XM Radio or SIRIUS Radio is connected.

\*<sup>2</sup> Displayed only when no iPhone/iPod is connected.

\*<sup>3</sup> Displayed only when the iPhone/iPod is connected.

\*<sup>4</sup> Displayed only when BLUETOOTH IN is set to ADAPTE, refer to "Setting the Bluetooth Connection" (page 17).

\*<sup>5</sup> Displayed only when the AUX+ SETUP is set to ON, refer to "Setting the AUX+ SETUP Mode" (page 18).

\*<sup>6</sup> Only when the CD changer is connected.

### 2 To pause playback, press ▶/||.

Pressing ▶/|| again will resume the playback.

- The root folder is displayed as "ROOT" in the Folder Name Search mode.
- This unit plays back files in the USB memory with the same controls and modes as playback of CDs containing MP3/WMA/AAC. For details, refer to "CD/MP3/WMA/AAC" on page 9 to 12.
- Before disconnecting USB memory, be sure to change to another source or set to pause.
- The playback time may not be correctly displayed when a VBR (Variable Bit Rate) recorded file is played back.

# iPhone/iPod (Optional)

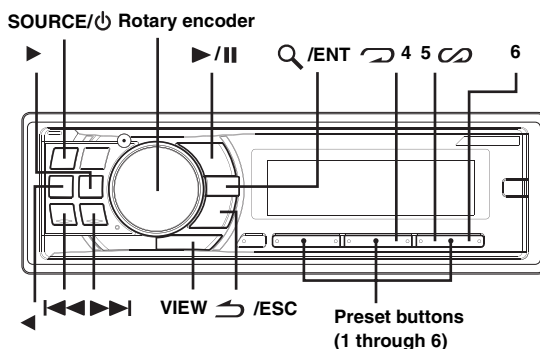

An iPhone/iPod can be connected to this unit by using the Interface cable for iPod (KCU-440i, sold separately). When this unit is connected by using the cable, the controls on the iPod are not functional.

- Internet and telephone functions of iPod touch or iPhone, etc., can also be used when connecting to the unit. However, using these functions will stop or pause the playing songs, at this time do not operate the unit to avoid a malfunction.
- If you connect an iPhone to this unit, it can be used as an iPod. If you use iPhone as a hands-free phone, you need the optional Bluetooth INTERFACE (KCE-400BT).

## iPhones/iPods usable with this unit

- The unit can be used with the fifth generation and above iPod, iPhone 3G, iPhone, iPod touch, iPod classic, the first generation iPod nano, the second generation iPod nano or the third generation iPod nano only. iPod Shuffle cannot be used, however.
- Touch wheel or scroll wheel type iPods without the dock connector cannot be connected to the unit.
- The unit can be used with the following iPhones/iPods.
  - iPhone 3G (version 2.0)
  - iPhone (version 1.1.4)
  - iPod touch (version 1.0.4)
  - iPod classic (version 1.1.1)
  - iPod nano (3rd generation) (version 1.1)
  - iPod nano (2nd generation) (version 1.1.3)
  - iPod with video (version 1.2.3)
  - iPod nano (1st generation) (version 1.3.1)
- For clarity in identifying your model of iPod, please see Apple's own document "Identifying iPod models" at <http://support.apple.com/kb/HT1353>
- This unit does not support iPhone/iPod's video playback function, even using a video-compatible cable.
- If the unit is used with versions of iTunes earlier than 7.6, correct function and performance are not guaranteed.

## Playback

### 1 Press **SOURCE**/**⏻** to switch to the USB iPod mode.

TUNER → XM RADIO/SIRIUS\*<sup>1</sup> → DISC → USB AUDIO\*<sup>2</sup>/  
USB iPod\*<sup>3</sup> → BT AUDIO\*<sup>4</sup>/AUX+\*<sup>5</sup> → CHANGER\*<sup>6</sup> →  
TUNER

\*<sup>1</sup> Only when XM Radio or SIRIUS Radio is connected.

\*<sup>2</sup> Displayed only when no iPhone/iPod is connected.

\*<sup>3</sup> Displayed only when the iPhone/iPod is connected.

\*<sup>4</sup> Displayed only when BLUETOOTH IN is set to ADAPTE, refer to  
“Setting the Bluetooth Connection” (page 17).

\*<sup>5</sup> Displayed only when the AUX+ SETUP is set to ON, refer to “Setting  
the AUX+ SETUP Mode” (page 18).

\*<sup>6</sup> Only when the CD changer is connected.

### 2 Press **⏮** or **⏭** to select the desired song.

**Return to the beginning of the current song:**

Press **⏮**.

**Fast backward through current song:**

Press and hold **⏮**.

**Advance to the beginning of the next song:**

Press **⏭**.

**Fast forward through current song:**

Press and hold **⏭**.

### 3 To pause playback, press **⏸** / **⏹**.

Pressing **⏸** / **⏹** again will resume playback.

- A song playing on the iPhone/iPod while it is connected to this unit will continue to play from where it was paused after disconnection.
- If you listen to an episode from a selected podcast or audiobook, the episode can be changed by pressing **⏮** or **⏭**.
- An episode may have several chapters. The chapter can be changed by pressing **⏮** or **⏭**.

## Searching for a desired Song

An iPhone/iPod can contain hundreds of songs. By using file tag information and keeping these songs organized in playlists, this unit's search functions will ease song searches.

Each music category has its own individual hierarchy. Use the PLAYLIST/ARTIST/ALBUM/SONG/PODCAST/GENRE/COMPOSER/AUDIOBOOK search mode to narrow searches based on the table below.

Hierarchy 1	Hierarchy 2	Hierarchy 3	Hierarchy 4
PLAYLIST	SONG	—	—
ARTIST*	ALBUM*	SONG	—
ALBUM*	SONG	—	—
SONG	—	—	—
PODCAST	EPISODE	—	—
GENRE*	ARTIST*	ALBUM*	SONG
COMPOSER*	ALBUM*	SONG	—
AUDIOBOOK	—	—	—

For example: Searching by Artist name

The following example explains how an ARTIST search is performed. Another search mode can be used for the same operation, although the hierarchy differs.

1 Press **Q** / **ENT** to activate the search selection mode.

2 Turn the **Rotary encoder** to select the Artist search mode, and then press **Q** / **ENT**.

PLAYLIST ↔ ARTIST ↔ ALBUM ↔ SONG ↔  
PODCAST ↔ GENRE ↔ COMPOSER ↔ AUDIOBOOK  
↔ PLAYLIST

3 Turn the **Rotary encoder** to select the desired Artist, and then press **Q** / **ENT**.

4 Turn the **Rotary encoder** to select an album, and then press **Q** / **ENT**.



5 Turn the **Rotary encoder** to select a song and press **Q** / **ENT**.

The selected song is played back.

- After pressing and holding **Q** / **ENT** for at least 2 seconds while in each hierarchy (except SONG and AUDIOBOOK hierarchy), all songs of the selected hierarchy are played back.
- After selecting [ALL] in the search mode with “\*”, press and hold **Q** / **ENT** for at least 2 seconds to play back all songs in the iPhone/iPod or selected search mode.
- While in the search mode, if you press and hold **↵** / **ESC** for at least 2 seconds, or no operation is performed for 30 seconds, the search mode is canceled.
- In the search mode, pressing **↵** / **ESC** will return to the previous mode.
- When search is made during M.I.X. play, the M.I.X. play mode will be canceled.
- “NO SONG” will be displayed if there is no song in the selected playlist in the PLAYLIST search mode.
- “NO PODCAST” will be displayed if there is no podcast data in the iPhone/iPod in the PODCAST search mode.
- “NO AUDIOBOOK” will be displayed if there is no audiobook data in the iPhone/iPod in the AUDIOBOOK search mode.
- If “iPod name” stored in the iPhone/iPod is selected in the desired playlist search mode and **Q** / **ENT** is pressed, you can search for all songs in the iPhone/iPod. Also, if you press and hold **Q** / **ENT** for at least 2 seconds, all songs in the iPhone/iPod are played back.
- Depending on the iPhone/iPod, podcast search is not supported.
- If Alphabet Skip Function is activated in the search mode, a search can be made quickly by Alphabet skip function to find the desired artist or song, etc. For details, refer to “Alphabet Skip Function” on page 25.
- If any one of the **preset buttons (1 through 6)** is pressed in the search mode, a search can be made quickly by skipping to the specified location. For details, refer to “Direct Search Function” on page 25.
- If no operation is performed for 30 seconds during search mode, the unit will return to normal mode.

## Quick Search

You can search a song from all songs in the iPhone/iPod without selecting an album, artist, etc.

- 1 Press and hold  /ENT for at least 2 seconds to activate the Quick Search mode.**
- 2 Turn the Rotary encoder to select a desired song.**  
The selected song is played back immediately.
  - While in the search mode, if you press  /ESC, or no operation is performed for 10 seconds, the search mode is canceled.
  - If many songs are in iPhone/iPod, it takes time to search for songs.
  - If any one of the **preset buttons (1 through 6)** is pressed in the search mode, a search can be made quickly by skipping to the specified location. For details, refer to "Direct Search Function" on page 25.
  - This function is inactive during repeat () playback.

## Direct Search Function

The unit's direct search function can be used to search for an album, song, etc., more efficiently. In Playlist/Artist/Album/Song/Podcast/Genre/Composer/Audiobook mode, you can quickly target any song.

**In the search mode, press any one of the preset buttons (1 through 6) to quickly skip over a designated percent of your song content.**

Song search example:

If there are 100 songs in your iPhone/iPod, they are divided into 6 groups using percentages (shown below). These groups are assigned to preset buttons 1 through 6.

Example 1:

Suppose the song you are searching for is located at around the middle (50%) of your library: press button 4 to jump to the 50th song and turn the **Rotary encoder** to find the desired song.

Example 2:

Suppose the song you are searching for is located near the end (83%) of your library: press button 6 to jump to the 83rd song and turn the **Rotary encoder** to find the desired song.

		All 100 songs (100%)					
		0%	17%	33%	50%	67%	83%
Preset buttons		1	2	3	4	5	6
Songs		First song	17th song	33rd song	50th song	67th song	83rd song

## Select Playlist/Artist/Album/Genre/Composer

Playlist/Artist/Album/Genre/Composer can be easily changed.

For example, if you listen to a song from a selected album, the album can be changed.

**Press  or  select the desired Playlist/Artist/Album/Genre/Composer.**

- If the song search mode was used to select a song, this function is inactive.
- If an album is selected during an artist search, other albums by that artist are searchable.
- This function is inactive during shuffle (M.I.X.) playback.

## Alphabet Skip Function

The initial skip function is skipped to the next number, symbol or letter such as from A to B, B to C.

You can skip in reverse order such as B to A by pressing .

**During search mode, press  or  to perform the Alphabet Skip Function.**

A list is skipped to the next number, symbol or letter.

- If the  or  is pressed and held, the display continuously changes.

---

## Random Play Shuffle (M.I.X.)

---

The Shuffle function of the iPhone/iPod is displayed as  on this unit.

### Shuffle Albums:





The songs on each album are played back in proper order. Upon completion of all the songs on the album, the next album is selected randomly. This continues until all albums have been played.

### Shuffle Songs:

Song shuffle randomly plays back songs within a selected category (playlist, album, etc.). The songs within the category are played just once until all songs have been played.

#### 1 Press 5 .

The songs are played back in random sequence.

  →  → (off) →    
(Shuffle Albums) (Shuffle Songs)

#### 2 To cancel M.I.X. play, select (off) with the above procedure.



- If a song is selected in the album search mode before selecting M.I.X. play, the songs will not play back randomly even when Shuffle Albums is selected.

### Shuffle ALL:

Shuffle ALL plays all songs in the iPhone/iPod randomly. Any one song does not play back again until all songs have been played back.

#### 1 Press 6.

The songs are played back in random sequence.

 → (off) →   
(Shuffle ALL)

#### 2 To cancel M.I.X. play, select (off) with the above procedure.

- If Shuffle ALL is selected, the selected songs being played back in the search mode are canceled.

---

## Repeat Play

---



Only Repeat One is available for the iPhone/iPod.

### Repeat One:



A single song is repeatedly played back.

#### 1 Press 4.

The song is played back repeatedly.

 → (off) →   
(Repeat One)

#### 2 To cancel repeat play, select (off) with the above procedure.

- During repeat playback, no other songs are selectable by pressing  or .

---

## Displaying the Text

---

You can display the tag information of a song in the iPhone/iPod.

### Press VIEW.

Each press changes the display.

- When the TEXT SCROLL is set to MANU, press and hold VIEW for at least 2 seconds, the current text will be scrolled one time.

TRACK NO./ELAPSED TIME → TRACK NO./CLOCK →  
ARTIST NAME\* → ALBUM NAME\* → SONG NAME\* →  
TRACK NO./ELAPSED TIME

#### \* TAG information

“ARTIST”/“ALBUM”/“SONG” is displayed if there is no tag information.

- Only alphanumeric characters (ASCII) can be displayed.
- If the artist, album or song name, created in iTunes, has too many characters, songs may not be played back when connected to the adapter. Therefore, a maximum of 70 characters is recommended. The maximum number of characters for the head unit is 70 (70 byte).
- Some characters may not be correctly displayed.
- “NO SUPPORT” is displayed if text information is not supported by the unit.

# IMPRINT Operation (Optional)

Alpine introduces IMPRINT - the world's first technology that thoroughly eliminates in-car acoustic problems that normally degrade sound quality, which enables us to experience music the way the artist intended, refer to "About IMPRINT" (page 34).

When the IMPRINT audio processor (PXA-H100) (sold separately) is connected to this unit, MultEQ and the following sound adjustment can be performed.

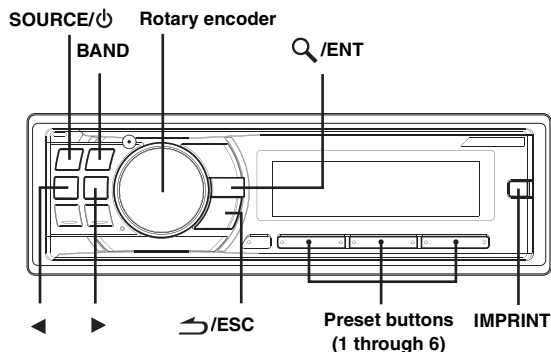

## Changing MultEQ mode

MultEQ, developed by Audyssey Labs, automatically corrects the audio for the listening environment. The system is optimized for selected positions in the vehicle. To accomplish this, MultEQ must take measurements of the vehicles response characteristics. For details on the set up procedure, consult your authorized Alpine dealer.

**Press and hold IMPRINT for at least 2 seconds to change MultEQ mode.**

MULTEQ OFF (Manual Mode) → CURVE 1 (MultEQ-1) →  
CURVE 2 (MultEQ-2) → MULTEQ OFF (Manual Mode)

- The Curve mode can be selected only when curve 1 and curve 2 are stored.
- When using MultEQ, MEDIAXPANDER, MX LEV MODE, CROSSOVER, T.CORR PARA, FACTORY'S EQ, SUBW PHASE, SUBW CHANNEL, TW SETUP, EQ MODE, FILTER TYPE and PARAMETER EQ/GRAPHIC EQ are set automatically. They are no longer user adjustable.
- When an external audio processor is connected, the MultEQ function cannot be used.

## Adjusting Subwoofer Level/Bass Level/ Treble Level/Fader (Between Front and Rear)/Balance (Between Left and Right) in MultEQ mode

You can change these settings to create your own preference in MultEQ (CURVE 1 or CURVE 2) mode.

- 1 Press **IMPRINT** to activate the MultEQ adjustment mode.
- 2 Turn the **Rotary encoder** to select the desired item, and then press **Q/ENT**.

SUBW LEVEL\*1 ↔ BASS LEVEL ↔ TREBLE LEVEL ↔  
FADER\*2 ↔ BALANCE ↔ SUBW LEVEL

- 3 Turn the **Rotary encoder** to change the setting as below, and then press **Q/ENT**.

Subwoofer level: 0 ~ +15  
Bass level: -7 ~ +7  
Treble level: -7 ~ +7  
Fader: R15 ~ F15  
Balance: L15 ~ R15

- If no operation is performed for 60 seconds after selecting the SUBW LEVEL, BASS LEVEL, TREBLE LEVEL, FADER or BALANCE mode the unit automatically returns to normal mode.

\*1 When the SUBWOOFER mode is set to OFF, its level cannot be adjusted, and the SUBWOOFER ON/OFF cannot be adjusted in MultEQ (CURVE 1 or CURVE 2) mode.

\*2 If you set the 2.2ch (3WAY)/4.2ch (FRONT/REAR/SUBW.) switch of the IMPRINT audio processor (PXA-H100) to 2.2ch (3WAY), you cannot adjust the FADER mode. For details, refer to the Owner's Manual of PXA-H100.

- Depending on the connected devices, some functions and display indications do not work.

## Adjusting Sound Setting in Manual Mode

You can change these sound settings to create your own preference when the MultEQ mode is set to MULTEQ OFF (Manual Mode).

**Use steps 1 to 4 to select one of the Sound menu modes to modify. See the applicable section below for details about the selected item.**

- 1 Press IMPRINT to activate the Sound menu selection mode.**
- 2 Turn the Rotary encoder to select the desired item, and then press Q/ENT.**

SUBWOOFER ↔ SUBW SYSTEM\*<sup>1</sup> ↔ SUBW PHASE\*<sup>1</sup> ↔ SUBW CHANNEL \*<sup>1</sup> ↔ FACTORY'S EQ ↔ TW SETUP\*<sup>2</sup> ↔ FILTER TYPE ↔ MEDIAXPANDER ↔ MX LEV MODE\*<sup>3</sup> ↔ EQ MODE ↔ T.CORR PARA ↔ SOUND ADJUST\*<sup>4</sup> ↔ SUBWOOFER  
(e.g. Select SUBWOOFER)

- \*<sup>1</sup> These functions are inoperable when SUBWOOFER is set to OFF.  
\*<sup>2</sup> This function can be operable only when PXA-H100 (sold separately) is connected and 2.2ch (3WAY) mode is set. For details, refer to the Owner's Manual of PXA-H100.  
\*<sup>3</sup> This function is inoperable when MEDIAXPANDER is set to OFF.  
\*<sup>4</sup> In step 2, three sound adjustment items (PARAMETER EQ/ GRAPHIC EQ, T.CORRECTION, CROSSEVER) can be selected in SOUND ADJUST mode, turn the Rotary encoder to select the desired item, and then press Q/ENT to continue to step 3.

- 3 Turn the Rotary encoder to change the setting, and then press Q/ENT.**

(e.g. Select SUBW ON or SUBW OFF)

- 4 Press and hold ↵/ESC for at least 2 seconds to return to normal mode.**

- MEDIAXPANDER FACTORY'S EQ, PARAMETER EQ/GRAPHIC EQ, EQ MODE and MX LEV MODE Adjustment are inoperable when DEFEAT is set to ON.
- Pressing ↵/ESC returns to the previous Sound menu mode.
- If no operation is performed for 60 seconds, Sound menu mode is canceled.

### Turning Subwoofer ON/OFF

When the subwoofer is on, you can adjust the subwoofer output level (refer to page 13).

SUBW OFF ↔ SUBW ON (Initial setting)

### Setting the Subwoofer System

When the subwoofer is on, you can select either System1 or System2 for the desired subwoofer effect.

SUBW SYS 1 (Initial setting) ↔ SUBW SYS 2

SUBW SYS 1 : Subwoofer level changes according to the main volume setting.

SUBW SYS 2 : Subwoofer level change is different from the main volume setting. For example, even at low volume settings, the subwoofer is still audible.

### Setting the Subwoofer Phase

NORMAL (Initial setting) ↔ REVERSE

The subwoofer output phase is toggled SUBWOOFER NORMAL (0°) or SUBWOOFER REVERSE (180°). To adjust the level, turn the Rotary encoder.

### Setting the Subwoofer Channel (SUBW CHANNEL)

You can set the subwoofer output to stereo or monaural. Make sure to set the correct output for your subwoofer type.

STEREO (Initial setting) ↔ MONO

STEREO: Subwoofer stereo (L/R) output

MONO: Subwoofer monaural output

### Equalizer Presets (FACTORY'S EQ)

10 typical equalizer settings are preset at the factory for a variety of musical source material.

FLAT ↔ POPS ↔ ROCK ↔ NEWS ↔ JAZZ&BLUES ↔ ELEC DANCE ↔ HIP HOP&RAP ↔ EASY LISTEN ↔ COUNTRY ↔ CLASSICAL ↔ USER 1 ↔ USER 2 ↔ USER 3 ↔ USER 4 ↔ USER 5 ↔ USER 6

- By selecting USER 1 to 6, you can recall the stored preset number in "Adjusting the Graphic Equalizer Curve" (page 30) or "Adjusting the Parametric Equalizer Curve" (page 29).

### Setting the Response Slope for the High Range Speaker (TW SETUP)

"Setting the response characteristic of tweeter to FLAT in 2.2ch (3WAY) mode could damage the speaker. Make sure the Crossover cut-off is appropriate for the tweeter being used (see "Adjusting the Crossover Settings" on page 30)."

MAKER'S (Initial setting) ↔ USER'S

MAKER'S: As protection from possible speaker damage, FLAT cannot be set for the response slope of the high range speaker in 2.2ch (3WAY) mode.

USER'S: The FLAT setting is possible in 2.2ch (3WAY) mode.

## Setting the Filter type

NORMAL (Initial setting) ↔ INDIVIDUAL

**NORMAL (L=R):** Left and right speakers are adjusted equally.

**INDIVIDUAL (L/R):** Left and right speakers are individually adjusted.

## Turning Media Xpander ON/OFF

When the Media Xpander is on, you can adjust the Media Xpander level (refer to page 29).

MX OFF (Initial setting) ↔ MX ON

## Setting the MX Level

MX (MEDIAXPANDER) makes vocals or instruments sound distinct regardless of the music source. The FM radio, CD, USB memory and iPhone/iPod, will be able to reproduce the music clearly even in cars with a lot of road noise.

### Changing the source to which you want to apply Media Xpander.

#### FM (MX level 1 to 3):

The medium to high frequencies become clearer, and produces well balanced sound at all frequencies.

#### CD (MX level 1 to 3):

CD mode processes a large amount of data during playback. MX takes advantage of this large data quantity to reproduce a more clear, clean output.

#### CMPM/SAT (MX level 1 to 3):

This corrects information that was lost at the time of compression. This reproduces a well-balanced sound close to the original.

#### DVD (Video CD)

##### (MOVIE MX level 1 to 2):

The dialogue portion of a video is reproduced more clearly.

##### (DVD MUSIC):

A DVD or Video CD contains a large quantity of data such as music clip. MX uses this data to reproduce the sound accurately.

#### AUX (MX level 1):

Choose the MX mode (CMPM, MOVIE, or MUSIC) that corresponds to the media connected.

- Each music source, such as FM radio, CD, and MP3/WMA/AAC can have its own MX setting.
- On disks with both MP3/WMA/AAC and CD-DA, when the source changes from "MP3/WMA/AAC to CD-DA" or "CD-DA to MP3/WMA/AAC", MX-mode switching may delay playback slightly.
- Setting to EFFECT OFF sets MX mode of each music source to OFF.
- The function is inoperable when DEFEAT is set to ON.
- There is no MX mode for AM radio.
- If an audio processor with the MX function (PXA-H701, etc.) is connected, its own MX processing is applied to the music source. Since the processor MX settings may not match the head unit, the audio processor needs to be adjusted. For details, refer to the Owner's Manual of the audio processor.
- "CMPM" is applied for MP3/WMA/AAC and iPhone/iPod.
- "SAT" is applied for XM radio and SIRIUS radio.

## Setting EQ mode

This setting gives you a choice of 5-band parametric, or 7-band graphic equalizer.

PARAMETER EQ (Initial setting) ↔ GRAPHIC EQ

PEQ: 5-band Parametric EQ

GEQ: 7-band Graphic EQ

## Setting the Time Correction Unit (T.CORR PARA)

You can change the unit, (cm or inch) of time correction.

CM (Initial setting) ↔ INCH

## Sound Field Adjustment (SOUND ADJUST)

The setting of PARAMETER EQ/GRAPHIC EQ, T.CORRECTION and CROSSOVER can be adjusted in this mode.

### Adjusting the Parametric Equalizer Curve

You can modify the Equalizer settings to create a response curve more appealing to your personal taste. To adjust the Parametric Equalizer Curve, set the EQ MODE to PARAMETER EQ. For details, refer to "Setting EQ mode" (page 29).

#### 1 After selecting PARAMETER EQ from the SOUND ADJUST mode, press **BAND** to select the band to be adjusted.

B 1 → B 2 → B 3 → B 4 → B 5 → B 1

#### 2 Press **◀** or **▶** to select frequency bands.

Adjustable frequency bands:  
20 Hz to 20 kHz (in 1/3 octave steps)

Band-1: 20 Hz~80 Hz (63 Hz)  
Band-2: 50 Hz~200 Hz (150 Hz)  
Band-3: 125 Hz~3.2 kHz (400 Hz)  
Band-4: 315 Hz~8 kHz (1 kHz)  
Band-5: 800 Hz~20 kHz (2.5 kHz)

#### 3 Turn the **Rotary encoder** to adjust the level.

Adjustable level: -6 to +6 dB

#### 4 Press **SOURCE/⏻** to set the bandwidth (Q).

Adjustable bandwidth: 1, 1.5, 3

#### 5 To adjust another band, repeat steps 1 to 4 and adjust all bands.

- The frequencies of adjacent bands cannot be adjusted within 4 steps.
- While adjusting the PARAMETER EQ, you should consider the frequency response of the connected speakers.

## Adjusting the Graphic Equalizer Curve

You can modify the equalizer settings to create a response curve more appealing to your personal taste. To adjust the graphic equalizer curve, set the EQ MODE to GRAPHIC EQ. For details, refer to “Setting EQ mode” (page 29).

- 1 After selecting **GRAPHIC EQ** from the **SOUND ADJUST** mode, press **BAND** to select the band to be adjusted.

B 1 → B 2 → B 3 → B 4 → B 5 → B 6 → B 7 → B 1

Band-1 (63 Hz) / Band-2 (150 Hz) / Band-3 (400 Hz) /  
Band-4 (1 kHz) / Band-5 (2.5 kHz) / Band-6 (6.3 kHz) /  
Band-7 (17.5 kHz)

- 2 Turn the **Rotary encoder** to adjust the level.

Adjustable output level: -6 to +6 dB

- 3 To adjust another band, repeat steps 1 and 2, and then adjust all bands.

## Adjusting the Time Correction

Before performing the following procedures, refer to “About Time Correction” (page 32).

- 1 After selecting **T.CORRECTION** from the **SOUND ADJUST** mode, press **BAND** to select a speaker to be adjusted.

### 2.2ch (3WAY) System

F-L (Initial setting) → F-R → R-L → R-R →  
(Mid-L) (Mid-R) (High-L) (High-R)  
SW-L → SW-R → F-L  
(Mid-L)

### 4.2ch (FRONT/REAR/SUBW.) System

F-L (Initial setting) → F-R → R-L → R-R →  
(Front-L) (Front-R) (Rear-L) (Rear-R)  
SW-L → SW-R → F-L  
(Front-L)

- 2 Turn the **Rotary encoder** to adjust the distance correction value. (0.0 to 336.6cm).

$L = (\text{distance to farthest speaker}) - (\text{distance to other speakers})$

Refer to “Time Correction Value List” on page 32.

- 3 Repeat steps 1 and 2 to set another speaker.

By setting these values to make its sound reach the listening position at the same time as the sound of other speakers.

## Adjusting the Crossover Settings

Before performing the following procedures, refer to “About the Crossover” (page 33).

### 2.2ch (3WAY) System

- 1 After selecting **CROSSOVER** from the **SOUND ADJUST** mode, press **BAND** to select the band to be adjusted.

### 2.2ch (3WAY) System / NORMAL (L=R)

Setting items:

LOW / M-L / M-H / HIGH

### 2.2ch (3WAY) System / INDIVIDUAL (L/R)

Setting items:

L-L / L-R / ML-L / ML-R / MH-L / MH-R / H-L / H-R

- 2 Press **◀** or **▶** to select the desired cut-off frequency (Crossover Point).

Adjustable frequency bands:

### 2.2ch (3WAY) System

Setting items:

LOW / M-L 20 Hz~200 Hz  
M-H 20 Hz~20 kHz  
HIGH (1 kHz~20 kHz)<sup>\*1</sup> / (20 Hz~20 kHz)<sup>\*2</sup>

<sup>\*1</sup> When **MAKER'S** is selected, refer to “Setting the Response Slope for the High Range Speaker (TW SETUP)” (page 28).

<sup>\*2</sup> When **USER'S** is selected, refer to “Setting the Response Slope for the High Range Speaker (TW SETUP)” (page 28).

- 3 Press **SOURCE/⏻** to adjust the slope.

Adjustable slope: FLAT\*, 6 dB/oct., 12 dB/oct., 18 dB/oct., 24 dB/oct.

\* FLAT can be set for the HIGH slope only when **USER'S** is selected in “Setting the Response Slope for the High Range Speaker (TW SETUP)” (page 28). Depending on the response characteristics of the speaker, care should be taken when setting the response slope to FLAT, as speaker damage may result. With this unit, a message is displayed when the response slope for the high range speaker is set to FLAT.

- 4 Turn the **Rotary encoder** to adjust the output level.

Adjustable output level: -12 to 0 dB.

- 5 Repeat steps 1 to 4 to make adjustment to the other bands.



#### 4.2ch (FRONT/REAR/SUBW.) System

- 1 After selecting **CROSSOVER** from the **SOUND ADJUST** mode, press **BAND** to select the band to be adjusted.

#### 4.2ch (FRONT/REAR/SUBW.) System / NORMAL (L=R)

**setting items:**

LOW (SUB-W) / MID (REAR) / HIGH (FRONT)

#### 4.2ch (FRONT/REAR/SUBW.) System / INDIVIDUAL (L/R)

**setting items:**

L (SUB-W)-L / L (SUB-W)-R / M (REAR)-L /  
M (REAR)-R / H (FRONT)-L / H (FRONT)-R

- 2 Press **◀** or **▶** to select the desired cut-off frequency (**Crossover Point**).

Adjustable frequency bands:

#### 4.2ch (FRONT/REAR/SUBW.) System

**Setting items:**

20 Hz~200 Hz

- 3 Press **SOURCE**/**⏻** to adjust the slope.

Adjustable slope: FLAT, 6 dB/oct., 12 dB/oct., 18 dB/oct.,  
24 dB/oct.

- 4 Turn the **Rotary encoder** to adjust the output level.

Adjustable output level: -12 to 0 dB.

- 5 Repeat steps 1 to 4 to make adjustment to the other bands.

- While adjusting the **CROSSOVER**, you should consider the frequency response of the connected speakers.
- About the 2.2ch (3WAY)/4.2ch (FRONT/REAR/SUBW.) system  
You can switch to 2.2ch (3WAY)/4.2ch (FRONT/REAR/SUBW.) system mode with the 2.2ch (3WAY)/4.2ch (FRONT/REAR/SUBW.) switch on the PXA-H100. For details, refer to the Owner's Manual of PXA-H100.

#### Storing the Sound Field Adjustment Settings

The SOUND ADJUST Settings containing PARAMETER EQ/ GRAPHIC EQ, T.CORRECTION and CROSSOVER settings can be stored in the preset memory.

- 1 When the settings of SOUND ADJUST have been completed, select any one of the **preset buttons (1 through 6)** in any item of the SOUND ADJUST mode (e.g. **CROSSOVER**), press and hold the desired preset buttons for at least 2 seconds.

- 2 Turn the **Rotary encoder** to select **PROTECT YES/NO**, and then press **Q/ENT** to store the adjusted contents.

PROTECT YES (Initial setting) ↔ PROTECT NO

- If YES is selected, the adjusted contents are protected and stored into the preset buttons. When you want to store the parameter into a protected preset button, "REPLACE NO/YES" can be selected.
- If NO is selected, the preset is stored.
- While perform this operation, all adjusted contents of PARAMETER EQ/GRAPHIC EQ, T.CORRECTION and CROSSOVER will be stored in the preset buttons.
- The stored contents are not deleted even when resetting the unit or disconnecting the battery.
- The stored contents can be recalled by performing operation in "Recalling the Stored Sound Field Adjustment Settings" (page 31).

#### Recalling the Stored Sound Field Adjustment Settings

The stored SOUND ADJUST Settings contain PARAMETER EQ/ GRAPHIC EQ, T.CORRECTION and CROSSOVER settings that are stored in the preset memory.

- 1 After selecting any item of the SOUND ADJUST mode (e.g. **CROSSOVER**), press any one of the **preset buttons (1 through 6)** that has your desired characteristic in memory to recall the stored settings.

- 2 Press the **preset buttons** again to return to the SOUND ADJUST mode.

- While performing this operation, all adjustment contents of PARAMETER EQ/GRAPHIC EQ, T.CORRECTION and CROSSOVER stored in the preset buttons will be recalled.

## About Time Correction

The distance between the listener and the speakers in a car vary widely due to the complex speaker placement. This difference in the distances from the speakers to the listener creates a shift in the sounds image and frequency characteristics. This is caused by the time delay between the sound reaching the listener's right versus the left ear. To correct this, this unit is able to delay the audio signal to the speakers closest to the listener. This effectively creates a perception of increased distance for those speakers. The listener can be placed at an equal distance between the left and right speakers for optimum staging. The adjustment will be made for each speaker in 3.4cm steps.

### Example 1. Listening Position: Front Left Seat

Adjust the time correction level of the front left speaker to a high value and the rear right to zero or a low value.

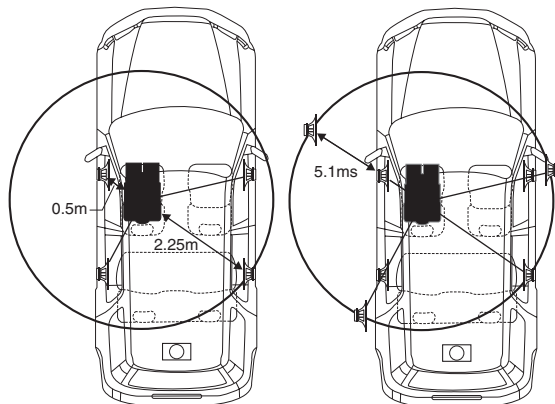

The sound is not balanced because the distance between the listening position and the various speakers is different. The difference in distance between the front left speaker and the rear right speaker is 1.75 m (68-7/8"). Here we calculate the time correction value for the front left speaker in the diagram on the above.

Conditions:

Farthest Speaker – listening position : 2.25 m (88-9/16")

Front left speaker – listening position : 0.5 m (19-11/16")

Calculation:  $L = 2.25\text{ m} - 0.5\text{ m} = 1.75\text{ m}$  (68-7/8")

Time correction =  $1.75 \div 343^{*1} \times 1000 = 5.1$  (ms)

*\*1 Speed of sound: 343 m/s (765 mph) at 20°C*

In other words, giving the front left speaker a time correction value of 5.1 ms makes it seem as if its distance from the listener is the same as the distance to the farthest speaker.

Time correction eliminates the differences in the time required for the sound to reach the listening position.

The time of the front left speaker is corrected by 5.1 ms so that its sound reaches the listening position at the same time as the sound of other speakers.

### Example 2. Listening Position: All Seats

Adjust the time correction level of each speaker to almost the same level.

- 1** Sit in the listening position (driver's seat, etc.) and measure the distance (in meters) between your head and the various speakers.
- 2** Calculate the difference between the distance correction value to the farthest speaker and the other speakers.

$L = (\text{distance to farthest speaker}) - (\text{distance to other speakers})$

These values are the time correction values for the different speakers. Setting these values to make each sound reach the listening position at the same time as the sound of other speakers.

Time Correction Value List

Delay Number	Time Difference (ms)	Distance (cm)	Distance (inch)	Delay Number	Time Difference (ms)	Distance (cm)	Distance (inch)
0	0.0	0.0	0.0	51	5.1	173.4	68.3
1	0.1	3.4	1.3	52	5.2	176.8	69.7
2	0.2	6.8	2.7	53	5.3	180.2	71.0
3	0.3	10.2	4.0	54	5.4	183.6	72.4
4	0.4	13.6	5.4	55	5.5	187.0	73.7
5	0.5	17.0	6.7	56	5.6	190.4	75.0
6	0.6	20.4	8.0	57	5.7	193.8	76.4
7	0.7	23.8	9.4	58	5.8	197.2	77.7
8	0.8	27.2	10.7	59	5.9	200.6	79.1
9	0.9	30.6	12.1	60	6.0	204.0	80.4
10	1.0	34.0	13.4	61	6.1	207.4	81.7
11	1.1	37.4	14.7	62	6.2	210.8	83.1
12	1.2	40.8	16.1	63	6.3	214.2	84.4
13	1.3	44.2	17.4	64	6.4	217.6	85.8
14	1.4	47.6	18.8	65	6.5	221.0	87.1
15	1.5	51.0	20.1	66	6.6	224.4	88.4
16	1.6	54.4	21.4	67	6.7	227.8	89.8
17	1.7	57.8	22.8	68	6.8	231.2	91.1
18	1.8	61.2	24.1	69	6.9	234.6	92.5
19	1.9	64.6	25.5	70	7.0	238.0	93.8
20	2.0	68.0	26.8	71	7.1	241.4	95.1
21	2.1	71.4	28.1	72	7.2	244.8	96.5
22	2.2	74.8	29.5	73	7.3	248.2	97.8
23	2.3	78.2	30.8	74	7.4	251.6	99.2
24	2.4	81.6	32.2	75	7.5	255.0	100.5
25	2.5	85.0	33.5	76	7.6	258.4	101.8
26	2.6	88.4	34.8	77	7.7	261.8	103.2
27	2.7	91.8	36.2	78	7.8	265.2	104.5
28	2.8	95.2	37.5	79	7.9	268.6	105.9
29	2.9	98.6	38.9	80	8.0	272.0	107.2
30	3.0	102.0	40.2	81	8.1	275.4	108.5
31	3.1	105.4	41.5	82	8.2	278.8	109.9
32	3.2	108.8	42.9	83	8.3	282.2	111.2
33	3.3	112.2	44.2	84	8.4	285.6	112.6
34	3.4	115.6	45.6	85	8.5	289.0	113.9
35	3.5	119.0	46.9	86	8.6	292.4	115.2
36	3.6	122.4	48.2	87	8.7	295.8	116.6
37	3.7	125.8	49.6	88	8.8	299.2	117.9
38	3.8	129.2	50.9	89	8.9	302.6	119.3
39	3.9	132.6	52.3	90	9.0	306.0	120.6
40	4.0	136.0	53.6	91	9.1	309.4	121.9
41	4.1	139.4	54.9	92	9.2	312.8	123.3
42	4.2	142.8	56.3	93	9.3	316.2	124.6
43	4.3	146.2	57.6	94	9.4	319.6	126.0
44	4.4	149.6	59.0	95	9.5	323.0	127.3
45	4.5	153.0	60.3	96	9.6	326.4	128.6
46	4.6	156.4	61.6	97	9.7	329.8	130.0
47	4.7	159.8	63.0	98	9.8	333.2	131.3
48	4.8	163.2	64.3	99	9.9	336.6	132.7
49	4.9	166.6	65.7				
50	5.0	170.0	67.0				

# About the Crossover

## Crossover (X-OVER):

This unit is equipped with an active crossover. The crossover limits the frequencies delivered to the outputs. Each channel is controlled independently. Thus, each speaker pair can be driven by the frequencies for which they have been optimally designed.

The crossover adjusts the HPF (high pass filter) or LPF (low pass filter) of each band, and also the slope (how fast the filter rolls off the highs or lows).

Adjustments should be made according to the reproduction characteristics of the speakers. Depending on the speakers, a passive network may not be necessary. If you are unsure about this point, consult your authorized Alpine dealer.

### 4.2ch (FRONT/REAR/SUB.W.) mode

	Cut-off frequency (1/3 octave steps)		Slope		Level
	HPF	LPF	HPF	LPF	
Low range speaker	----	20 Hz - 200 Hz	----	FLAT, 6, 12, 18, 24 dB/oct.	0 to -12 dB
Rear high range speaker	20 Hz - 200 Hz	----	FLAT, 6, 12, 18, 24 dB/oct.	----	0 to -12 dB
Front high range speaker	20 Hz - 200 Hz	----	FLAT, 6, 12, 18, 24 dB/oct.	----	0 to -12 dB

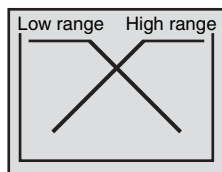

(Different from actual display)

### 2.2ch (3WAY) mode

	Cut-off frequency (1/3 octave steps)		Slope		Level
	HPF	LPF	HPF	LPF	
Low range speaker	----	20 Hz - 200 Hz	----	FLAT, 6, 12, 18, 24 dB/oct.	0 to -12 dB
Mid range speaker	20 Hz - 200 Hz	20 Hz - 20 kHz	FLAT, 6, 12, 18, 24 dB/oct.	FLAT, 6, 12, 18, 24 dB/oct.	0 to -12 dB
High range speaker	1 kHz - 20 kHz, (20 Hz ~ 20 kHz)*	----	FLAT* 6, 12, 18, 24 dB/oct.	----	0 to -12 dB

\* Only when selecting USER'S in "Setting the Response Slope for the High Range Speaker (TW SETUP)" (page 28).

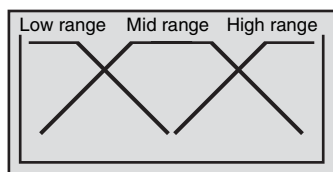

(Different from actual display)

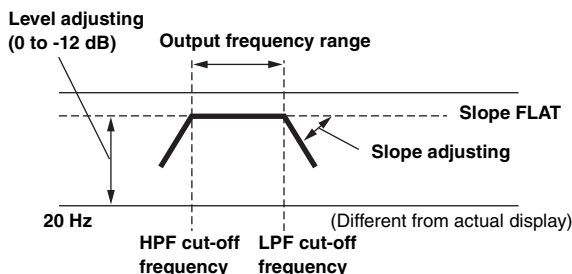

- **HPF (high pass filter):** Cuts the lower frequencies and allows the higher frequencies to pass.
  - **LPF (low pass filter):** Cuts the higher frequencies and allows the lower frequencies to pass.
  - **Slope:** The level change (in dB) for a frequency change of one octave.
  - The higher the slope value, the steeper the slope becomes.
  - Adjust the slope to FLAT to bypass the HP or LP filters.
  - Do not use a tweeter without the HPF on or set to a low frequency, as it may cause damage to the speaker due to the low frequency content.
  - You cannot adjust the crossover frequency higher than the HPF or lower than the LPF.
  - Adjustment should be made according to the recommended crossover frequency of the connected speakers. Determine the recommended crossover frequency of the speakers. Adjusting to a frequency range outside that recommended may cause damage to the speakers. For the recommended crossover frequencies of Alpine speakers, refer to the respective Owner's Manual.
- We are not responsible for damage or malfunction of speakers caused by using the crossover outside the recommended value.

## About IMPRINT

Alpine introduces IMPRINT - the world's first technology that thoroughly eliminates in-car acoustic problems that normally degrade sound quality, which enables us to experience music the way the artist intended.



### VISION VS. REALITY

All good music starts as an artist's vision. After countless hours of rehearsing, recording and mixing, that vision is ready for us to hear on discs, radio and other media. But do we hear it as the artist created it? Unfortunately, the reality is that we are almost never able to listen to it in the exact way the artist intended. Especially when we are listening in a car.

### CARS ARE TERRIBLE LISTENING SPACES

Car interiors are full of materials that obstruct and degrade sound quality. For example, windows amplify and reflect high frequencies. Seat and dashboard coverings change certain frequencies. Carpets absorb and suppress mid frequencies. Graphic and parametric EQs are only partial remedies for these problems. In addition, the speakers are not located at equal distances from listeners, creating an unbalanced, uncentred sound stage. Time correction can help fix this, but only for one listening position.

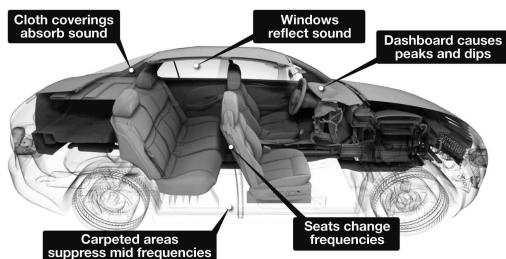

## INTRODUCING IMPRINT

These acoustical problems are so severe that no correction system has been able to overcome them. Until now, with the introduction of IMPRINT, Alpine provides a hardware/software combination that not only solves these problems, it actually improves the sound stage, tonal balance and definition - and does it automatically, in a matter of minutes!

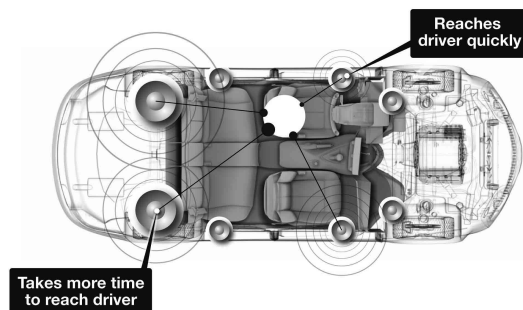

## HOW IMPRINT IS DIFFERENT

IMPRINT using MultEQ is superior to other equalization systems in five ways.

- It is the only system that measures the entire listening area, capturing time domain information from each listening location and applying a proprietary method for processing it to represent all seat locations. This gives the people in each seat the optimal listening experience.
- It corrects both time and frequency problems, for an improved soundstage and smoother, more natural sound.
- It uses dynamic frequency allocation to apply hundreds of points of correction to those areas where the sound problems are greatest.
- It determines optimized blending points for low frequency crossovers.
- It provides, in minutes, vehicle sound tuning that generally takes skilled professionals days to accomplish.

# Changer (Optional)

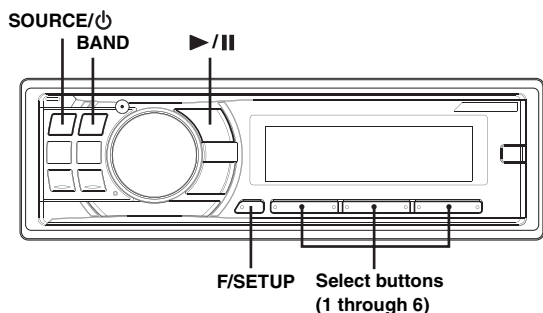

## Controlling CD Changer (Optional)

An optional 6-disc or 12-disc CD Changer may be connected to this unit if it is Ai-NET compatible. With a CD Changer connected to the Ai-NET input of this unit, the CD Changer will be controllable from this unit.

Using the KCA-400C (Multi-Changer Switching device) or the KCA-410C (Versatile Link Terminal) multiple changers can be controlled by this unit.

See "Multi-Changer Selection (Optional)" on page 35 for selecting the CD Changers.

- The controls on this unit for CD Changer operation are operative only when a CD Changer is connected.
- The DVD changer (optional) is controllable from this unit as well as the CD changer.

### 1 Press SOURCE/⏻ to activate the CHANGER mode.

- The source indicator varies depending on the connected source.
- Press BAND to switch the Disc mode in the Changer mode.

### 2 Press F/SETUP to activate Disc Select mode.

Disc Select Mode (Disc No.1~6) → Disc Select Mode \* (Disc No.7~12) →

RPT/M.I.X. Mode → Disc Select Mode (Disc No.1~6)

### 3 Press the disc select buttons (1 through 6) corresponding to one of the discs loaded in the CD Changer.

The selected disc number appears in the display and CD/MP3 playback starts.

- After selecting the desired disc, you can operate in the same way as for the CD player of this unit. For details, see the CD/MP3/WMA/AAC section.

\* When a 12-disc CD changer is connected.

## Playing MP3 Files with the CD Changer (Optional)

If you connect a changer compatible with MP3, you can play CD-ROMs, CD-Rs, and CD-RWs containing MP3 files on this unit.

### 1 Press SOURCE/⏻ to switch to the MP3 Changer mode.

### 2 Press any one of the disc select buttons (1 through 6) corresponding to one of the discs loaded in the CD Changer.

### 3 To pause playback, press ▶/||. Pressing ▶/|| again will resume playback.

- The unit can play discs containing both audio data and MP3 data.
- For operating MP3 with an MP3 compatible CD Changer, refer to "CD/MP3/WMA/AAC" page 9 to 12.

## Multi-Changer Selection (Optional)

Alpine's Ai-NET system will support up to 6 CD Changers. When operating two or more changers, the KCA-400C (Multi-Changer Switching device) must be used. If you use 1 Switching device, you can connect up to 4 CD Changers. If you use 2 Switching devices, you can connect up to 6 CD Changers. When using KCA-410C (Versatile Link Terminal), you can connect two changers and two external outputs (AUX).

### 1 Press SOURCE/⏻ on this unit to activate the CD Changer mode.

Alternatively, press SOURCE on the remote control (RUE-4202) to activate the CD Changer mode.

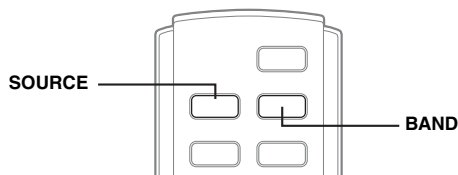

### 2 Press BAND on this unit or the RUE-4202 to activate the CD Changer Selection mode.

The CD Changer Selection mode remains active for a few seconds.

### 3 Press BAND until the desired CD Changer indicator appears on the display.

Alternatively press BAND on the Remote Control until the desired changer indicator appears on the display.

- If the selected CD Changer is not connected, the display will show "NO CHANGER-(No.)".
- To operate the selected changer, see "CD/MP3/WMA/AAC" (pages 9 to 12).
- For further details about the external input (AUX) when using KCA-410C, see "Setting the AUX Mode (V-Link)" on page 18.

# Information

## In Case of Difficulty

If you encounter a problem, turn the power off, then on again. If the unit is still not functioning normally, review the items in the following checklist. This guide will help you isolate the problem if the unit is at fault. Otherwise, make sure the rest of your system is properly connected or consult your authorized Alpine dealer.

### Basic

#### No function or display.

- Vehicle's ignition is off.
  - If connected following instructions, the unit will not operate with the vehicle's ignition off.
- Improper power lead (Red) and battery lead (Yellow) connections.
  - Check power lead and battery lead connections.
- Blown fuse.
  - Check the fuse of the unit; replace with the proper value if necessary.
- Internal micro-computer malfunctioned due to interference noise etc.
  - Press the RESET switch with a ballpoint pen or other pointed article.

### Radio

#### Unable to receive stations.

- No antenna or open connection in cable.
  - Make sure the antenna is properly connected; replace the antenna or cable if necessary.

#### Unable to tune stations in the seek mode.

- You are in a weak signal area.
  - Make sure the tuner is in the DX mode.
- If the area you are in is a primary signal area, the antenna may not be grounded and connected properly.
  - Check your antenna connections; make sure the antenna is properly grounded at its mounting location.
- The antenna may not be the proper length.
  - Make sure the antenna is fully extended; if broken, replace the antenna with a new one.

#### Broadcast is noisy.

- The antenna is not the proper length.
  - Extend the antenna fully; replace it if it is broken.
- The antenna is poorly grounded.
  - Make sure the antenna is grounded properly at its mounting location.

### CD

#### CD Player/Changer not functioning.

- Out of operating temperature range +50°C (+120°F) for CD.
  - Allow the vehicle's interior (or trunk) temperature to cool.

#### CD playback sound is wavering.

- Moisture condensation in the CD Module.
  - Allow enough time for the condensation to evaporate (about 1 hour).

#### CD insertion not possible.

- A CD is already in the CD player.
  - Eject the CD and remove it.
- The CD is being improperly inserted.
  - Make sure the CD is being inserted following instructions in the CD Player Operation section.

#### Unable to fast forward or backward the CD.

- The CD has been damaged.
  - Eject the CD and discard it; using a damaged CD in your unit can cause damage to the mechanism.

#### CD playback sound skips due to vibration.

- Improper mounting of the unit.
  - Securely re-mount the unit.
- The disc is very dirty.
  - Clean the disc.
- The disc has scratches.
  - Change the disc.
- The pick-up lens is dirty.
  - Do not use a commercially available lens cleaner disc. Consult your nearest Alpine dealer.

#### CD playback sound skips without vibration.

- The disc is dirty or scratched.
  - Clean the disc; damaged disc should be replaced.

#### Error displays (built-in CD player only).

- Mechanical error.
  - Press  $\blacktriangle$ . After the error indication disappears, insert the disc again. If the above-mentioned solution does not solve the problem, consult your nearest Alpine dealer.

#### CD-R/CD-RW playback not possible.

- Close session (finalization) has not been performed.
  - Perform finalization and attempt playback again.

### MP3/WMA/AAC

#### MP3, WMA or AAC is not played back.

- Writing error occurred. The CD format is not compatible.
  - Make sure the CD has been written in a supported format. Refer to "About MP3/WMA/AAC" (pages 11-12), then rewrite in the format supported by this device.

### Audio

#### The sound is not output from the speakers.

- Unit has no output signal of the internal amplifier.
  - POWER IC is switched to "ON" (page 17).

### iPod

#### iPod does not play and no sound is output.

- The iPod has not been recognized.
  - Reset this unit and the iPod. Refer to "Initial System Start-Up" (page 6). To reset the iPod, refer to the Owner's Manual of the iPod.

## Indication for CD Player

### NO DISC

- No CD is inserted.
  - Insert a CD.
- Although a disc is inserted, "NO DISC" is displayed and the unit does not start to play or eject the disc.
  - Remove the disc by following these steps:  
Press the **▲** button again for at least 2 seconds.  
If the disc still does not eject, consult your Alpine dealer.

### ERROR

- Mechanism error.
  - 1) Press the **▲** button and eject the CD.  
If not ejecting, consult your Alpine dealer.
  - 2) When the error indication remains after ejecting, press the **▲** button again.  
If the error indication still does not turn off after pressing the **▲** button for a few times, consult your Alpine dealer.
- When "ERROR" is displayed:  
*If the disc cannot be ejected by pressing **▲**, press the RESET switch (refer to page 6) and press **▲** again.  
If the disc still cannot be ejected, consult your Alpine dealer.*

### PROTECT

- A copy-protected WMA file was played back.
  - You can only play back non-copy-protected files.

### UNSUPPORTED

- A sampling rate/bit rate not supported by the unit is used.
  - Use a sampling rate/bit rate that is supported by the unit.

## Indication for CD Changer

### HIGH-TEMP

- Protective circuit is activated due to high temperature.
  - The indication will disappear when the temperature returns to normal operating range.

### ERROR-01

- Malfunction in the CD Changer.
  - Consult your Alpine dealer. Press the magazine eject button and pull out the magazine.  
Check the indication. Insert the magazine again.  
If the magazine cannot be pulled out, consult your Alpine dealer.
- Magazine ejection not possible.
  - Press the magazine eject button. If the magazine does not eject, consult your Alpine dealer.

### ERROR-02

- A disc is left inside the CD Changer.
  - Press the eject button to activate the eject function. When the CD Changer finishes the eject function, insert an empty CD magazine into the CD Changer to receive the disc left inside the CD Changer.

### NO MAGAZINE

- No magazine is loaded into the CD Changer.
  - Insert a magazine.

### NO DISC

- No indicated disc.
  - Choose another disc.

## Indication for SAT Receiver Mode

### CHEK ANTENNA

- The XM or SIRIUS antenna is not connected to the XM or SIRIUS radio module.
  - Check whether the XM or SIRIUS antenna cable is attached securely to the XM or SIRIUS radio module.

### UPDATING

- Radio is being updated with latest encryption code.
  - Wait until encryption code is being updated. Channels 0 and 1 should function normally.

### NO SIGNAL

(XM mode)

### ACQUIRING

(SIRIUS mode)

- XM or SIRIUS signal is too weak at the current location.
  - Wait until the car reaches a location with a stronger signal.

### LOADING

(XM mode)

- Radio is acquiring audio or program information.
  - Wait until the radio has received the information.

### CHAN OFF AIR

(XM mode)

### ACQUIRING

(SIRIUS mode)

- The channel currently selected has stopped broadcasting.
  - Select another channel.

---

## CH UNAVAIL

(XM mode)

- The selected channel is not functional.
  - Change channels.



- The user has selected a channel number that does not exist or is not subscribed to.
  - The unit will revert back to the previously selected channel.
- There is no artist name/feature, song/program title, or additional information associated with the channel at that time.
  - No action needed.

---

## ERROR

- If an error or other problem occurs.
  - Change channels or consult your Alpine dealer.

---

## Indication for USB memory

---

### ERROR

- Communication error
  - Turn the ignition key off, and then set to ON again.

---

### CURRENT ERROR

- Abnormal current is run to the USB connector device.
  - You can solve the problem by switching the source, turning the unit power off, or ACC to the OFF position.

---

### DEVICE ERROR

- A USB device that is not supported by the unit is connected.
  - Connect a USB device that is supported by the unit.

---

### NO USB UNIT

- A USB memory is not connected.
  - Make sure the USB memory device is correctly connected and the cable is not excessively bent.

---

### NO FILE

- No song (file) is stored in the USB memory.
  - Connect the USB memory device after storing songs (files).

---

### UNSUPPORTED

- A sampling rate/bit rate not supported by the unit is used.
  - Use a sampling rate/bit rate that is supported by the unit.

---

### PROTECT

- A copy-protected WMA file was played back.
    - You can only play back non-copy-protected files.
- 

---

## Indication for iPod Mode

---

### NO USB UNIT

- The iPhone/iPod is not connected.
  - Make sure the iPhone/iPod is correctly connected (refer to “Connections” on page 43).  
Make sure the cable is not bent excessively.

---

### NO SONG

- There are no songs in the iPhone/iPod.
  - Download songs to the iPhone/iPod and connect to this unit.

---

### ERROR-01

- Communication error
  - Turn the ignition key off, and then set to ON again.
  - Check the display by reconnecting between the iPhone/iPod and this unit, using the iPod cable.

---

### ERROR-02

- Caused by the iPhone/iPod Software Version not being compatible with this unit.
  - Update the iPhone/iPod Software Version to be compatible with this unit.

---

### ERROR-03

- The iPhone/iPod is not verified.
  - Change another iPhone/iPod.

---

### CURRENT ERROR

- Abnormal current is run to the USB connector device.
  - You can solve the problem by switching the source, turning the unit power off, or ACC to the OFF position.

---

### DEVICE ERROR

- A USB device that is not supported by the unit is connected.
  - Connect a USB device that is supported by the unit.

---

## Indication for all Modes

---

### DC ERROR

- Malfunction occurred as a result of the speaker cable shorting on the car chassis.
    - Route the cable correctly, and set POWER IC to ON (page 17).  
If the above solution does not work, consult your nearest dealer.
-



## Specifications

### FM TUNER SECTION

Tuning Range	87.7-107.9 MHz
Mono Usable Sensitivity	9.3 dBf (0.8 $\mu$ V/75 ohms)
50 dB Quieting Sensitivity	13.5 dBf (1.3 $\mu$ V/75 ohms)
Alternate Channel Selectivity	80 dB
Signal-to-Noise Ratio	65 dB
Stereo Separation	35 dB
Capture Ratio	2.0 dB

### AM TUNER SECTION

Tuning Range	530-1,710 kHz
Sensitivity (IEC Standard)	22.5 $\mu$ V/27 dB

### CD PLAYER SECTION

Frequency Response	5-20,000 Hz ( $\pm$ 1 dB)
Wow & Flutter (% WRMS)	Below measurable limits
Total Harmonic Distortion	0.008% (at 1 kHz)
Dynamic Range	95 dB (at 1 kHz)
Signal-to-Noise Ratio	105 dB
Channel Separation	85 dB (at 1 kHz)

### USB SECTION

USB requirements	USB 1.1/2.0
Max. Power Consumption	500 mA
USB Class	Mass Storage
File System	FAT 12/16/32
MP3 Decoding	MPEG-1/2 AUDIO Layer-3
WMA Decoding	Windows Media™ Audio
AAC Decoding	AAC-LC format “.m4a” file
Number of Channels	2-Channel (Stereo)
Frequency Response*	5-20,000 Hz ( $\pm$ 1 dB)
Total Harmonic Distortion	0.008% (at 1 kHz)
Dynamic Range	95 dB (at 1 kHz)
Signal-to-Noise Ratio	105 dB
Channel Separation	85 dB (at 1 kHz)

\* Frequency response may differ depending on the encoder software/bit rate.

### PICKUP

Wave length	795 nm
Laser power	CLASS I

### GENERAL

Power Requirement	14.4 V DC (11-16 V allowable)
Power Output	18 W RMS $\times$ 4*
*Primary amplifier ratings per CEA-2006 Standard	
• Power output: measured at 4 Ohms and $\leq$ 1% THD+N	
• S/N: 80 dBA (reference: 1 W into 4 Ohms)	
Maximum Pre-Output Voltage	2 V/10 k ohms
Bass	$\pm$ 14 dB at 100 Hz
Treble	$\pm$ 14 dB at 10 kHz
Weight	1.6 kg (3 lbs. 8 oz)

### CHASSIS SIZE

Width	178 mm (7")
Height	50 mm (2")
Depth	160 mm (6-1/4")

### NOSEPIECE SIZE

Width	170 mm (6-3/4")
Height	46 mm (1-13/16")
Depth	24 mm (15/16")

- Due to continuous product improvement, specifications and design are subject to change without notice.

---

---

# Installation and Connections

Before installing or connecting the unit, please read the following and pages 3 to 5 of this manual thoroughly for proper use.

## Warning

---

### MAKE THE CORRECT CONNECTIONS.

Failure to make the proper connections may result in fire or product damage.

---

### USE ONLY IN CARS WITH A 12 VOLT NEGATIVE GROUND.

(Check with your dealer if you are not sure.) Failure to do so may result in fire, etc.

---

### BEFORE WIRING, DISCONNECT THE CABLE FROM THE NEGATIVE BATTERY TERMINAL.

Failure to do so may result in electric shock or injury due to electrical shorts.

---

### DO NOT SPLICE INTO ELECTRICAL CABLES.

Never cut away cable insulation to supply power to other equipment. Doing so will exceed the current carrying capacity of the wire and result in fire or electric shock.

---

### DO NOT DAMAGE PIPE OR WIRING WHEN DRILLING HOLES.

When drilling holes in the chassis for installation, take precautions so as not to contact, damage or obstruct pipes, fuel lines, tanks or electrical wiring. Failure to take such precautions may result in fire.

---

### DO NOT USE BOLTS OR NUTS IN THE BRAKE OR STEERING SYSTEMS TO MAKE GROUND CONNECTIONS.

Bolts or nuts used for the brake or steering systems (or any other safety-related system), or tanks should NEVER be used for installations or ground connections. Using such parts could disable control of the vehicle and cause fire etc.

---

### KEEP SMALL OBJECTS SUCH AS BATTERIES OUT OF THE REACH OF CHILDREN.

Swallowing them may result in serious injury. If swallowed, consult a physician immediately.

---

### DO NOT INSTALL IN LOCATIONS WHICH MIGHT HINDER VEHICLE OPERATION, SUCH AS THE STEERING WHEEL OR GEARSHIFT.

Doing so may obstruct forward vision or hamper movement etc. and results in serious accident.

---

### DO NOT ALLOW CABLES TO BECOME ENTANGLED IN SURROUNDING OBJECTS.

Arrange wiring and cables in compliance with the manual to prevent obstructions when driving. Cables or wiring that obstruct or hang up on places such as the steering wheel, gear lever, brake pedals, etc. can be extremely hazardous.

---

## Caution

---

### HAVE THE WIRING AND INSTALLATION DONE BY EXPERTS.

The wiring and installation of this unit requires special technical skill and experience. To ensure safety, always contact the dealer where you purchased this product to have the work done.

---

### USE SPECIFIED ACCESSORY PARTS AND INSTALL THEM SECURELY.

Be sure to use only the specified accessory parts. Use of other than designated parts may damage this unit internally or may not securely install the unit in place. This may cause parts to become loose resulting in hazards or product failure.

---

### ARRANGE THE WIRING SO IT IS NOT CRIMPED OR PINCHED BY A SHARP METAL EDGE.

Route the cables and wiring away from moving parts (like the seat rails) or sharp or pointed edges. This will prevent crimping and damage to the wiring. If wiring passes through a hole in metal, use a rubber grommet to prevent the wire's insulation from being cut by the metal edge of the hole.

---

### DO NOT INSTALL IN LOCATIONS WITH HIGH MOISTURE OR DUST.

Avoid installing the unit in locations with high incidence of moisture or dust. Moisture or dust that penetrates into this unit may result in product failure.

---

## Precautions

- Be sure to disconnect the cable from the (-) battery post before installing your CDA-105. This will reduce any chance of damage to the unit in case of a short-circuit.
- Be sure to connect the color coded leads according to the diagram. Incorrect connections may cause the unit to malfunction or damage to the vehicle's electrical system.
- When making connections to the vehicle's electrical system, be aware of the factory installed components (e.g. on-board computer). Do not tap into these leads to provide power for this unit. When connecting the CDA-105 to the fuse box, make sure the fuse for the intended circuit of the CDA-105 has the appropriate amperage. Failure to do so may result in damage to the unit and/or the vehicle. When in doubt, consult your Alpine dealer.
- The CDA-105 uses female RCA-type jacks for connection to other units (e.g. amplifier) having RCA connectors. You may need an adaptor to connect other units. If so, please contact your authorized Alpine dealer for assistance.
- Be sure to connect the speaker (-) leads to the speaker (-) terminal. Never connect left and right channel speaker cables to each other or to the vehicle body.

---

#### IMPORTANT

Please record the serial number of your unit in the space provided below and keep it as a permanent record. The serial number or the engraved serial number is located on the bottom of the unit.

SERIAL NUMBER: \_\_\_\_\_

INSTALLATION DATE: \_\_\_\_\_

INSTALLATION TECHNICIAN: \_\_\_\_\_

PLACE OF PURCHASE: \_\_\_\_\_

# Installation

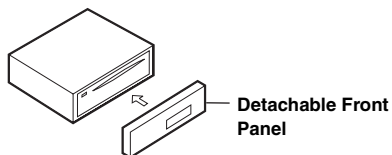

### Caution

When you install this unit in your car, do not remove the detachable front panel. If the detachable front panel is removed during installation, you might press too hard and warp the metal plate that holds it in place.

- The main unit must be mounted within 35 degrees of the horizontal plane, back to front.

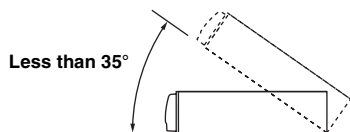

1

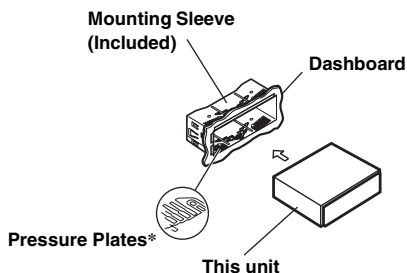

- If the installed mounting sleeve is loose in the dashboard, the pressure plates may be bent slightly to remedy the problem.

Remove the mounting sleeve from the main unit (see "Removal" on page 41).

2

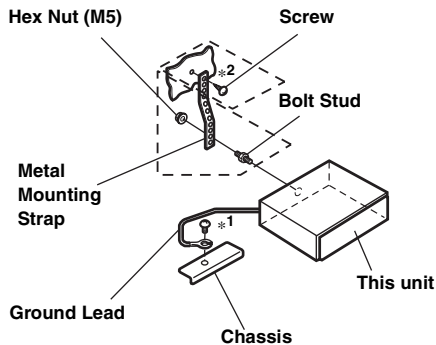

Reinforce the head unit with the metal mounting strap (not supplied). Secure the ground lead of the unit to a clean metal spot using a screw (\*1) already attached to the vehicle's chassis.

- For the screw marked "\*2", use an appropriate screw for the chosen mounting location.

Connect each input lead coming from an amplifier or equalizer to the corresponding output lead coming from the left rear of the CDA-105. Connect all other leads of the CDA-105 according to details described in the CONNECTIONS section.

3

Slide the CDA-105 into the dashboard until it clicks. This ensures that the unit is properly locked and will not accidentally come out from the dashboard.

### Removal

- Remove the detachable front panel.
- Insert the bracket keys into the unit, along the guides on either side. The unit can now be removed from the mounting sleeve.

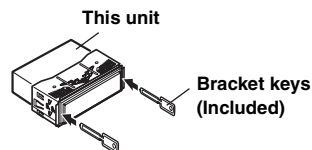

- Pull the unit out, keeping it unlocked as you do so.

### <JAPANESE CAR>

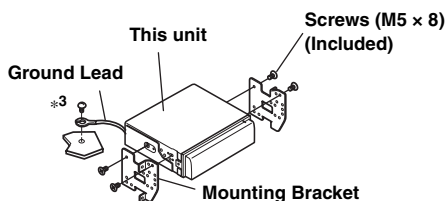
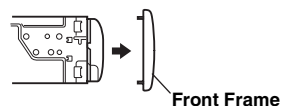

- Secure the ground lead of the unit to a clean metal spot using a screw (\*3) already attached to the vehicle's chassis.

### iPhone/iPod Connection (sold separately)

Connect USB cable to an iPhone/iPod with Interface cable for iPod (KCU-440i, sold separately).

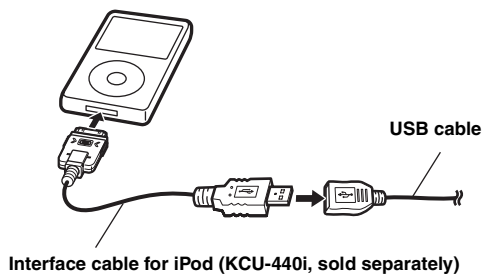

### Remove the iPhone/iPod

Remove the iPhone/iPod from Interface cable for iPod (KCU-440i, sold separately).

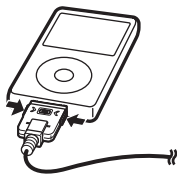

- After changing the unit to a source other than the iPhone/iPod, remove the iPhone/iPod. If the iPhone/iPod is removed in the iPod mode, data may cause damage.
- If sound is not output or the iPhone/iPod is not recognised even when the iPhone/iPod is connected, remove the iPhone/iPod once, then connect it again, or reset the iPod.
- Do not leave the iPhone/iPod in a vehicle for a long time. Heat and humidity may damage the iPhone/iPod and you may not be able to play it again.

### USB memory Connection (sold separately)

#### Connect USB memory

Connect USB memory to USB cable.

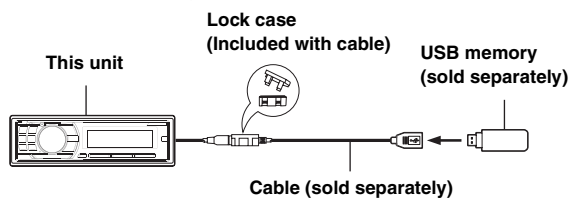

#### Remove USB memory

Pull out USB memory squarely from the USB cable.

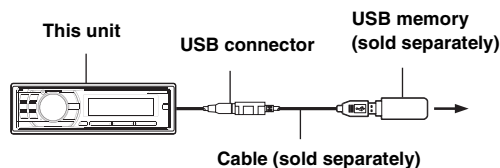

- When removing USB memory, pull it out straight.
- If sound is not output or USB memory is not recognized even when USB memory is connected, remove USB memory once, then connect it again.
- Change to a source other than the USB memory mode, then remove the USB memory. If the USB memory is removed in the USB memory mode, data may be damaged.
- Route the USB cable away from another cables, etc.

# Connections

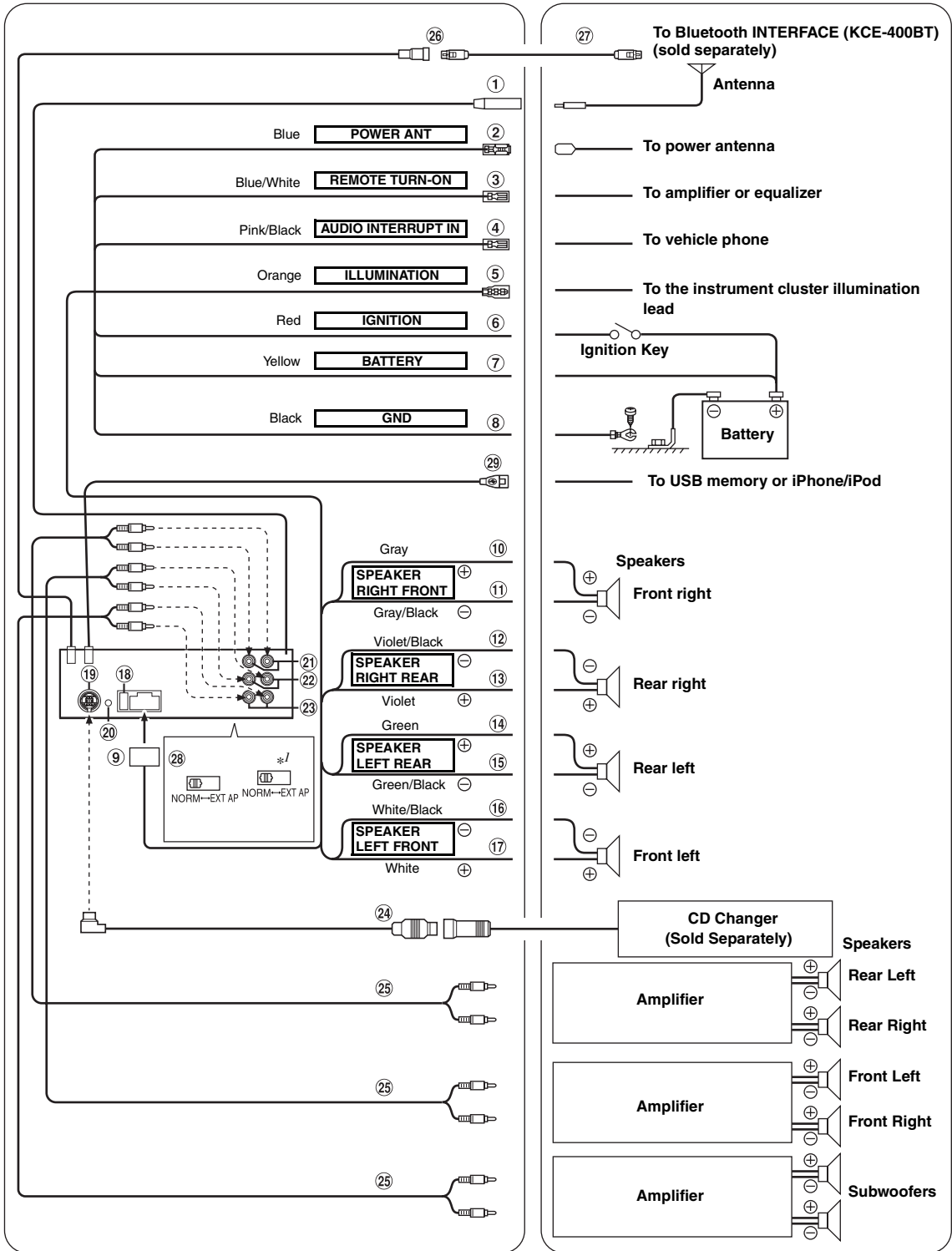

\*<sup>1</sup> The system switch is located on the bottom of the unit.

- ① **Antenna Receptacle**
- ② **Power Antenna Lead (Blue)**  
Connect this lead to the +B terminal of your power antenna, if applicable.
  - *This lead should be used only for controlling the vehicle's power antenna. Do not use this lead to turn on an amplifier, or a signal processor, etc.*
- ③ **Remote Turn-On Lead (Blue/White)**  
Connect this lead to the remote turn-on lead of your amplifier or signal processor. When an IMPRINT audio processor PXA-H100 (sold separately) is connected, use the Remote Turn-on lead of PXA-H100 to connect to your amplifier or signal processor. For details, refer to the Owner's Manual of PXA-H100.
- ④ **Audio Interrupt In Lead (Pink/Black)**  
Connect this lead to the Audio interface output of a cellular phone which provides ground shorting when a call is received.
- ⑤ **Illumination Lead (Orange)**  
This lead may be connected to the vehicle's instrument cluster illumination lead. This will allow the backlighting of the CDA-105 to dim whenever the vehicle's lights are turned on.
- ⑥ **Switched Power Lead (Ignition) (Red)**  
Connect this lead to an open terminal on the vehicle's fuse box or another unused power source which provides (+)12V only when the ignition is turned on or in the accessory position.
- ⑦ **Battery Lead (Yellow)**  
Connect this lead to the positive (+) post of the vehicle's battery.
- ⑧ **Ground Lead (Black)**  
Connect this lead to a good chassis ground on the vehicle. Make sure the connection is made to bare metal and is securely fastened using the sheet metal screw provided.
- ⑨ **Power Supply Connector**
- ⑩ **Right Front (+) Speaker Output Lead (Gray)**
- ⑪ **Right Front (-) Speaker Output Lead (Gray/Black)**
- ⑫ **Right Rear (-) Speaker Output Lead (Violet/Black)**
- ⑬ **Right Rear (+) Speaker Output Lead (Violet)**
- ⑭ **Left Rear (+) Speaker Output Lead (Green)**
- ⑮ **Left Rear (-) Speaker Output Lead (Green/Black)**
- ⑯ **Left Front (-) Speaker Output Lead (White/Black)**
- ⑰ **Left Front (+) Speaker Output Lead (White)**
- ⑱ **Fuse Holder (10A)**
- ⑲ **Ai-NET Connector**  
Connect this to the output or input connector of another device (CD Changer, IMPRINT audio processor, Equalizer, HD Radio TUNER MODULE, etc.) equipped with Ai-NET.
  - *Interface adapter for iPod (KCA-420i) is not recommended for use with this product.*
  - *You can input TV/video sound by connecting an optional Ai-NET/RCA Interface cable (KCA-121B) to this component.*
  - *Be sure to set "Setting the Connected Head Unit (MODEL SETUP)" to "CD CHG", when the DHA-S690 is connected.*
- ⑳ **Steering Remote Control Interface Connector**  
To steering Remote control interface box.
- ㉑ **Rear Output/Input RCA Connectors**  
It can be used as Rear Output or Input RCA Connectors. RED is right and WHITE is left.
- ㉒ **Front Output/Input RCA Connectors**  
It can be used as Front Output or Input RCA Connectors. RED is right and WHITE is left.
- ㉓ **Subwoofer RCA Connectors**  
RED is right and WHITE is left.
- ㉔ **Ai-NET Cable (Included with CD Changer)**
- ㉕ **RCA Extension Cable (sold separately)**
- ㉖ **Bluetooth interface connector**  
Connect this to an optional Bluetooth INTERFACE (KCE-400BT). To use a hands-free mobile phone, an optional Bluetooth INTERFACE (KCE-400BT) connection is required. For details on connection, refer to the Owner's Manual of the Bluetooth INTERFACE (KCE-400BT). You can also connect this to an external device (such as a portable player) by using conversion cable (KCE-237B) for building up the AUX IN (sold separately).
  - \* Refer to "Setting the AUX+ SETUP Mode" (page 18).
    - AUX+ ON : When the external device is connected.
    - AUX+ OFF : When set to OFF, AUX+ source cannot be selected.
- ㉗ **KCE-400BT Connection Cable (Included with KCE-400BT)**
- ㉘ **System Switch**  
When connecting a processor or divider using Ai-NET, place the two switches in the EXT AP position. When no device is connected, leave the switch in the NORM position.
  - *Do not make the two switches to different settings.*
  - *Be sure to turn the power off to the unit before changing the switch position.*
- ㉙ **USB Connector**  
Connect this to a USB memory or to an iPhone/iPod. To use an iPhone/iPod, Interface cable for iPod (KCU-440i, sold separately) connection is required.
  - *Route the USB cable away from other cables.*

#### **To prevent external noise from entering the audio system.**

- Locate the unit and route the leads at least 10 cm away from the car harness.
- Keep the battery power leads as far away from other leads as possible.
- Connect the ground lead securely to a bare metal spot (remove any paint, dirt or grease if necessary) of the car chassis.
- If you add an optional noise suppressor, connect it as far away from the unit as possible. Your Alpine dealer carries various noise suppressors, contact them for further information.
- Your Alpine dealer knows best about noise prevention measures so consult your dealer for further information.



## LIMITED WARRANTY

ALPINE ELECTRONICS OF AMERICA, INC. AND ALPINE OF CANADA INC. ("Alpine"), are dedicated to quality craftsmanship and are pleased to offer this Warranty. We suggest that you read it thoroughly. Should you have any questions, please contact your Dealer or contact Alpine at one of the telephone numbers listed below.

### ● PRODUCTS COVERED:

This Warranty covers Car Audio Products and Related Accessories ("the product"). Products purchased in the Canada are covered only in the Canada. Products purchased in the U.S.A. are covered only in the U.S.A.

### ● LENGTH OF WARRANTY:

This Warranty is in effect for one year from the date of the first consumer purchase.

### ● WHO IS COVERED:

This Warranty only covers the original purchaser of the product, who must reside in the United States, Puerto Rico or Canada.

### ● WHAT IS COVERED:

This Warranty covers defects in materials or workmanship (parts and labor) in the product.

### ● WHAT IS NOT COVERED:

This Warranty does not cover the following:

- ① Damage occurring during shipment of the product to Alpine for repair (claims must be presented to the carrier).
- ② Damage caused by accident or abuse, including burned voice coils caused by over-driving the speaker (amplifier level is turned up and driven into distortion or clipping). Speaker mechanical failure (e.g. punctures, tears or rips). Cracked or damaged LCD panels. Dropped or damaged hard drives.
- ③ Damage caused by negligence, misuse, improper operation or failure to follow instructions contained in the Owner's manual.
- ④ Damage caused by act of God, including without limitation, earthquake, fire, flood, storms or other acts of nature. Any cost or expense related to the removal or reinstallation of the product.
- ⑤ Service performed by an unauthorized person, company or association.
- ⑥ Any product which has the serial number defaced, altered or removed.
- ⑦ Any product which has been adjusted, altered or modified without Alpine's consent.
- ⑧ Any product not distributed by Alpine within the United States, Puerto Rico or Canada.
- ⑨ Any product not purchased from an Authorized Alpine Dealer.

### ● HOW TO OBTAIN WARRANTY SERVICE:

- ① You are responsible for delivery of the product to an Authorized Alpine Service Center or Alpine for repair and for payment of any initial shipping charges. Alpine will, at its option, repair or replace the product with a new or reconditioned product without charge. If the repairs are covered by the warranty, and if the product was shipped to an Authorized Alpine Service Center or Alpine, Alpine will pay the return shipping charges.
- ② You should provide a detailed description of the problem(s) for which service is required.

- ③ You must supply proof of your purchase of the product.
- ④ You must package the product securely to avoid damage during shipment. To prevent lost packages it is recommended to use a carrier that provides a tracking service.

### ● HOW WE LIMIT IMPLIED WARRANTIES:

ANY IMPLIED WARRANTIES INCLUDING FITNESS FOR USE AND MERCHANTABILITY ARE LIMITED IN DURATION TO THE PERIOD OF THE EXPRESS WARRANTY SET FORTH ABOVE AND NO PERSON IS AUTHORIZED TO ASSUME FOR ALPINE ANY OTHER LIABILITY IN CONNECTION WITH THE SALE OF THE PRODUCT.

### ● HOW WE EXCLUDE CERTAIN DAMAGES:

ALPINE EXPRESSLY DISCLAIMS LIABILITY FOR INCIDENTAL AND CONSEQUENTIAL DAMAGES CAUSED BY THE PRODUCT. THE TERM "INCIDENTAL DAMAGES" REFERS TO EXPENSES OF TRANSPORTING THE PRODUCT TO THE ALPINE SERVICE CENTER, LOSS OF THE ORIGINAL PURCHASER'S TIME, LOSS OF THE USE OF THE PRODUCT, BUS FARES, CAR RENTALS OR OTHERS COSTS RELATING TO THE CARE AND CUSTODY OF THE PRODUCT. THE TERM "CONSEQUENTIAL DAMAGES" REFERS TO THE COST OF REPAIRING OR REPLACING OTHER PROPERTY WHICH IS DAMAGED WHEN THIS PRODUCT DOES NOT WORK PROPERLY. THE REMEDIES PROVIDED UNDER THIS WARRANTY ARE EXCLUSIVE AND IN LIEU OF ALL OTHERS.

### ● HOW STATE/PROVINCIAL LAW RELATES TO THE WARRANTY:

This Warranty gives you specific legal rights, and you may also have other rights which vary from state to state and province to province. In addition, some states/provinces do not allow limitations on how long an implied warranty lasts, and some do not allow the exclusion or limitation of incidental or consequential damages. Accordingly, limitations as to these matters contained herein may not apply to you.

### ● IN CANADA ONLY:

This Warranty is not valid unless your Alpine car audio product has been installed in your vehicle by an Authorized Installation Center, and this warranty stamped upon installation by the installation center.

### ● HOW TO CONTACT CUSTOMER SERVICE:

Should the product require service, please call the following number for your nearest Authorized Alpine Service Center.

CAR AUDIO	1-800-ALPINE-1 (1-800-257-4631)
NAVIGATION	1-888-NAV-HELP (1-888-628-4357)

Or visit our website at; <http://www.alpine-usa.com>

ALPINE ELECTRONICS OF AMERICA, INC., 19145 Gramercy Place, Torrance, California 90501, U.S.A.

ALPINE ELECTRONICS OF CANADA, INC., 777 Supertest Road, Toronto, Ontario M3J 2M9, Canada

Do not send products to these addresses.

Call the toll free telephone number or visit the website to locate a service center.