



10-INCH ADVANCED NAVI STATION

X110

8-INCH ADVANCED NAVI STATION

X108U

7-INCH ADVANCED NAVI STATION

INE-W967HD

EN

FR

ES

- OWNER'S MANUAL

Please read before using this equipment.

- MODE D'EMPLOI

Veillez lire avant d'utiliser cet appareil.

- MANUAL DE OPERACIÓN

Léalo antes de utilizar este equipo.

Thank you for purchasing this Alpine product. Please take a moment to protect your purchase by registering your product now at the following address: www.alpine-usa.com/registration. You will be informed of product and software updates (if applicable), special promotions, news about Alpine, and entered for a chance to win prizes.

Merci d'avoir acheté ce produit Alpine. Nous vous invitons à consacrer un moment à la protection de votre achat en enregistrant votre produit dès maintenant à l'adresse suivante : www.alpine-usa.com/registration.

Vous serez tenu informé des mises à jour des produits et des logiciels (le cas échéant), des promotions spéciales, de l'actualité d'Alpine, et vous aurez une chance de remporter des prix.

Gracias por adquirir este producto Alpine. Con solo unos pocos pasos podrá proteger su producto, registrándolo a través de la siguiente dirección: www.alpine-usa.com/registration.

Recibirá información sobre nuevos productos y software, promociones especiales, novedades sobre Alpine y participará en el sorteo de premios.

For X108U/INE-W967HD

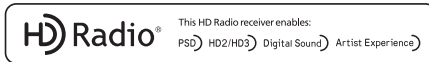

For X110

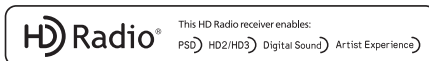

Contents

Operating Instructions

PRECAUTIONS

IMPORTANT INFORMATION 8

WARNING

Points to Observe for Safe Usage 8

WARNING 9

CAUTION 10

NOTICE 10

Features

Favorite Function 12

About Swiping the Touch Screen 12

Switching the Audio Sources Screen to a
Dedicated Screen 13

About Dual Screen 14

Dual Screen Display Position 14

Getting Started

Location of Controls 15

Turning Power On or Off 16

Turning the System On 16

Initial System Start-Up 16

Adjusting the Volume 16

Lowering Volume Quickly 16

Touch Screen Operation 17

Switching Sources 17

Operating the Function Button on the Audio/
Video Main Screen 18

About Basic Operation for List Screen 18

About the Shortcut Setup Screen 19

Sound Setup Function 19

Rear Seat Entertainment Function 20

About the Menu Screen 21

Edit Menu 21

About the Indicator Display 22

Opening screen Customization 22

How to Input Characters and Numbers
(Keypad) 23

Favorite Function

Using the Favorite Function 24

Editing the Favorite Screen 24

Registering Items 24

Changing Item Names 25

Changing Icons (only the Shortcut Dialing and
Navigation icons) 25

Changing the Layout 26

Deleting Items 26

Applying Alpine Tunelt App

Adjusting the sound via the Smartphone 27

Facebook Notification Function 27

Setup

Setup Operation 29

Wireless (Bluetooth) Setup

Bluetooth Setup 30

Displaying Bluetooth Information 30

Registering the Bluetooth Device 30

Hands-free Device Primary/Secondary
Setting 31

iPhone Auto Pairing Setting 31

Device Setup 31

Setting the Passcode 31

Changing the Character Code of the Phone
Book 32

Selecting the Output Speaker 32

Setting the Microphone Select
(X108U/INE-W967HD only) 32

General Setup

Sound Setup 33

Setting the Balance/Fader/Rear Speaker/
Subwoofer 33

Setting the Media Xpander (MX HD) 34

Equalizer Presets 34

Adjusting the Parametric Equalizer Curve
(Dual HD EQ) 34

Adjusting the Crossover Settings
(X-Over) 35

Adjusting the Time Correction (TCR) 36

Setting Defeat 36

Setting the Volume for Each Source 36

Adjusting the Caller Level 36

Adjusting the Microphone Level	36
Adjusting the Ring Tone Level	36
Volume Setting	36
Setting Audio Mute On/Off while Backing up	37
Default Sound Settings	37
About the Crossover	37
About Time Correction	38
Picture Quality Setup	39
Selecting the Visual EQ Mode (Factory's setting)	39
Adjusting Brightness	39
Adjusting Color of Picture	39
Adjusting Tint of Picture	39
Adjusting Image Contrast	39
Adjusting Picture Quality	39
Saving and calling the adjusted picture quality	39
Display/Key Setup	40
Screen/Lighting Customize	40
Switching the Display Color	40
Switching the Illumination Color (X108U/INE-W967HD only)	40
Setting the Text Scroll	40
Switching the Artwork Position	40
General Setup	41
Setting the Menu Language	41
Format settings	41
About X110/X108U/INE-W967HD	41
Setting Demo mode to Off/On	41
Vehicle Setup	41
Installation Setup	41

Source Setup

Radio Setup	42
Setting the TUNER (FM) Tone Quality (Tuner Condition)	42
Setting the TUNER (FM) Frequency Step	42
SiriusXM Setup	42
Setting the Alert individually for an Artist/Song/ Favorite Team	43
Setting ON/OFF of all Songs/Artists/Games Alert	43
Deleting all stored Alert	43
Setting the Favorite Sports Team Alerts	43
Setting the Parental Lock	43
Signal Strength Information	44
AUX Setup (X108U/INE-W967HD only)	44
Setting the AUX Mode	44
Setting the Auxiliary (AUX) Name	45

Switching the Visual Input Signal System	45
HDMI Setup	45
Setting the Bluetooth Pandora®	45

System Setup

Camera Setup	46
Setting the Camera Input	46
Setting the Camera Signal Input	46
Switching Video Patterns for Multi View Camera	46
Adjusting the Rear/Front/Side Camera Guide	46
Camera Interrupt Setting (Power OFF Mode) (Rear Camera Only)	47
Setting Multi Camera to On/Off	48
Factory System Setup	48
Setting the Source Category	48
Setting the Hands-free Connection	48
Setting the Default Vehicle Screen	48
Setting the Maestro Module	48
Rear Seat Entertainment Setup	49
Remote Sensor Setting	49
External Accessories Setup	49
Setting the External Audio Processor	49
Setting the Additional AUX BOX	50
Setting the HDMI Selector On/Off	50
Setting the External Accessory Control	50
Smartphone Apps Setup	50

Radio/HD Radio™/ RBDS

Radio Basic Operation

Listening to the Radio	52
Presetting Stations Manually	52
Presetting Stations Automatically	52
Tuning to Preset Stations	52
Inputting Frequency Directly and Receiving the Radio Station	53
Receiving a Multicast (HD Radio Mode only)	53
Selecting the Receivable Program Type (RBDS FM Radio mode only)	53
Forced Analog Mode	53
Displaying Radio Text (RBDS FM Radio mode only)	53
Using Ballgame Mode	54
About the Feature Logos	54

USB Flash drive (Optional)

Playback	55
Repeat Play	55
Random Play	56
Searching for a Desired Song	56

iPod/iPhone (Optional)

Playback	58
Searching for a Music File	58
Quick Search Mode	58
Full Search Mode	59
Searching for a Desired Video File	59
Alphabet Search Function	59
Repeat Play	60
Random Play (Shuffle)	60
Switching Display Modes (During Video File Play Back)	60

Pandora® internet radio (optional)

Listening to Pandora®	61
“Thumbs” Feedback	62
Searching for a Desired Station	62
QuickMix	62
Creating a New Station	62
Bookmarking a Desired Track or Artist	62
Connecting a Bluetooth Device (Bluetooth Pandora® Only)	63
Disconnecting the Bluetooth Connection	63
Changing the connecting Bluetooth Device	63

SiriusXM Satellite Radio Operation (Optional)

Receiving Channels with the SiriusXM Tuner	65
Tuning Channels by Category	65
Changing the Display	65
Checking the SiriusXM Radio ID Number	65
Storing Channel Presets	65
Tuning Channels using Presets	65
Tune Start Function	66
Tune Scan Function	66
Search Function	66
Selecting the Channel Directly	67
Storing the desired Song/Artist	67

Receiving and Tuning to an Alert	67
Replay Function	67
Parental Lock Function	68
Using Jump Memory and Jump Recall function	68

HDMI Device (X110 only)

About HDMI selector (Optional)	69
--------------------------------------	----

DVD Player Operation

Inserting/Ejecting a Disc	69
Inserting the Disc	69
Removing the Disc	69
DVD Player SETUP	69
System Setup	70
DVD Contents Setup	70
CD Contents Setup	71
Audio Setup	71

CD/MP3/WMA/AAC/WAV

Playback	72
Stopping Playback	72
Repeat Play	72
MIX (Random Play)	73
File/Folder Name Search (Concerning MP3/WMA/AAC/WAV)	73
Selecting Folders (Concerning MP3/WMA/AAC/WAV)	73
Info Mode Function	73

DVD

Playing a Disc	74
If a Menu Screen Appears	75
Numeric Keypad Input Operations	75
Displaying the Top Menu Screen	75
Displaying the Menu Screen	75
Playing Still Frames (Pausing)	75
Stopping Playback	76
Fast-forwarding/Fast-reversing	76
Finding the Beginnings of Chapters/Tracks/ Files	76
Forward/Reverse frame-by-frame Playback ...	76
Repeat Playback	76
Searching by Title Number	77
Searching Directly by Chapter Number	77
Switching the Angle	77
Switching the Audio Tracks	77
Switching the Subtitles (Subtitle Language) ...	77

Info Mode Function	77
Switching Display Modes	77

HDMI Operation

Bluetooth Operation

Setup Before Using	79
About Bluetooth	79
About the Hands-free Phone	79
Before Using Bluetooth	79

Hands-free Phone Control

Answering a Call	80
Hanging up the Telephone	80
Call Waiting Function	80
Calling	81
Calling by Favorite Function	81
Making a phone call using the Phone Menu	81
Using Voice Recognition function	82
Using Siri	82
Voice Dial Function	82
Operations During a Conversation	83
Adjusting the Speech Volume	83
Changing the Voice Output	83
DTMF (Touch-Tone) Function	83
Phone Book Function	83
Synchronizing the Phone Book	83
Adding the Phone Book	83
Deleting the Phone Book Entries	84
Searching in the Phone Book	84

Bluetooth Audio

Playback	85
Repeat Play	85
Random Play	85
Search Function	85
Connecting a Bluetooth Device	86
Disconnecting the Bluetooth Connection ...	86
Changing the connecting Bluetooth Device	86

Auxiliary Device (X108U/INE-W967HD only) (Optional)

Operating Auxiliary Devices (Optional)	87
Operating an AUX, AUX DVD, GAME or USB Player	87
Operating an External DVD Player	87
Operating an External DVD Changer	88

Operating the Mobile Digital TV Receiver (DVB-T)	88
Operating a TV	89

Camera Operation (Optional)

Rear Camera Operation	90
Displaying the Rear Camera Image from the Menu screen	90
Displaying the rear view video while the car is in reverse	90
Switching the Image Pattern for the Rear Camera	90
Guide Display ON/OFF Setting	90
Adjusting the Caution Display Location	91
About the Rear Camera Guide	91
Front Camera Operation	92
Displaying the Front Camera image from the Menu screen.	92
Switching the Image Pattern for the Front Camera	92
About the adjustment of guide display ON/OFF setting and adjustment of Caution display location	93
Side Camera Operation	93
Displaying the Side Camera image from the Menu screen.	93
Switching the Image Pattern for the Side Camera	93

iDataLink Operation

Access to iDataLink Mode	94
About Parking Sensor screen	95
External Accessory Control Operation	96

About Remote Control Operation (X110 only)

When Using the Remote Control	97
Battery Replacement	97
Operating the DVD Player	98

Information

Product Software Update	99
Cautions about Discs (X110 only)	99
Discs Playable on This Unit (X110 only)	100
About the Supported Formats	101
About MP3/WMA/AAC/FLAC	101
About WAV (Disc)	102
About DVDs	103
List of Language Codes	104
In Case of Difficulty	105

If this Message Appears 106
Specifications 109
END USER LICENSE AGREEMENT
(HERE) 111

LIMITED WARRANTY

Operating Instructions

PRECAUTIONS

IMPORTANT INFORMATION

PLEASE READ CAREFULLY BEFORE USING THIS PRODUCT

This product is intended to provide turn by turn instructions to get you to a desired destination. Please make certain that all persons using this navigation system carefully read these precautions and the following instructions fully.

- This product is not a substitute for your personal judgment. Any route suggestions made by this navigation system may never supersede any local traffic regulations or your personal judgment and/or knowledge of safe driving practices. Do not follow route suggestions if the navigation system instructs you to perform an unsafe or illegal maneuver, places you in an unsafe situation, or routes you into an area which you consider unsafe.
- Glance at the screen only when necessary and safe to do so. If prolonged viewing of the screen is necessary, pull over in a safe and legal manner and location.
- Do not input destinations, change settings, or access any functions requiring a prolonged view of the monitor and/or remote control while you are driving. Pull over in a safe and legal manner and location before attempting to access the system.
- Do not use the navigation system to route you to emergency services. Not all locations of emergency services such as police and fire stations, hospitals and clinics are contained in the database. Please use your own judgment and ask for directions in these situations.
- The map database used in the navigation system is the most recent map data available at the time of production. Because of changes in streets and neighborhoods, there may be situations where the navigation system is not able to route you to your desired destination. In these cases, use your own judgment.
- The map database is designed to provide you with route suggestions and does not take into account the relative safety of a suggested route or of factors which may affect the time required to reach your destination. The system does not reflect road closures or construction, road characteristics (i.e. type of road surface, slope or grade, weight or height restrictions, etc.), traffic congestion, weather conditions, or any other factors which may affect the safety or timing of your driving experience. Use your own personal judgment if the navigation system is unable to provide you with an alternate route.
- There may be situations where the navigation system displays the vehicle's location erroneously. Use your own driving judgment in this situation, taking into account current driving conditions. Please be aware that in this situation the navigation system should correct the vehicle's position automatically. However, there may be times where you may have to correct the position yourself. If this is the case, pull over in a safe and legal manner and location before attempting operation.
- Make certain that the volume level of the navigation system is set to a level which still allows you to hear outside traffic and emergency vehicles.

If there is anything in the manual about the operation of the navigation system which you are uncertain about, please contact your local Alpine authorized navigation dealer or Alpine at 1-888-NAV-HELP (1-888-628-4357) before using the navigation system.

FCC COMPLIANCE STATEMENT

This equipment has been tested and found to comply with the limits for a Class B digital device, pursuant to part 15 of the FCC Rules. These limits are designed to provide more reasonable protection against harmful interference in a residential installation, and are more stringent than "outdoor" requirements.

Operation is subjected to the following two conditions: (1) This device may not cause harmful interference, and (2) this device must accept any interference received, including interference that may cause undesired operation.

This equipment generates, uses, and can radiate radio frequency energy and, if not installed and used in accordance with the instructions, may cause harmful interference to radio communications. However, there is no guarantee that interference will not occur in a particular installation. If this equipment does cause harmful interference to radio or television reception, which can be determined by turning the equipment off and on, you are encouraged to try to correct the interference by one of the following measures:

- Reorient or relocate the receiving antenna.
- Increase the separation between the equipment and the receiver.
- Connect the equipment into an outlet on a circuit different from that to which the receiver is connected.
- Consult an experienced radio/TV technician.

WARNING

Points to Observe for Safe Usage

- *Read this manual carefully before using this disc and the system components. They contain instructions on how to use this product in a safe and effective manner. Alpine cannot be responsible for problems resulting from failure to observe the instructions in this manual.*
- *This manual uses various pictorial displays to show you how to use this product safely and to alert you to potential dangers resulting from improper connections and operation. Following are the meanings of these pictorial displays. It is important to fully understand the meanings of these pictorial displays in order to use this manual and the system properly.*
- *This product may be used with software applications. Please follow all usage instructions and warnings when using this product at all times. Do not use this product or any software application in a manner which will hinder safe operation of your vehicle.*
- *This product may be used in conjunction with the Alpine KAC-001 External Accessory Control module, which works with various accessory products manufactured by third parties. Please review and follow all manufacturer's instructions and warnings for all accessory products.*



WARNING

- Operation of the system while driving is dangerous. Users should stop vehicle before operating the software.
- Road conditions and regulations take precedence over information contained on the map display: observe actual traffic restrictions and circumstances while driving.
- This software is designed for use exclusively in the unit. It cannot and may not be used in conjunction with other hardware.



WARNING

This symbol means important instructions. Failure to heed them can result in serious injury or death.

INSTALL THE PRODUCT CORRECTLY SO THAT THE DRIVER CANNOT WATCH TV/VIDEO UNLESS THE VEHICLE IS STOPPED AND THE EMERGENCY BRAKE IS APPLIED.

It is dangerous for the driver to watch TV/Video while driving a vehicle. Installing this product incorrectly enables the driver to watch TV/Video while driving. This may cause a distraction, preventing the driver from looking ahead, thus causing an accident. The driver or other people could be severely injured.

DO NOT WATCH VIDEO WHILE DRIVING.

Watching the video may distract the driver from looking ahead of the vehicle and cause an accident.

DO NOT OPERATE ANY FUNCTION THAT TAKES YOUR ATTENTION AWAY FROM SAFELY DRIVING YOUR VEHICLE.

Any function that requires your prolonged attention should only be performed after coming to a complete stop. Always stop the vehicle in a safe location before performing these functions. Failure to do so may result in an accident.

DO NOT FOLLOW ROUTE SUGGESTIONS IF THE NAVIGATION SYSTEM INSTRUCTS YOU TO PERFORM AN UNSAFE OR ILLEGAL MANEUVER, OR PLACES YOU IN AN UNSAFE SITUATION OR AREA.

This product is not a substitute for your personal judgement. Any route suggestions by this system should never supersede any local traffic regulations or your personal judgement or knowledge of safe driving practice.

KEEP THE VOLUME AT A LEVEL WHERE YOU CAN STILL HEAR OUTSIDE NOISES WHILE DRIVING.

Excessive volume levels that obscure sounds such as emergency vehicle sirens or road warning signals (train crossings, etc.) can be dangerous and may result in an accident. LISTENING AT LOUD VOLUME LEVELS IN A CAR MAY ALSO CAUSE HEARING DAMAGE.

MINIMIZE DISPLAY VIEWING WHILE DRIVING.

Viewing the display may distract the driver from looking ahead of the vehicle and cause an accident.

DO NOT DISASSEMBLE OR ALTER.

Doing so may result in an accident, fire or electric shock.

USE ONLY IN CARS WITH A 12 VOLT NEGATIVE GROUND.

(Check with your dealer if you are not sure.) Failure to do so may result in fire, etc.

KEEP SMALL OBJECTS SUCH AS SCREWS OUT OF THE REACH OF CHILDREN.

Swallowing them may result in serious injury. If swallowed, consult a physician immediately.

USE THE CORRECT AMPERE RATING WHEN REPLACING FUSES.

Failure to do so may result in fire or electric shock.

DO NOT BLOCK VENTS OR RADIATOR PANELS.

Doing so may cause heat to build up inside and may result in fire.

USE THIS PRODUCT FOR MOBILE 12V APPLICATIONS.

Use for other than its designed application may result in fire, electric shock or other injury.

MAKE THE CORRECT CONNECTIONS.

Failure to make the proper connections may result in fire or product damage.

BEFORE WIRING, DISCONNECT THE CABLE FROM THE NEGATIVE BATTERY TERMINAL.

Failure to do so may result in electric shock or injury due to electrical shorts.

DO NOT ALLOW CABLES TO BECOME ENTANGLED IN SURROUNDING OBJECTS.

Arrange wiring and cables in compliance with the manual to prevent obstructions when driving. Cables or wiring that obstruct or hang up on places such as the steering wheel, gear lever, brake pedals, etc. can be extremely hazardous.

DO NOT SPLICE INTO ELECTRICAL CABLES.

Never cut away cable insulation to supply power to other equipment. Doing so will exceed the current carrying capacity of the wire and result in fire or electric shock.

DO NOT DAMAGE PIPE OR WIRING WHEN DRILLING HOLES.

When drilling holes in the chassis for installation, take precautions so as not to contact, damage or obstruct pipes, fuel lines, tanks or electrical wiring. Failure to take such precautions may result in fire.

DO NOT USE BOLTS OR NUTS IN THE BRAKE OR STEERING SYSTEMS TO MAKE GROUND CONNECTIONS.

Bolts or nuts used for the brake or steering systems (or any other safety-related system), or tanks should NEVER be used for installations or ground connections. Using such parts could disable control of the vehicle and cause fire etc.

DO NOT INSTALL IN LOCATIONS WHICH MIGHT HINDER VEHICLE OPERATION, SUCH AS THE STEERING WHEEL OR GEARSHIFT.

Doing so may obstruct forward vision or hamper movement etc. and results in serious accident.



CAUTION

This symbol means important instructions. Failure to heed them can result in injury or material property damage.

HALT USE IMMEDIATELY IF A PROBLEM APPEARS.

Failure to do so may cause personal injury or damage to the product. Return it to your authorized Alpine dealer or the nearest Alpine Service Center for repairing.

HAVE THE WIRING AND INSTALLATION DONE BY EXPERTS.

The wiring and installation of this unit requires special technical skill and experience. To ensure safety, always contact the dealer where you purchased this product to have the work done.

USE SPECIFIED ACCESSORY PARTS AND INSTALL THEM SECURELY.

Be sure to use only the specified accessory parts. Use of other than designated parts may damage this unit internally or may not securely install the unit in place. This may cause parts to become loose resulting in hazards or product failure.

ARRANGE THE WIRING SO IT IS NOT CRIMPED OR PINCHED BY A SHARP METAL EDGE.

Route the cables and wiring away from moving parts (like the seat rails) or sharp or pointed edges. This will prevent crimping and damage to the wiring. If wiring passes through a hole in metal, use a rubber grommet to prevent the wire's insulation from being cut by the metal edge of the hole.

DO NOT INSTALL IN LOCATIONS WITH HIGH MOISTURE OR DUST.

Avoid installing the unit in locations with high incidence of moisture or dust. Moisture or dust that penetrates into this unit may result in product failure.



NOTICE

Product Cleaning

Use a soft dry cloth for periodic cleaning of the product. For more severe stains, please dampen the cloth with water only. Anything else has the chance of dissolving the paint or damaging the plastic.

Temperature

Be sure the temperature inside the vehicle is between +45°C (+113°F) and 0°C (+32°F) before turning your unit on.

Maintenance

If you have problems, do not attempt to repair the unit yourself. Return it to your Alpine dealer or the nearest Alpine Service Station for servicing.

Protecting the USB connector

- Only an iPod/iPhone or USB flash drive can be connected to the USB connector on this unit. Correct performance using other USB products cannot be guaranteed.
- If the USB connector is used, be sure to use only the supplied connector cable with the unit. A USB hub is not supported.

- Depending on the connected USB flash drive, the unit may not function or some functions may not be performed.
- The audio file format that can be played back on the unit is MP3/WMA/AAC/FLAC.
- Artist/song name, etc., can be displayed. Certain, special characters may not be correctly displayed.



CAUTION

Alpine accepts no responsibility for lost data, etc., even if data, etc., is lost while using this product.

On Handling USB Flash drive

- This unit can control a memory storage device that supports the USB Mass Storage Class (MSC) protocol. Playable audio file formats are MP3, WMA, AAC and FLAC.
- USB Flash drive function is not guaranteed. Use USB flash drive according to the terms of agreement. Read the USB flash drive Owner's Manual thoroughly.
- Avoid usage or storage in the following locations:
 - Anywhere in the car exposed to direct sunlight or high temperatures.
 - Anywhere the possibility of high humidity or corrosive substances are present.
- Fix the USB flash drive in a location where driver operation will not be hindered.
- USB Flash drive may not function correctly at high or low temperature.
- Use only certified USB flash drive. Note that even certified USB flash drive, may not function correctly depending on its type or state.
- Depending on the settings of the USB flash drive type, memory state or encoding software, the unit may not play back or display properly.
- USB Flash drive may take time to start playback. If there is a particular file other than audio in the USB flash drive, it may take considerable time before the file is played back or searched.
- The unit can play back "mp3," "wma" or "m4a" file extensions.
- Do not add the above extensions to a file other than audio data. This non-audio data will not be recognized. The resulting playback may contain noise that can damage speakers and/or amplifiers.
- It is recommended to back up important data on a personal computer.
- Do not remove the USB device while playback is in progress. Change SOURCE to something other than USB, then remove the USB device to prevent possible damage to its memory.

Commonness

- *Windows Media, and the Windows logo are trademarks, or registered trademarks of Microsoft Corporation in the United States and/or other countries.*
- *iPhone, iPod, iPod classic, iPod nano and iPod touch are trademarks of Apple Inc., registered in the U.S. and other countries.*
- *"Made for iPod," and "Made for iPhone," mean that an electronic accessory has been designed to connect specifically to iPod, or iPhone, respectively, and has been certified by the developer to meet Apple performance standards. Apple is not responsible for the operation of this device or its compliance with safety and regulatory standards. Please note that the use of this accessory with iPod, or iPhone may affect wireless performance.*
- *Pandora, the Pandora logo, and the Pandora trade dress are trademarks or registered trademarks of Pandora Media, Inc., used with permission. Pandora is currently available in the U.S., Australia and New Zealand.*
- *HD Radio Technology manufactured under license from iBiquity Digital Corporation. U.S. and Foreign Patents. HD Radio™ and the HD, HD Radio, and "Arc" logos are proprietary trademarks of iBiquity Digital Corp.*

- *Sirius, XM and all related marks and logos are trademarks of Sirius XM Radio Inc. All rights reserved.*
- *BlackBerry®, RIM®, Research In Motion® and related trademarks, names and logos are the property of Research In Motion Limited and are registered and/or used in the U.S. and countries around the world. Used under license from Research In Motion Limited.*
- *Android is a trademark of Google Inc.*
- *The Android robot is reproduced or modified from work created and shared by Google and used according to terms described in the Creative Commons 3.0 Attribution License.*
- *The Bluetooth® word mark and logos are registered trademarks owned by the Bluetooth SIG, Inc. and any use of such marks by Alpine Electronics, Inc. is under license.*
- *The terms HDMI and HDMI High-Definition Multimedia Interface, and the HDMI Logo are trademarks or registered trademarks of HDMI Licensing, LLC in the United States and other countries.*
- *MPEG Layer-3 audio coding technology licensed from Fraunhofer IIS and Thomson. Supply of this product only conveys a license for private, non-commercial use and does not convey a license nor imply any right to use this product in any commercial (i.e. revenue-generation) real time broadcasting (terrestrial, satellite, cable and/or any other media), broadcasting/streaming via internet, intranets and/or other networks or in other electronic content distribution systems, such as pay-audio or audio-on-demand applications. An independent license for such use is required. For details, please visit <http://www.mp3licensing.com>*
- ©1987-2015 HERE. All rights reserved.

X110 only

- *This item incorporates copy protection technology that is protected by U.S. patents and other intellectual property rights of Rovi Corporation. Reverse engineering and disassembly are prohibited.*
- *Manufactured under license from Dolby Laboratories. Dolby and the double-D symbol are trademarks of Dolby Laboratories.*
- *Windows Media and the Windows logo are trademarks, or registered trademarks of Microsoft Corporation in the United States and/or other countries.*
- *For DTS patents, see <http://patents.dts.com>. Manufactured under license from DTS Licensing Limited. DTS, the Symbol, & DTS and the Symbol together are registered trademarks, and DTS Digital Surround is a trademark of DTS, Inc. ©DTS, Inc. All Rights Reserved.*
- **DVD** is a trademark of DVD Format/Logo Licensing Corporation.

Features

The screen design used in the Owner's Manual may differ from the actual screen.

Favorite Function

Frequently used functions such as the Audio source or Navigation are easily recalled. Register them to the Favorite screen. For details, see "Favorite Function" (page 24).

Favorite screen example

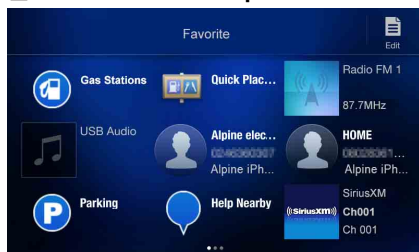

- Frequently used functions and useful functions can be customized for your convenience.
- You can register up to 54 functions.
- You cannot register a function more than once.

About Swiping the Touch Screen

You can change a screen or a page by swiping the touch screen vertically or horizontally with your finger. For details, see "Touch Screen Operation" (page 17).

Swipe the display with your finger lightly.



Switching the Audio Sources Screen to a Dedicated Screen

You can switch the Audio Sources screen to a dedicated screen by touching the icon on one of the four edges of the screen, or by swiping vertically or horizontally. For details on how to swipe the screen, see “Touch Screen Operation” (page 17).

Shortcut Setup Screen (page 19)

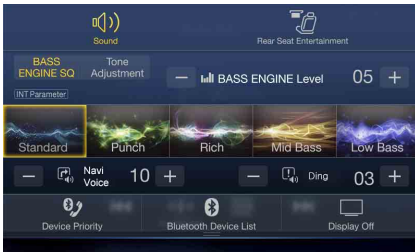

You can set the Sound Setup or Rear Seat Entertainment System.

Dual Screen (page 14)



You can switch between the displayed screens on the Dual Screen.

<Audio Sources Screen>
(USB Audio)

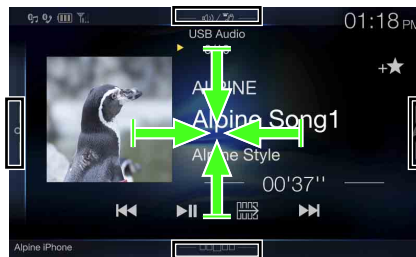

Preset button or Quick Search mode Screen *1



Menu Screen *2 (page 21)



You can make settings on the Menu Screen.

*1 The Search mode differs depending on the audio source. For details, see the operating instructions of the audio source.

*2 The screen also switches by pressing the Menu button.

About Dual Screen

Dual Screen allows you to display the Navigation and Audio/Visual screens simultaneously.

Audio full Screen



Touch [🎵], or
swipe to the right.

Touch [⬆️], or
swipe to the left.

Dual Screen

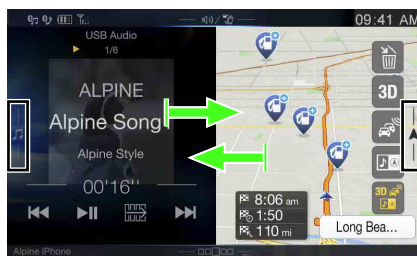

Touch [🎵], or
swipe to the right.

Touch [⬆️], or
swipe to the left.

Navigation full Screen

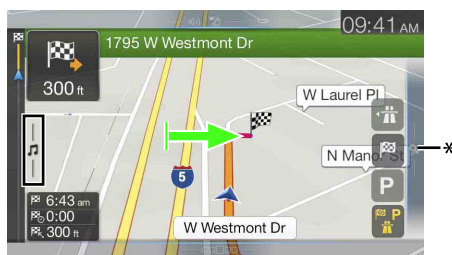

* Touch [🔍], or swipe to the left to switch to the Navigation menu screen. For details of navigation operations, refer to "Navigation System OM" in the website at <http://www.alpine-usa.com>.

Dual Screen Display Position

You can switch the left/right positions of the Audio/Visual screen and Navigation screen. Each time you touch [📏], the positions of Audio/Visual screen and Navigation screen switch.

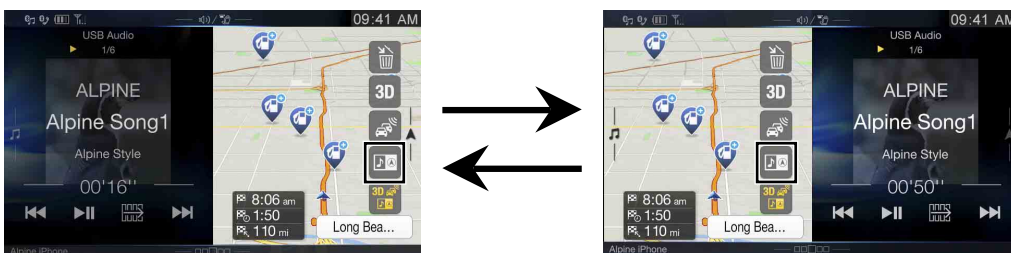

- When [📏] is not displayed, touch [📏].

Getting Started

Location of Controls

For X108U/INE-W967HD

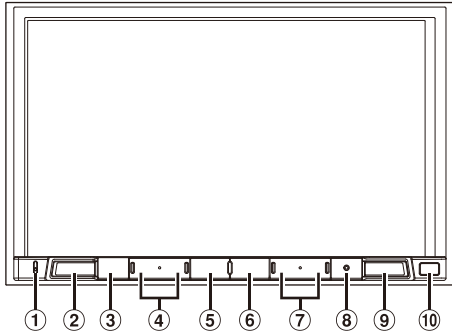

For X110

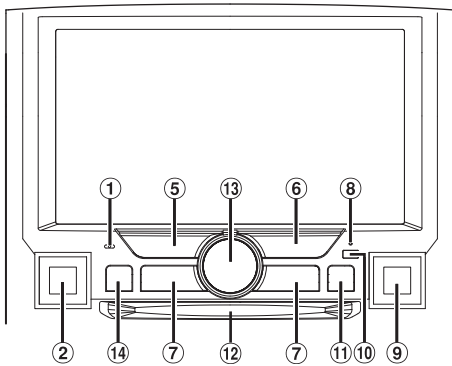

- ① **Microphone**
Used for Hands-free or Voice Control modes.
- ② **♪ (AUDIO)/ (Voice Recognition mode) button**
Displays the Audio/Visual screen. If the Audio/Visual screen is already displayed, changes the source.
When a hands-free phone with Voice Recognition is connected, press and hold for at least 2 seconds to switch to the Voice Recognition mode.
- ③ **🔇 (MUTE) button (X108U/INE-W967HD only)**
Press to activate/deactivate the mute mode.
- ④ **∨ / ∧ (DOWN/UP) button (X108U/INE-W967HD only)**
Press to adjust the volume.
- ⑤ **★ (Favorite) button**
Recalls the Favorite screen.
 - Press and hold this button for at least 2 seconds to switch to the iDataLink mode screen. (X110 only) (For X108U/INE-W967HD, when connected to the optional iDataLink module.)

- ⑥ **MENU/ (Power Off) button**
Recalls the Menu screen.
Press and hold this button for at least 5 seconds to turn the power off.
- ⑦ **◀◀ / ▶▶ button**
Press to seek down/up a station in radio mode or down/up a track, chapter, etc., in other audio/visual sources.
- ⑧ **RESET switch**
The system of this unit is reset.
- ⑨ **⏪ (NAVI/NAV) button**
Recalls the navigation map screen.
Press again to switch to Navigation menu screen.
Press and hold this button for at least 2 seconds to change to Go Home route screen. (If Home is not set yet, it will change to the Home setting screen.)
For details of navigation operations, refer to "Navigation System OM" in the website at <http://www.alpine-usa.com>.
- ⑩ **Remote Sensor**
Point the remote control transmitter towards the remote sensor within a range of 2 meters.
- ⑪ **📷 (CAMERA) button (X110 only)**
Use to display the camera image.
- ⑫ **Disc Slot (X110 only)**
- ⑬ **Rotary encoder/MUTE button (X110 only)**
Adjust the volume by turning to the left or right.
Press to activate /deactivate MUTE mode.
- ⑭ **⏏ (Eject) button (X110 only)**
Ejects a disc.

Controllable with Remote Control

This unit can be controlled with an optional Alpine remote control. For details, consult your Alpine dealer. Point the optional remote control transmitter at the remote control sensor.

About the button descriptions used in this Owner's Manual

The buttons found on the face of the unit are expressed in bold (e.g. MENU). The buttons found on the touch-screen display are shown in bold within brackets, [] (e.g. [X]).

Turning Power On or Off

Some of this unit's functions cannot be performed while the vehicle is in motion. Be sure to stop your vehicle in a safe location and apply the parking brake, before attempting these operations.

1 Turn the ignition key to the ACC or ON position.

The system turns on.

- When turned on, the system displays the last screen that was displayed before the ignition key was turned off. For example, if the unit is in radio mode when ignition is turned off, it will remain in radio mode when ignition is turned back on.

2 Press and hold the MENU/ (Power Off) button for at least 5 seconds to turn the power off.

- The unit can be turned on by pressing any button.
- The unit is a precision device. Careful handling of the unit should provide you with years of trouble-free operation.

Turning the System On

With the Alpine system, when the ignition key is turned to ACC or ON, the opening screen will be automatically displayed.

When the system is used for the first time, the language selection menu is displayed. Swipe the Language list screen vertically, then touch your choice from the list of 23 languages.

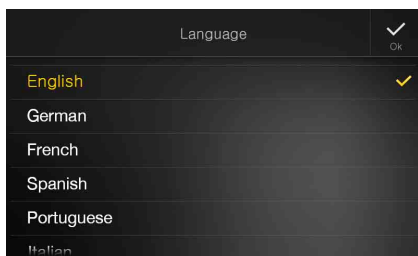

- Some of this unit's functions cannot be performed while the vehicle is in motion. Be sure to stop your vehicle in a safe location and apply the parking brake before attempting these operations.

Initial System Start-Up

Be sure to press the RESET switch when using the unit for the first time, after changing the car battery, etc.

1 Turn off the unit power.

2 Press the RESET switch with a ballpoint pen or similar pointed object.

For X108U/INE-W967HD

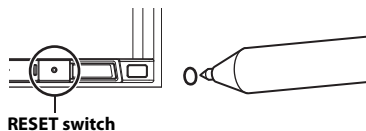

For X110

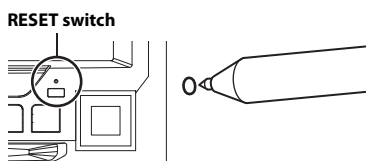

Adjusting the Volume

For X108U/INE-W967HD

Adjust the volume by pressing ∇ or \blacktriangle .

Volume decreases/increases continuously by pressing and holding ∇ or \blacktriangle .

Volume: 0 - 35

For X110

Rotate the Rotary encoder until the desired sound level is obtained.

Volume: 0 - 35

Lowering Volume Quickly

Audio Mute function instantly lowers the volume level to 0.

For X108U/INE-W967HD

1 Press the MUTE button to activate the MUTE mode.
The audio level will be 0.

2 Pressing the MUTE button again will bring the audio back to its previous level.

For X110

1 Press the Rotary encoder to activate MUTE mode.
The audio level will be 0.

2 Pressing the Rotary encoder again will bring the audio back to its previous level.

Touch Screen Operation

You can operate the system by using the touch panel on the screen.

- Be sure to touch the onscreen button lightly with the pad of your finger to avoid scratching the display.

Touch operation

Touch a button or list item on the screen lightly.



- If you touch a button and there is no reaction, remove your finger.
- Onscreen buttons that cannot be operated are dimmed.

Swipe operation

Move your finger lightly with a swipe.



Drag & Drop operation

Touch and hold the desired item, then drag it to its new location by moving your finger, then release your finger to place the item.

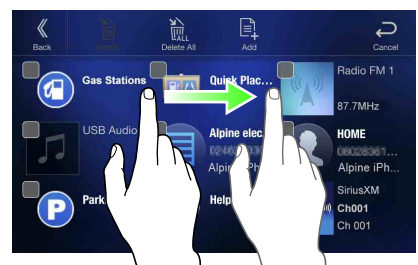

- It is not possible to narrow the screen with two fingers (pinch in) or spread the screen (pinch out).

Switching Sources

Press the  (AUDIO) button to change the source.

Switching sources using the (AUDIO) button

During audio/visual playback, press the  (AUDIO) button repeatedly to switch to the desired source.

Radio → USB/iPod*1 → Factory Media (USB/iPod)*2 → HDMI*1,3 → Pandora*1 → Bluetooth Pandora*1,4 → SiriusXM*1 or Factory SiriusXM*2 → AUX*3,5 → Bluetooth Audio*1 or Factory Bluetooth Audio*2 → Radio

- *1 When no USB flash drive/iPod/HDMI device/Smartphone/Bluetooth compatible device/SiriusXM Tuner is connected, this option is not available.
- *2 Not displayed when your car does not support the source or "Setting the Source Category" (page 48) is set to "Aftermarket." For X108U/INE-W967HD, this is also not displayed when the iDataLink module is not connected.
- *3 The name set for "HDMI Setup" (page 45), "Setting the Auxiliary (AUX) Name" (page 45), is displayed.
- *4 When Bluetooth Pandora is set to "Off", this option is not available. (page 45)
- *5 X108U/INE-W967HD only:
 - When AUX is set to "Off", this option is not available. (page 44)
 - When the iDataLink module (sold separately) is connected, the Auxiliary (AUX) mode is not available.

Switching Sources from the Menu screen

1 Press the MENU button.

The menu screen is displayed.

- You can also display the menu screen by touching [□□□□] on the lower part of the Audio source screen or by swiping upward.

The Audio source selecting area



2 Touch your desired source in the Audio source selecting area.

- In the menu screen, you can change the Audio source directly or change the order in which sources change. For details, see "About the Menu Screen" (page 21).

Operating the Function Button on the Audio/Video Main Screen

Using the Function button on the Audio/Visual main screen.

Touch [] to change to the Function mode.

■ HD Radio main screen example



Function mode



Swipe to the right or left to change to the Function mode.
To close the Function mode, touch [X].

- Depending on the Audio source, the Function mode displays from the beginning.

About Basic Operation for List Screen

Basic operations on the Setup list screen and the Search list screen.
How to display on the list screen differs depending on the selected item.

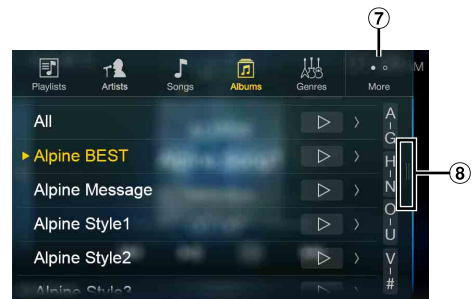
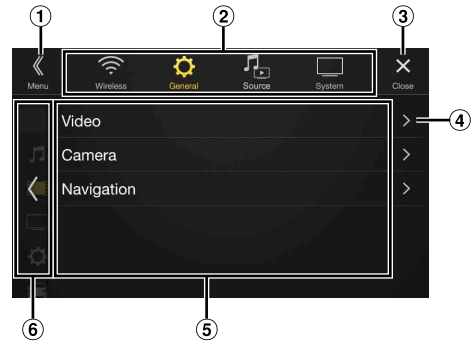

- Switches to the menu screen or the previous screen.
- Item select button
- Closes the window.
- Displays the next list page.
 - When the next selection item does not exist, the list item is not displayed.
- Lists items for selection
 - When there are more than five list items, the page can be changed by swiping vertically.
- Returns to the list screen of the page that you touched.
 - The list screens that can be displayed are up to the 2 previous pages. If you touch [<], you can recall your desired page.
- Changes the page of the Item select button ② above.
 - “●” indicates the total number of pages, “○” indicates the location of the current page.
- List screen close button
 - Touch or swipe to the left on the search screen, etc. to close the list screen.

About the Shortcut Setup Screen

Displaying the Sound Setup screen, or the Shortcut Setup screen of the Rear Seat Entertainment System screen.

Touch [🔊] / [📱] or swipe downward in the Audio source screen.



The Sound Setup screen or the Rear Seat Entertainment System Setup Screen is displayed.

■ Sound Setup screen (Tone Adjustment mode) example

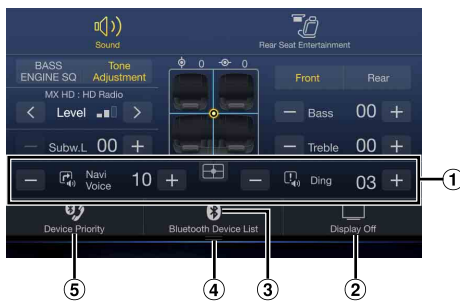

- ① You can adjust the attention tone (Ding) before the voice navigation starts and Navi voice interrupt volume (Navi Voice).
Volume: 0 - 35
- ② Button for Display Off*
- ③ Displays the registered Bluetooth Device List screen.
- ④ Touch this or swipe upward to change to the currently playing source screen.
- ⑤ Displays the Hands-free Device Primary/Secondary setting screen.
• See "Hands-free Device Primary/Secondary Setting" (page 31).

* Display Off mode

- To cancel Display Off mode, touch the screen or press any button.
- Display Off mode is canceled when the power or ACC is turned off.
- When the gear lever is shifted to the reverse (R) position and the rear camera is connected, the rear camera image is displayed.
- When a call is received on a Bluetooth-connected phone, the incoming call screen is displayed.

Sound Setup Function

■ Tone Adjustment mode

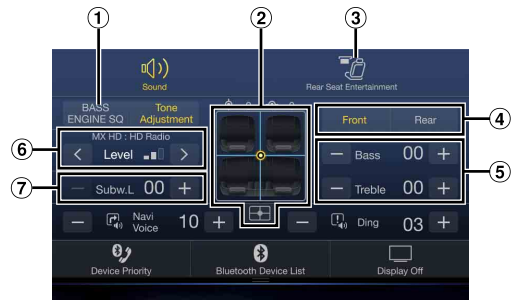

■ BASS ENGINE SQ mode

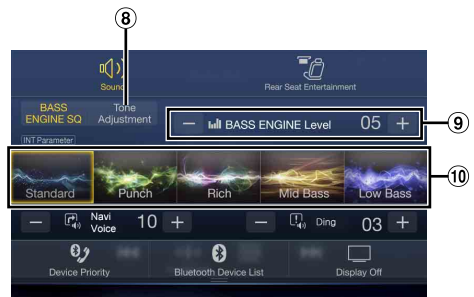

- ① Button for changing the BASS ENGINE SQ mode screen
- ② Balance/Fader Image area*¹
 - To reset to the initial settings (Balance: 0, Fader: 0), touch [🔄].
- ③ Rear Seat Entertainment Function screen switch button
 - When Setting the Rear Seat Entertainment is "Off," you cannot change the screen. For details on Rear Seat Entertainment setting, see "Rear Seat Entertainment Setup" (page 49).
- ④ Buttons for switching between Front/Rear when adjusting Bass/Treble*²
- ⑤ Buttons for adjusting Bass Level/Treble Level*^{3, 4}
- ⑥ Buttons for adjusting Media Xpander *^{1, 3}
- ⑦ Buttons for adjusting Subwoofer Level *^{1, 3, 5}
- ⑧ Button for changing the Tone Adjustment mode screen
 - If changing to the Tone Adjustment mode, BASS ENGINE SQ mode will be disabled.
- ⑨ Buttons for adjusting the BASS ENGINE Level*⁴
- ⑩ Buttons for selecting the BASS ENGINE type *⁴

*¹ You can perform a more detailed set up in "Sound Setup" (page 33).

*² You cannot switch when Front/Rear Sync in "Adjusting the Parametric Equalizer Curve (Dual HD EQ)" (page 34) is "On."

*³ When you switch to the BASS ENGINE SQ mode, the value you have set is ignored.

*⁴ When the Defeat setting is "On," you cannot perform the set up.

*⁵ If the Subwoofer setting is "Off," the setting cannot be changed. See "Turning Subwoofer ON/OFF" (page 33).

Adjusting Bass Level/Treble Level

Bass Level and Treble Level can be set for each front seat and for each rear seat by touching **[Front]** or **[Rear]**.

Setting item:

Bass / Treble

Setting contents:

-14 to +14 (Initial setting: 0)

- When the Sound Setup of the Shortcut Setup is selected to "BASS ENGINE SQ," you cannot perform the set up.
- Adjustment cannot be performed when Defeat is set to "On."
- The Bass adjusted setting value is interlinked with Band2 of Dual HD EQ, and the Treble adjusted setting value is interlinked with Band8.

Setting the BASS ENGINE SQ

Setting the BASS ENGINE Type

Creating the ideal Bass impact for your musical taste using BASS ENGINE SQ.

Setting contents:

Standard (Initial setting) / Punch / Rich / Mid Bass / Low Bass

- | | |
|-----------|--|
| Standard: | Mild low-end boost with mid-range focus for front-centre staging. |
| Punch: | Mid-bass punched up with mid-range impact. |
| Rich: | Accented highs and mid-bass giving outstanding balance for all types of music. |
| Mid Bass: | Strong high frequency emphasis with mid-bass boost for more low-end attack. |
| Low Bass: | Strong, low-bass boost with extended highs for a very dynamic sound. |

Adjusting the BASS ENGINE Level

You can adjust the BASS ENGINE Level.

Setting item:

BASS ENGINE Level

Setting contents:

0 to 6 (Initial setting: 3)

- The BASS ENGINE Level 0 of the BASS ENGINE SQ is common to all the types.

About setup when the external power amplifier is connected

In order to optimize the BASS ENGINE SQ mode, we recommend the following procedure to set up the power amplifier.

Use your favorite music to make the following amplifier adjustment.

- 1) Set GAIN of the power amplifier to "MIN."
- 2) Set the Crossover Mode Sector switch to "OFF"
 - If the switch has no "OFF" position, set as near as possible to full range.
- 3) Set the BASS ENGINE Level to "03."
- 4) Play a song of the genre you frequently listen to, and adjust GAIN of the power amplifier.

Rear Seat Entertainment Function

The Rear Seat Entertainment function independently routes different sources to the front and the rear side of the car. For example, while listening to the radio or other audio sources in the front, HDMI can be enjoyed at the rear with optional rear monitors and headphones.

Rear Seat Entertainment System Setup screen

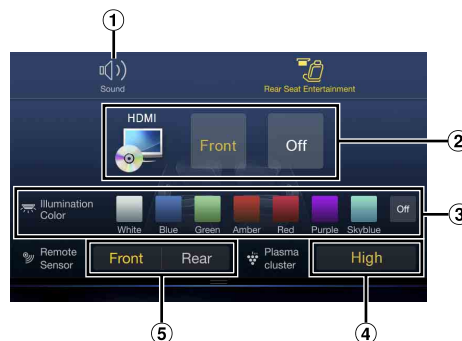

- ① Button for changing to the Sound Setup screen.
- ② Visual source selection area that is displayed on the Rear monitor.*1, 2
Touch the source icon displayed on the Rear monitor.
Front: The image and sound of the same visual source as the unit are output.
Off: Stops output to the Rear monitor.
- ③ Illumination Color button*3
The color coordination select button of the Rear monitor:
White/Blue/Green/Amber/Red/Purple/Skyblue/Off
(This function is depended on Over Head Monitor)
- ④ Plasmacluster air volume adjustment button*4
Whenever you touch the button, you can change the air volume.
Off → Low → Mid → High → Off
 - While the plasmacluster is operating, the indicator is displayed on the Audio source screen.
- ⑤ Remote Sensor
You can set whether the sensor on Rear monitor receives remote control operation, or the unit receives it.

*1 The visual source that can be output to the Rear monitor is "HDMI/DVD," "iPod Video," and "AUX." When the unit plays back the visual source, you can only select the same visual source as the unit.

*2 When selecting AUX and iPod video source selection, the "Setting the Additional AUX BOX" (page 50) is set to "On" and an optional external AUX distribution box is required.

*3 When the Illumination Color in "Setting the Rear Seat Entertainment System" (page 49) is set to "Off," the Illumination Color button is not displayed.

*4 When the Plasmacluster in "Setting the Rear Seat Entertainment System" (page 49) is set to "Off," the Plasmacluster air volume adjustment button is not displayed.

- If the same visual source is being output to both the unit and the Rear monitor when an incoming/outgoing call is made, the visual/audio output to the Rear monitor is interrupted temporarily depending on the source.
If different visual sources are being output to the unit and the Rear monitor, visual/audio output to the Rear monitor continues without interrupting playback.

About the Menu Screen

In the menu screen, you can select the audio source and perform various setups or operations on the unit.

Press the MENU button.

The menu screen is displayed.

- You can also display the menu screen by touching [□□□□□] on the lower part of the Audio source screen or by swiping upward.



Menu screen example

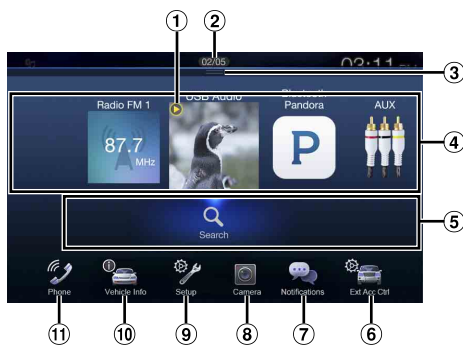

- Displays the currently playing audio source.
- Displays the total number of the audio sources that can be selected. Also displays the current position, counting from the leftmost audio source.
- Touch or swipe downward to return to the Audio source screen.
- Audio source select area
 - Touch your desired source icon to change the audio source.
 - Swiping to the right or left in the Audio source select area, you can change one audio source at a time. Moreover, swiping to the right or left outside the Audio source select area (upper and lower sides), you can change pages of the Audio source select area.
 - The source icon displayed in the Audio source select area is the one checked on the Edit menu screen. For details on how to display/hide the source icon, see "Edit Menu" (page 21).
- Displays Preset No, and information of the Search mode, etc., located in the middle of the Audio source select area.
 - Touch the desired preset number or the Search mode to change the audio source directly.
 - The displayed information differs depending on the audio source. Some sources are not displayed.
- External Accessory Control button
 - Is displayed when the optional External Accessory Control module is connected and "Setting the External Accessory Control" is set to "On" (page 50).
 - You can operate the external accessories from this unit. For details, see "External Accessory Control Operation" (page 96).

- Notification button*1
 - Use to display the Facebook Notification List on the connected smartphone via this unit. (page 28)
 - When there is no Notification, "No Notifications." will be displayed.
- Camera button*2
 - Displays camera images. (page 90)
- Setup button
 - Displays the Setup screen. (page 29)
- Vehicle Info button*3
 - Displays the iDataLink Info mode screen. (page 94)
- Phone button*4
 - Displays the Phone menu screen. (page 79)

- *1 Displays when Tunelt is set to "USB (iPhone)" or "Bluetooth (Android)," and when a smartphone with Tunelt App installed is connected. (page 27)
- *2 Displays when the Camera Select is set to "Front," "Rear," or "Other" (page 46). Also, when the unit is connected to the optional Multi Camera Interface module, the camera image set in "Setting a Default Camera" (page 48) is displayed.
- *3 Displayed only when the unit is connected to the iDataLink module.
- *4 Displays when the Bluetooth setting is set to "On." (page 30)

Edit Menu

You cannot operate the Edit Menu screen while driving.

Your vehicle must be parked with the ignition key in the ACC or ON position. For details, see "To display the Setup Menu screen" in "Setup Operation" (page 29).

In the Edit Menu screen, you can change the audio source order or set the display/hide settings.

1 Touch the desired source icon in the Menu screen for at least 2 seconds.

A checkbox (□ or ☑) is displayed on the upper left area of the source icon and switches to the edit mode.



- The source icon displayed in the Edit Menu screen is displayed only when usable setup and conditions of each Audio source are fulfilled. For details on setup and conditions of each audio source, see "Switching Sources" (page 17).

Changing the order of Audio source

Drag and drop the source icon to the desired location.

Hiding/Displaying Audio source

Place a check in the checkbox (☑) to display the Audio source icon. Uncheck the checkbox (□) to hide it.

- You cannot hide the icon of a source that is currently playing.

2 Touch [Done].

The editing content is confirmed, and returns to the menu screen.

- Editing here is reflected in the order of (AUDIO) button touching and change of the Audio source. (page 17)

About the Indicator Display

The Indicator Bar at the bottom of the screen displays various types of information, like the current time.



- ① Lights up when connected to a Bluetooth compatible device. (Does not display when connection is set to OFF.)

: Bluetooth connection to audio device

: Bluetooth connection to Hands Free Phone
Blinks while reconnecting.

- ② Indicates the battery level of the connected Bluetooth device*.

Battery Level	Level 3	Level 2	Level 1	No Battery
Icon				

This may not be displayed depending on the connected Bluetooth device. Whenever one battery level decreases, the alarm sounds.

- ③ Indicates the signal strength level of the connected Bluetooth compatible device*.

Displayed when Bluetooth setting is ON.

0	1	2	3	No Service
				No Service

- ④ Plasmacluster indicator

Indicates the setting value (Low/Mid/High) selected in "Plasmacluster air volume adjustment."

- ⑤ The clock display

You can switch between the 12 hour display and 24 hour display options.

For details of navigation operations, refer to "Navigation System OM" in the website at <http://www.alpine-usa.com>.

- ⑥ Bluetooth devices Name*

* When you connect two Hands-Free Phones, the information of the Bluetooth device set to Primary is displayed.

Opening screen Customization

You can set a BMP image that is stored on a USB flash drive as the opening screen.

This setting requires the following image format, folder name and file name.

Usable file format:

- BMP image
- Image size: 800 × 480 pixels (RGB 24 bit or less/number of color bit: 24, 8, 1 bit)
- Compression format: non-compressed
- Folder name*¹: **OPENINGFILE**
- File name*²: **openingfile.bmp**

- 1 Connect the USB flash drive to the USB extension cable.**
A message confirming the opening screen change is displayed.

- 2 Touch [OK].**
An update indicator "⌂ (Loading)" is displayed, and update for the opening screen starts.

- 3 After the update is complete, the following message is displayed.*³**

"The logo has been updated successfully! Please remove USB memory and press OK."

- 4 After removing the USB flash drive, touch [OK].**
The opening screen setting is complete.

*¹ Be sure to save the folder to the first layer of the USB flash drive.

*² Only one BMP image can be set as the opening screen.

*³ If "Customization failed," is displayed, touch [OK] and then check that the folder name, file name and file format are correct.

- Do not perform the following actions during the update.
 - Do not turn off the ACC to the car.
 - Do not unplug the USB flash drive.
 - Do not turn off or operate the unit.
- To return the opening screen to its original image, you must Clear All Settings. Be careful of this operation, as your other settings are also initialized. For details, see "Initializing the System" (page 41).

How to Input Characters and Numbers (Keypad)

The displayed screens and procedures may vary slightly depending on the function used, but the basic input method is the same.

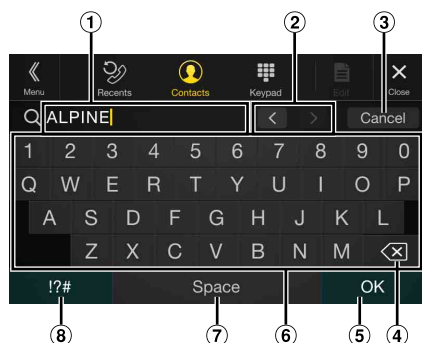

- ① Input screen area.
- ② Cursor position alteration switch
- ③ Cancel
Keypad mode finishes.
- ④  (Delete)
Returns to the previous character and erases it.
Touching here for more than 2 seconds will erase all input characters.
- ⑤ Input number is confirmed.
- ⑥ Character keypad
- ⑦ Space
- ⑧ Special character selector switch
The Alphanumeric/Special characters/Symbols selection popup is displayed.
Touch the desired character type.

Favorite Function

Using the Favorite Function

This unit enables you to recall functions easily by registering frequently used items such as the Audio source, the navigation search function, etc. to the Favorite screen. You can recall any of these items easily.

1 Press the ★ (Favorite) button.

The Favorite screen is displayed.

Favorite screen example



- ① Changes to the Edit screen used for registering items or changing names.
- ② Favorite registration item
Swipe to the left and right to change the pages. You can add up to 6 pages.
- ③ Indicates the location of the currently displayed Favorite screen.
Swipe to the left and right to change the pages. You can add up to 6 pages.

2 Touch your desired Favorite registered item.

The desired item is displayed.

- When making a phone call by choosing shortcut dialing, after the message of confirmation of outgoing phone calls is displayed, touch [Call]. For details, see “Calling by Favorite Function” (page 81).

Editing the Favorite Screen

You cannot edit the Favorites screen while driving.

Your vehicle must be parked with the ignition key in the ACC or ON position. For details, see “To display the Setup Menu screen” in “Setup Operation” (page 29).

1 Touch [Edit] (Edit).

A checkbox is displayed on the upper left area of the registration icon and it changes to Edit mode.



Setting item:

Item registration / Item name change / Icon change / Layout change / Item deletion

2 After editing is complete, touch [Back] (Back).

3 After the caption for the confirmation is displayed, touch [OK].

4 Editing is complete and the screen switches to the Favorite screen.

- If you touch [Cancel] while editing, the edits are reset and the screen returns to the previous Edit screen.

Registering Items

1 Touch [Add] (Add).

The items to be added (categories) are displayed.

2 Touch the desired item to be added (category).

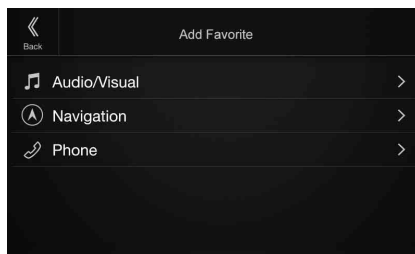

3 Choose the desired item to be added.

- You can add up to 54 items.
- You cannot register an item more than once.

■ Audio/Visual

[Radio]*1 / [USB/iPod] / [Factory Media (USB/iPod)]*2 / [HDMI] / [Pandora] / [Bluetooth Pandora] / [SiriusXM]*3 or [Factory SiriusXM]*2,3 / [AUX]*4 / [Bluetooth Audio] or [Factory Bluetooth Audio]*2

- *1 You can choose the frequency from Preset 1 - 12, registered into each FM1/FM2/AM band of HD Radio or RBDS.
- *2 Not displayed when your car does not support the source or "Setting the Source Category" (page 48) is set to "Aftermarket." For X108U/INE-W967HD, this is also not displayed when the iDataLink module is not connected.
- *3 You can choose a channel registered to Presets 1 - 18.
- *4 X108U/INE-W967HD only:
 - Displayed when "AUX" is selected in "Setting the AUX Mode" (page 44).
When "AUX" is selected, the source name set in "Setting the Auxiliary (AUX) Name" (page 45) is also displayed in the Favorite screen.
 - When the iDataLink module (sold separately) is connected, the Auxiliary (AUX) mode is not available.
- You can also register directly by touching [+★] in the Audio source screen.



However, if it is already registered, [+★] is not displayed.

■ Navigation

[Specific Place]:

You can display places registered in Favorite and set your destination.

[Quick Place Search]:

Displays the address search keypad.

[Help Nearby]:

Displays the nearby search screen.

[Place Categories]:

Displays the selected Place Categories list.

- For details of navigation operations, refer to "Navigation System OM" in the website at <http://www.alpine-usa.com>.

■ Phone (Shortcut Dialing)*5

You can register the user's shortcut dialing stored in the Phone Book.

- If multiple phone numbers are stored, select a number you want to register.
 - You can register directly by touching [+★] of the Contacts list. (page 79)
 - You can change the icon you registered. (page 25)
- *5 You can only select Phone when a mobile phone is connected. For details on how to register a mobile phone and downloading Phone Book, see "Bluetooth Operation" (page 79).

Changing Item Names

1 Touch the text area of the registered item.



The Input User Name screen (Keypad) is displayed.

2 Input the name and touch [OK].

- For details on how to input characters using the keypad, see "How to Input Characters and Numbers (Keypad)" (page 23).

Changing Icons (only the Shortcut Dialing and Navigation icons)

You can change the icons of Shortcut Dialing and Navigation category. The following example explains how to change the Shortcut Dialing icon. Perform the same procedure to change the Navigation category icon.

1 Touch the icon that you want to change.

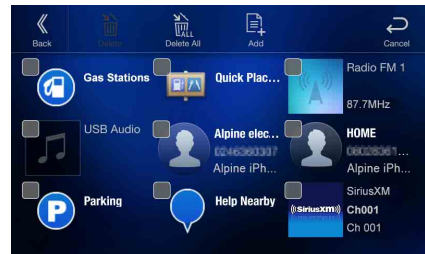

The icon list is displayed.

2 Touch the icon you want to change from the icon list.

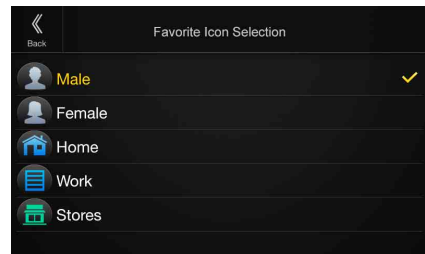

The icon is changed to the selected icon.

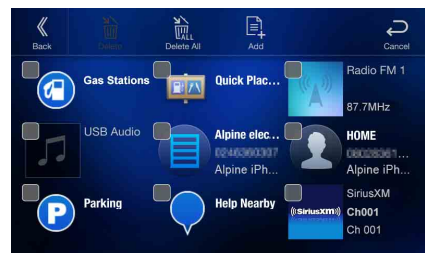

Changing the Layout

Drag and drop the item to the desired location.



The item location is changed.

- When you move to other pages, switch pages, or when you make a new page and move to another, drag to the end of the screen, and lift your finger after the page changes.

Deleting Items

When deleting a selected item

- 1 Touch the checkbox at the left of the item you want to delete and place a check (☑) in it.



- 2 Touch [🗑️] (Delete).

The selected item will be deleted.

When deleting all items

Touch [🗑️] (Delete All).



All items are deleted.

Applying Alpine TuneIt App

This unit's sound tuning is programmable from a connected Smartphone. It is also possible to download specific parameters for certain vehicles from Alpine's TuneIt database stored in the Cloud. Using the Alpine TuneIt App, customized parameters can also be uploaded for others to share and rate.

Through this unit, it is also possible to receive and respond to information from Alpine's Social Network Service (SNS) available through the connected Smartphone.

The installed Alpine TuneIt App should be launched on the Smartphone before connection to the head unit.

Alpine TuneIt App, is downloadable from Apple's App Store; the Android user can download it from Google Play. For details, consult your Alpine dealer.

Before these operations, set TuneIt to USB (iPhone) or Bluetooth (Android) depending on the connected Smartphone. For details, see "Smartphone Apps Setup" (page 50).

- The application programme and related specifications and data may be deleted or terminated without notice.
- Some Alpine TuneIt App functions may not be available if the Smartphone is not in a service area or receives no signal.

Adjusting the sound via the Smartphone

After setting the above procedure, you can adjust the unit's sound function on the Smartphone.

1 Make sure the unit is powered on.

2 Launch the Alpine TuneIt App on the Smartphone. Adjust the unit's sound accordingly on the Smartphone.

- The setting cannot be done on both the Smartphone and this unit at the same time. While the sound function of this unit is set via Smartphone, the sound function settings on the unit will be displayed as "Sound APP Connected."
- In some situations, such as the unit is powered off or during a call, etc., sound setting cannot be done via the Smartphone.
- This function may not be available depending on the paired Smartphone.
- Please obey all local traffic laws while using this function.
- When "Setting the External Audio Processor" (page 49) is "On," this function is not available.

Facebook Notification Function

Some functions may be available in a future version of Alpine TuneIt App.

- Depending on the paired Smartphone, the following functions may not be available even though the Alpine TuneIt App version is updated.

Receiving Notification

When the smartphone connected to the unit receives new notifications from Facebook, the unit emits a notification sound or displays the notification screen. Set this up in the Alpine TuneIt App settings.

Notification Incoming screen example



- ① Poster's picture and name
Touch here to switch to Facebook screen.
Facebook screen is not displayed while driving.
- ② Read (Stop) button
Touch to TTS (Text To Speech) play received notification (Depending on the status, operation may not be available).
During TTS play mode, touch **[Stop]** to stop play.
- ③ Like button
For "Like" operation. (Valid when Wall Posts or Comments is received)
- ④ Notifications button
Touch to switch to Notifications List screen.
- ⑤ Close button
Close the notification screen.

Touch the desired button to operate.

- A new received Notification prompt will last for 15 seconds. If there is no operation within 15 seconds, the unit will return to normal mode.
- Touching current main screen will close the notification screen.
- Volume adjustment during TTS play can be adjusted by \wedge/\vee or the Rotary encoder (0-35). Settings will be reflected at the next TTS reproduction.
- The TTS volume is output via the car's front right and left speakers.
- While you play a Notification by TTS during iPod video mode, the TTS volume is the same as the iPod video source. The adjusted TTS volume will be reflected on the iPod video source.
- While you play a Notification by TTS during iPod video mode, the iPod VIDEO extension cable should be connected correctly. Otherwise, you will not be able to hear the TTS.

Displaying Facebook Screen

During Notification incoming or Notification List screen, you can switch to Facebook screen.

Facebook screen example

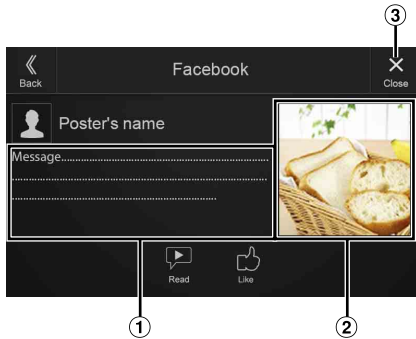

- ① Message content
- ② Poster's photo
- ③ Close button: Close the Facebook screen.

Touch the poster's picture and name to switch to the Facebook screen.

The detailed information of Notification is displayed.

- Touch [◀] (Back) to return to Notifications List screen.
- Depending on the status, contents of message and photo may not be displayed.
- In some situations, such as the unit is powered off or during a call, etc., Notification of the Smartphone will not be prompted by this unit.
- Facebook screen is not displayed while driving.

Displaying Notification List

You can view the received Notification from Facebook in the connected Smartphone via this unit.

Notification List screen example

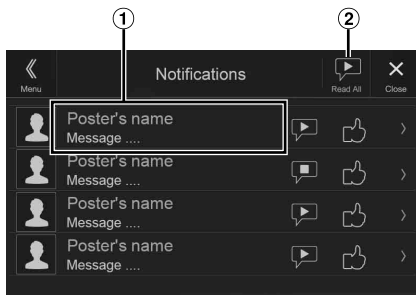

- ① Poster's Name and Message
Messages are not displayed while driving.
- ② Touch [Read All]/[Stop] to play/stop all Notifications.

- You can switch to the Notification List screen from the Menu screen.
- Touch [X] to return to Current screen.
- Depending on the status, some functions may not be available.
- The displayable amount of the Notification list depends on the connected Smartphone.

Setup

As the X110 is for specialized vehicles, its initial settings differ from the values shown in this manual.

Setup Operation

To display the Setup Menu screen:

Your vehicle must be parked with the ignition key in the ACC or ON position. To do this, follow the procedures below.

- 1 Bring your vehicle to a complete stop at a safe location. Engage the parking brake.
- 2 Release the parking brake. (For safety, release the parking brake while depressing the foot brake pedal).
- 3 Engage the parking brake again.

- For automatic transmission vehicles, place the transmission lever in the Park position.

Now, the locking system for the Setup operation has been released. Engaging the parking brake can reactivate the Setup Menu, as long as the car's ignition has not been turned off. It is not necessary to repeat the above procedure (1 through 3) of "To display the Setup Menu screen."

Each time the ignition is turned OFF, perform the procedure of "To display the Setup Menu screen."

- 3 Touch the required setting icon on the upper part of the Setup main screen or swipe the list area vertically, then touch the setting item.

Setting items:

Wireless: See "Wireless (Bluetooth) Setup" (page 30).

General: See "General Setup" (page 32).

Source: See "Source Setup" (page 42).

System: See "System Setup" (page 45).

- 1 Press the MENU button.

The Menu screen is displayed.

- You can also display the menu screen, by touching [□□□□□] on the lower part of the Audio source screen or by swiping upward.



[Setup] button

- 2 Touch [Setup].

The Setup main screen is displayed.



Wireless (Bluetooth) Setup

[Wireless] is selected on the Setup main screen in step 3. See “Setup Operation” (page 29).

Wireless Setup Menu screen



<Setting items>

Bluetooth	
Bluetooth Information*	
Set Bluetooth Device*	
Hands-free Device Priority*	
iPhone Auto Pairing*	
Device	
Passcode Change	
Default Phone Book Format	
Phone Speaker	
Microphone Select (X108U/INE-W967HD only)	

* This setting is only available when “Bluetooth” is set to “On” (☑).

The following steps 1 to 3 are common to each “Setting item” of Wireless Setup. See each section for details.

- 1** Select the desired item.
- 2** To switch the setting, touch [<], [>], [+], [-], or mark the checkboxes “Off” (☐) or “On” (☑).
 - If “>” appears, there is a further hierarchy. Touch the desired item.
- 3** Touch [X] to return to the main source screen.
 - To return to the previous List screen, touch [<<] or [<] in the previous page. For details, see “About Basic Operation for List Screen” (page 18).

Bluetooth Setup

[Bluetooth] is selected on the Wireless Setup Menu screen in step 1. See “Wireless (Bluetooth) Setup” (page 30).

You can register and set up Bluetooth compatible devices.

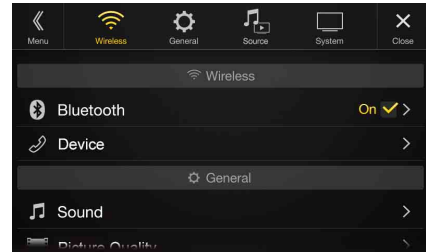

Setting item:

Bluetooth

Setting contents:

Off / On (Initial setting)

Off: Bluetooth function is not used.

On*: Select when you would like to pair your Bluetooth compatible phone with this unit.

* Turn this setting “On” to automatically connect a registered Bluetooth device whenever this unit is turned ON. See “Registering the Bluetooth Device” if no device is registered.

Displaying Bluetooth Information

Make sure the “Bluetooth” setting is “On” (☑). See “Bluetooth Setup” (page 30).

You can display the Bluetooth device name and device address of this unit.

Setting item:

Bluetooth Information

Registering the Bluetooth Device

The Bluetooth device is used when a connectable Bluetooth compatible device is searched and connected from this unit, or a new Bluetooth compatible device is registered.

Setting item:

Set Bluetooth Device

1 Touch [Q] (Search) of “No Device.”

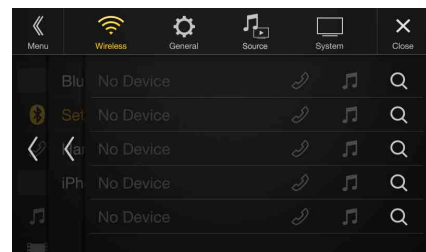

2 Touch [🎵] (Audio), [📞] (Hands-free) or [🎵/📞] (Both) of the device you want to connect from the list.

Audio: Sets for use as an Audio device.

Hands-free: Sets for use as a Hands Free Device.

Both: Sets for use as both an Audio device and Hands Free Device.

- You can register up to 5 Bluetooth compatible mobile phones.
- You can connect three Bluetooth Devices; two exclusively for Hands-Free Phone and one exclusively for Bluetooth Audio.
- When you register a Hands-Free Phone for the first time, Primary is set automatically. When you connect two Hands-Free Phones, select "Hands-free" or "Both." You can then set the priority on the Primary/Secondary setting screen. For details, see "Hands-free Device Primary/Secondary Setting" (page 31).

3 When the device registration is complete, a message appears and the device returns to normal mode.

- The Bluetooth registration process differs depending on the device version and SSP (Simple Secure Pairing). If a 4 or 6 character Passcode appears on this device, enter the Passcode using the Bluetooth compatible device.
If a 6 character Passkey appears on this device, make sure the same passkey is displayed on the Bluetooth compatible device and touch "Yes."
- If all 5 devices have been registered, you cannot register a 6th device. To register another device, you need to delete one of the other 5 devices first.

Setting the Bluetooth Device

Select one of 5 paired Bluetooth compatible devices that you previously registered.

Touch [🎵] (Audio) or [📞] (Hands free) of the device you want to connect from the Paired Device list.

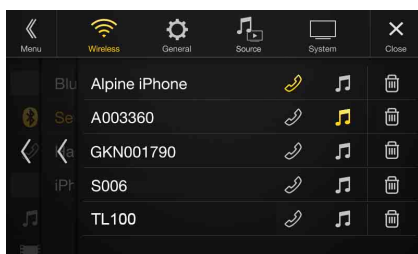

Deleting a Bluetooth Device from the list

You can delete the information of a previously connected Bluetooth compatible device.

1 Touch [🗑️] (Delete) of the Bluetooth compatible device to delete from the Paired Device list.

2 Touch [OK].

- Touching [Cancel] will cancel the setting.

Hands-free Device Primary/Secondary Setting

Make sure the "Bluetooth" setting is "On" (☑). See "Bluetooth Setup" (page 30).

When you connect two Hands-Free Phones, set the priority of the operation and the setting of incoming-outgoing calls.

Setting item:

Hands-free Device Priority

Setting contents:

Primary / Secondary

Touch the checkbox for Primary/Secondary of the device names that are registered to the unit to set them.

- When connected to two hands-free phones, operating restrictions apply to the hands-free phone registered to Secondary. For details, see "Hands-free Phone Control" (page 79).

iPhone Auto Pairing Setting

Make sure the "Bluetooth" setting is "On" (☑). See "Bluetooth Setup" (page 30).

When an iPhone is connected via USB and it is not on the Registered Device list, it will be paired automatically.

Setting item:

iPhone Auto Pairing

Setting contents:

On / Off (Initial setting)

On: Performs iPhone Auto Pairing setting.

Off: Does not perform iPhone Auto Pairing setting.

- This setting supports iPhones with iOS Ver.5.5 or later.
- When more than 5 Bluetooth devices are registered, Auto Pairing does not start.

Device Setup

[Device] is selected on the Wireless Setup Menu screen in step 1. See "Wireless (Bluetooth) Setup" (page 30).

You can make various settings for a Bluetooth compatible device.



Setting the Passcode

You can set the code for connecting with a Bluetooth compatible device.

Setting item:

Passcode Change

1 Enter a 4-digit passcode (old), and then touch [OK].

- The initial number is 0000.
- For details on how to input the numeric keypad, see "Numeric Keypad Input Operations" (page 75).

2 Enter a 4-digit passcode (new), and then touch [OK].

- 3** Enter the passcode that you entered in step 2 again, and then touch [OK].

Changing the Character Code of the Phone Book

You can select the character code that is used when transferring the phone book or history from a mobile phone. If unreadable characters appear in the transferred data, select the correct character code.

Setting item:

Default Phone Book Format

Setting contents:

Latin-1 / Latin-9 (Initial setting) / Russian / Chinese / Thai / Arabic / UTF-8 / UTF-16LE / UTF-16BE

Latin-1:	ISO 8859-1
Latin-9:	ISO 8859-15
Russian:	ISO 8859-5
Chinese:	GB18030
Thai:	CP874
Arabic:	CP1256
UTF-8	
UTF-16LE	
UTF-16BE	

Selecting the Output Speaker

You can select which speaker in the car will output the audio from the phone.

Setting item:

Phone Speaker

Setting contents:

All (Initial setting) / Front Left / Front Right / Front Left + Right

All:	The sound is output from all speakers in car.
Front Left:	The sound is only output from the front left speaker.
Front Right:	The sound is only output from the front right speaker.
Front Left + Right:	The sound is output from the front left and front right speakers.

- The setting cannot be adjusted during a phone call. Adjust the setting before placing a call.
- This option is not available when “External Audio Processor” (page 49) is set to On.

Setting the Microphone Select (X108U/INE-W967HD only)

You can select the built-in microphone or the supplied microphone as a Hands-Free Microphone.

Setting item:

Microphone Select

Setting contents:

Built-in (Initial setting) / Add-on

Built-in:	Use the built-in microphone.
Add-on:	Use the supplied microphone.

General Setup

[General] is selected on the setup main screen in step 3. See “Setup Operation” (page 29).

■ **General Setup Menu screen**

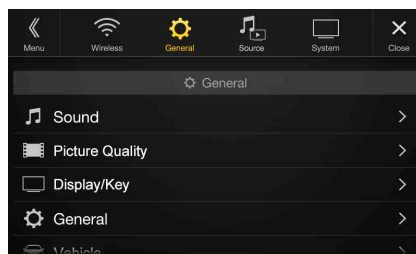

<Setting item>

Sound	
Balance / Fader *1	
Rear Speaker*2	
Subwoofer*2	
Subwoofer Level*1, 2, 3, 5	
Subwoofer Phase*2, 3	
MX HD*1, 4, 5	
EQ Presets*4, 5	
Dual HD EQ*4, 5	
X-Over*5	
Time Correction (TCR)	
Defeat	
Source Volume Setup	
Caller Level	
Microphone Level	
Ring Tone Level	
Key Sound Feedback	
Mute While Backing Up	
Default Sound Settings	
Picture Quality	
Video*6	
Camera*7	
Navigation	
Display/Key	
Screen/Lighting	
Screen Color	
Illumination Color (X108U/INE-W967HD only)	
Text Scroll	
Artwork Position	
General	
Language	
Format	
About	
Demo Mode	
Vehicle	
Installation Status	

*1 You can make this setting in the Sound Setup screen of the Shortcut Setup. For details, see “Sound Setup Function” (page 19).

- *2 You can also make the setting in the Bal./Fad. screen.
For details on how to adjust, see "Setting the Balance/Fader/Rear Speaker/Subwoofer" (page 33).
- *3 This setting is only available when "Subwoofer" is set to "On" (☑).
- *4 When the Defeat setting is "On," you cannot perform the set up.
- *5 When the Sound Setup of the Shortcut Setup is selected to "BASS ENGINE SQ," you cannot perform the set up.
- *6 "Video" can be selected while a video is playing.
- *7 The camera names are not displayed when Camera Select (page 46) is set to "Off."

The following steps 1 to 3 are common to each "Setting item" of General Setup. See each section for details.

- 1** Select the desired item.
- 2** To switch the setting, touch [\langle], [\rangle], [$+$], [$-$], or mark the checkboxes "Off" (☐) or "On" (☑).
 - If ">" appears, there is a further hierarchy. Touch the desired item.
- 3** Touch [\times] to return to the main source screen.
 - To return to the previous List screen, touch [\ll] or [\llcorner] in the previous page. For details, see "About Basic Operation for List Screen" (page 18).

Sound Setup

[Sound] is selected on the General Setup Menu screen in step 1. See "General Setup" (page 32).

You can set up items related to the sound quality.

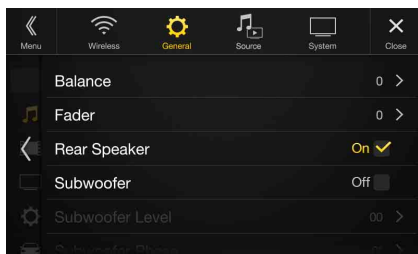

Setting the Balance/Fader/Rear Speaker/Subwoofer

Set Balance/Fader/Rear Speaker/Subwoofer/Subwoofer Level/Subwoofer Phase in the Bal./Fad. screen.

Setting item:

Balance*1 / Fader*1 / Rear Speaker / Subwoofer*2 / Subwoofer Level*1,2 / Subwoofer Phase*1

- *1 When selecting either of the above setting items, the Bal./Fad. screen is displayed.
- *2 When the Sound Setup of the Shortcut Setup is selected to "BASS ENGINE SQ," you cannot perform the set up.

Fad./Bal. screen

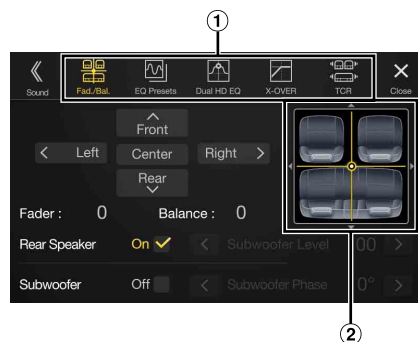

- ① Enables you to change to each setting screen.
- ② Balance/Fader Image area

Setting the Balance/Fader

Touch the desired point within the image area. Or touch [\wedge] [\vee] [\langle] [\rangle].

Balance:

L15 to R15

Fader:

F15 to R15

- To reset to the initial setting (Balance: 0, Fader: 0), touch [Center].

Rear Speaker Setting

You can set the rear speaker output to "Off."

Setting item:

Rear Speaker

Setting contents:

On (Initial setting) / Off

Turning Subwoofer ON/OFF

If an optional subwoofer is connected to the unit, make the following setting.

Setting item:

Subwoofer

Setting contents:

On / Off (Initial setting)

Adjusting the Subwoofer Level

You can set the Subwoofer level when a Subwoofer is connected.

Setting item:

Subwoofer Level

Setting contents:

0 to 15 (Initial setting: 0)

- This setting is only available when "Subwoofer" is set to "On" (☑).

Setting the Subwoofer Phase

The subwoofer output phase is toggled Subwoofer Normal (0°) or Subwoofer Reverse (180°).

Setting item:

Subwoofer Phase

Setting contents:

0° (Initial setting) / 180°

- This setting is only available when "Subwoofer" is set to "On" (☑).

Setting the Media Xpander (MX HD)

Media Xpander (MX HD) makes vocals or instruments sound distinct regardless of the music source. The HD-Radio (FM)/SiriusXM, USB Flash drive and iPod/iPhone, will be able to reproduce the music clearly even in cars with a lot of road noise.

Setting item:

MX HD

- When the Defeat setting is "On," you cannot perform the set up.
- When the Sound Setup of the Shortcut Setup is selected to "BASS ENGINE SQ," you cannot perform the set up.
- The MX HD setting can be performed only when a source is currently selected.

Adjustable source (media) and setting value

HD-Radio (FM)/SiriusXM: Off (Initial setting) / Level1 / Level2 / Level3

The medium to high frequencies become more clear, and produces well balanced sound in all the bands.

Compressed Media/Factory Audio: Off (Initial setting) / Level1 / Level2 / Level3

This corrects information that was omitted at the time of compression. This reproduces a well-balanced sound close to the original.

HDMI/AUX: Off (Initial setting) / Compressed Media / Movie / Music

Choose the MX HD mode (Compressed Media, Movie, or Music) that corresponds to the media connected.

(Movie)

The dialog portion of the video is reproduced more clearly

(Music)

This disc contains a large quantity of data such as music clip. MX uses this data to reproduce the sound accurately.

- The effectiveness increases as the MX HD setting value increases Level1 → Level2 → Level3.
- You can set this for each source.
- iPod/iPhone/USB Audio/Bluetooth Audio/Pandora/Bluetooth Pandora correspond to Compressed Media.
- Factory Media (USB/iPod)/Factory SiriusXM/Factory Bluetooth Audio correspond to Factory Audio.

Equalizer Presets

10 typical equalizer settings are preset at the factory for a variety of musical source material.

Setting item:

EQ Presets

Setting contents:

FLAT (Initial setting) / POP / ROCK / NEWS / JAZZ / ELECTRONIC / HIP HOP / EASY LISTENING / COUNTRY / CLASSICAL

- Only one type can be set to ON.
- When Equalizer Presets is set, the linked Dual HD EQ settings are also changed. We recommend storing Dual HD EQ settings in a Preset in advance.
- The Equalizer Presets setting can be configured when Defeat is "Off."

Adjusting the Parametric Equalizer Curve (Dual HD EQ)

Parametric Equalizer (Dual HD EQ) can adjust the center frequency/Q Factor (bandwidth)/level in the front seats and the rear seats, respectively.

You can adjust only to the approximate frequency zone, but can then compensate by performing advanced correction of the sound.

Setting item:

Dual HD EQ

- When the Defeat setting is "On," you cannot perform the set up.
- When the Sound Setup of the Shortcut Setup is selected to "BASS ENGINE SQ," you cannot perform the set up.

1 Adjust the Dual HD EQ to your preference.

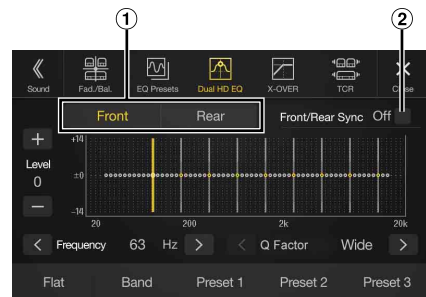

- ① Front/Rear speaker switching button
Not displayed when Front/Rear Sync is "On" (☑).
- ② Front/Rear speaker interlock button
On: When you want the Front and Rear speakers to have the same setting, set to "On" (☑).
Off: When you want to set the Front and Rear speakers independently, set to "Off" (☐).

Adjusting the Band

Touch **[Band]** to select the band to be adjusted.

Band1 → Band2 → ... → Band8 → Band9 → Band1

- You can select a band directly by touching the screen.

Adjusting the Frequency

Touch [<] or [>] of "Frequency" to adjust the frequency of the selected band.

Adjustable frequency bands:

20 Hz to 20 kHz (in 1/3 octave steps)

Band1:	20 Hz~100 Hz (63 Hz)
Band2:	63 Hz~315 Hz (125 Hz)
Band3:	125 Hz~500 Hz (250 Hz)
Band4:	250 Hz~1 kHz (500 Hz)
Band5:	500 Hz~2 kHz (1 kHz)
Band6:	1 kHz~4 kHz (2 kHz)
Band7:	2 kHz~7.2 kHz (4 kHz)
Band8:	5.8 kHz~12 kHz (8 kHz)
Band9:	9 kHz~20 kHz (16 kHz)

Adjusting the Level

Touch [-] or [+] of "Level" to adjust the level of selected band.

Setting contents:

-14 to +14 (Initial setting: 0)

Setting the Bandwidth

Touch [<] or [>] of "Q Factor" to select the bandwidth.

Setting contents:

Wide (Initial setting) / Medium / Narrow

- To adjust another band, repeat step 1, and adjust all bands.**
- To store the adjusted setting value, touch and hold [Preset 1], [Preset 2], or [Preset 3] for at least 2 seconds.**

- Band2 and Band8 are the same as the Bass and Treble controls.
- For details on setting Bass and Treble, see "Adjusting Bass Level/Treble Level" (page 20).
- Settings exceeding the frequency of adjacent bands are not available.
- While adjusting the Dual HD EQ, you should consider the frequency response of the connected speakers.
- When the Dual HD EQ is adjusted, the Equalizer Presets are overridden.
- When Equalizer Presets is set, the linked Dual HD EQ settings are also changed. We recommend storing Dual HD EQ settings in a Preset in advance.
- Touch [Flat] to initialize all values.

Calling the Dual HD EQ adjusted value

Calling the pre-set Dual HD EQ adjusted value.

Touch [Preset 1], [Preset 2], or [Preset 3] on the Dual HD EQ screen.

The setting stored in the Preset will be recalled.

Adjusting the Crossover Settings (X-Over)

Before performing the following procedures, see "About the Crossover" (page 37).

Setting item:

X-Over

- When the Sound Setup of the Shortcut Setup is selected to "BASS ENGINE SQ," you cannot perform the set up.

1 Touch [Channel] to select the channel.

Each time you touch, the channel switches.

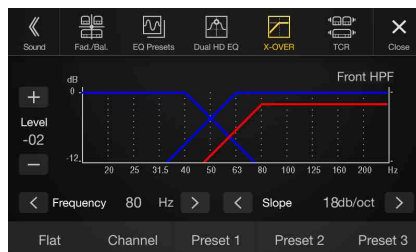

- The channel being adjusted is displayed in red.

Front HPF → Rear HPF → Subw. LPF → Front HPF

2 Adjust the crossover to your preference.

Selecting the Cut-Off Frequency

Touch [<] or [>] of "Frequency," and then select the cut-off frequency.

Setting contents:

20 / 25 / 31.5 / 40 / 50 / 63 / 80 (Initial setting) / 100 / 125 / 160 / 200 Hz

Adjusting the Slope

Touch [<] or [>] of "Slope," and then adjust the HPF or LPF slope.

Setting contents:

0 (Initial setting) / 6 / 12 / 18 / 24 dB/oct.

Adjusting the Level

Touch [-] or [+] of "Level," and then adjust the HPF or LPF level.

Setting contents:

-12 to 0 dB (Initial setting: 0)

3 Repeat steps 1 to 2 to make adjustment to the other channels.

4 To store the adjusted setting value, touch and hold [Preset 1], [Preset 2], or [Preset 3] for at least 2 seconds.

- Touch [Flat] to initialize all values.
- If the Rear Speaker setting is "Off," the Rear Speaker setting cannot be edited (page 33).
- If the Subwoofer setting is "Off," the Subwoofer setting cannot be edited (page 33).
- While adjusting the X-Over you should consider the frequency response of the connected speakers.

Calling the X-Over adjusted value

Calling the pre-set X-Over adjusted value.

Touch [Preset 1], [Preset 2], or [Preset 3] on the X-Over screen.

The setting stored in the Preset will be recalled.

Adjusting the Time Correction (TCR)

Before performing the following procedures, see “About Time Correction” (page 38).

Setting item:

Time Correction



Correction mode

1 Touch the Correction mode button.

The pop up screen for selecting the correction mode is displayed.

2 Touch [ms], [cm] or [inch] to select the mode for making adjustments.

The selected mode is displayed on the Correction mode button.

3 Touch [–] or [+] for each speaker to adjust the time or distance.

0.0 msec to 9.9 msec (0.1 msec/step)

0.0 cm (0.0 inch) to 336.6 cm (132.7 inch) (3.4 cm/step)

All speaker setting values are adjustable in the range of 15 ms or 510 cm.

4 To store the adjusted setting value, touch and hold [Preset 1], [Preset 2], or [Preset 3] for at least 2 seconds.

- Touch [Flat] to set all values to 0.0.
- If the Rear Speaker setting is “Off,” the Rear Speaker setting cannot be edited (page 33).
- If the Subwoofer setting is “Off,” the Subwoofer setting cannot be edited (page 33).

Calling the Time Correction Value

Calling the pre-set time correction value.

Touch [Preset 1], [Preset 2], or [Preset 3] on the time correction screen.

The setting stored in the Preset will be recalled.

Setting Defeat

If Defeat is “On,” MX HD, Equalizer Presets and Dual HD EQ functions are turned Off. This disables any settings made for these functions.

Setting item:

Defeat

Setting contents:

Off (Initial setting) / On

Setting the Volume for Each Source

Setting item:

Source Volume Setup → Radio / SiriusXM / Compressed Media*¹ / iPod Music / iPod Video or AUX*^{2,3} / HDMI*^{3,4} / Bluetooth Audio / Factory Audio*⁵

Setting contents:

-14 to +14 (Initial setting: 0)

*1 Compressed Media is the music data in a USB flash drive (MP3/WMA/AAC/FLAC).

*2 The item selected in AUX Source Select (iPod Video or AUX) is displayed. For details, see “Setting the AUX Mode” (page 44).

*3 The source name set in “HDMI Setup” (page 45) and “Setting the Auxiliary (AUX) Name” (page 45) is displayed.

*4 Not displayed when an HDMI device is not connected.

*5 Not displayed when an iDataLink module is not connected.

- Settable source differs depending on the connected device and settings.

Adjusting the Caller Level

You can adjust the volume of the incoming call.

Setting item:

Caller Level

Setting contents:

1 to 11 (Initial setting: 5)

Adjusting the Microphone Level

You can adjust the transmit volume, during the call.

Setting item:

Microphone Level

Setting contents:

1 to 11 (Initial setting: 5)

Adjusting the Ring Tone Level

You can adjust the receive volume, during the call.

Setting item:

Ring Tone Level

Setting contents:

1 to 6 (Initial setting: 3)

Volume Setting

You can change the volume of the sound heard when a button is touched.

Setting item:

Key Sound Feedback

Setting contents:

0 to 6 (Initial setting: 3)

Setting Audio Mute On/Off while Backing up

The sound can be muted when the shift gear lever is set to the reverse (R) position enabling you to easily hear sensors, etc., while reversing your car.

Setting item:

Mute While Backing Up

Setting contents:

Off / On (Initial setting)

Off: Does not mute.

On: Mutes when the shift gear lever is set to the reverse (R) position.

Default Sound Settings

You can restore the Dual HD EQ*/X-Over*/Time Correction*/MX HD Level/Rear Speaker/Subwoofer/Subwoofer Level/Subwoofer Phase to factory settings.

Setting item:

Default Sound Settings

Touch **[Set]**, and the confirmation message appears.

To initialize, touch **[OK]**.

* The setting values that are stored in Preset 1 to Preset 3 cannot be initialized.

About the Crossover

Crossover (X-Over):

This unit is equipped with an active crossover. The crossover limits the frequencies delivered to the outputs. Each channel is controlled independently. Thus, each speaker pair can be driven by the frequencies for which they have been optimally designed.

The crossover adjusts the HPF (high pass filter) or LPF (low pass filter) of each band, and also the slope (how fast the filter rolls off the highs or lows).

Adjustments should be made according to the reproduction characteristics of the speakers. Depending on the speakers, a passive network may not be necessary. If you are unsure about this point, please consult your authorized Alpine dealer.

	Cut-off frequency (1/3 octave steps)		Slope		Level
	HPF	LPF	HPF	LPF	
Subwoofer (LPF)	----	20 Hz - 200 Hz	----	FLAT, -6, -12, -18, -24 dB/oct.	0 to -12 dB
Rear speaker (HPF)	20 Hz - 200 Hz	----	FLAT, -6, -12, -18, -24 dB/oct.	----	0 to -12 dB
Front speaker (HPF)	20 Hz - 200 Hz	----	FLAT, -6, -12, -18, -24 dB/oct.	----	0 to -12 dB

Low range

High range

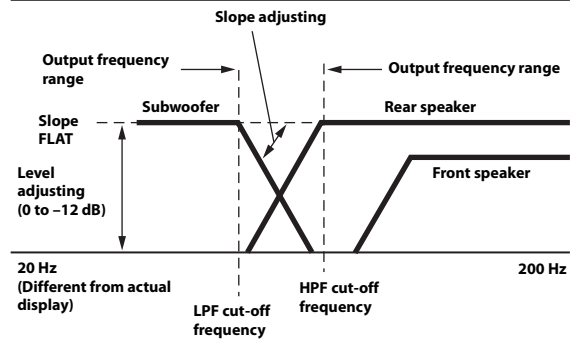

- **HPF (high pass filter):** Cuts the lower frequencies and allows the higher frequencies to pass.
 - **LPF (low pass filter):** Cuts the higher frequencies and allows the lower frequencies to pass.
 - **Slope:** The level change (in dB) for a frequency change of one octave.
 - The higher the slope value, the steeper the slope becomes.
 - Adjust the slope to FLAT to bypass the HP or LP filters.
 - Do not use a tweeter without the HPF on or set to a low frequency, as it may cause damage to the speaker due to the low frequency content.
 - Adjustment should be made according to the recommended crossover frequency of the connected speakers. Determine the recommended crossover frequency of the speakers. Adjusting to a frequency range outside that recommended may cause damage to the speakers. For the recommended crossover frequencies of Alpine speakers, refer to the respective Owner's Manual.
- We are not responsible for damage or malfunction of speakers caused by using the crossover outside the recommended value.

About Time Correction

The distance between the listener and the speakers in a car vary widely due to the complex speaker placement. This difference in the distances from the speakers to the listener creates a shift in the sounds image and frequency characteristics. This is caused by the time delay between the sound reaching the listener's right versus the left ear.

To correct this, this unit is able to delay the audio signal to the speakers closest to the listener. This effectively creates a perception of increased distance for those speakers. The listener can be placed at an equal distance between the left and right speakers for optimum staging. The adjustment will be made for each speaker in 3.4 cm steps.

Example 1. Listening Position: Front Left Seat

Adjust the time correction level of the front left speaker to a high value and the rear right to zero or a low value.

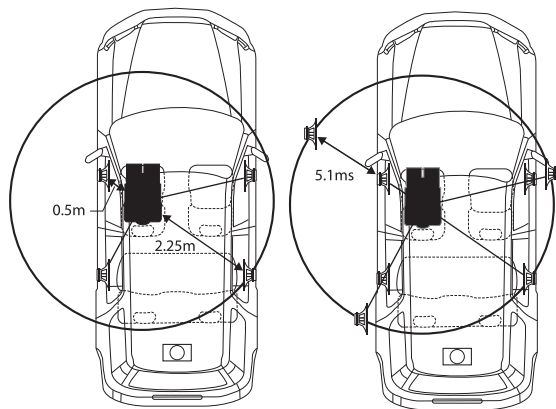

The sound is not balanced because the distance between the listening position and the various speakers is different. The difference in distance between the front left speaker and the rear right speaker is 1.75 m (68-7/8"). Here we calculate the time correction value for the front left speaker in the diagram on the above.

Conditions:

Farthest Speaker – listening position : 2.25 m (88-9/16")

Front left speaker – listening position : 0.5 m (19-11/16")

Calculation: $L = 2.25 \text{ m} - 0.5 \text{ m} = 1.75 \text{ m (68-7/8")}$

Time correction = $1.75 \div 343 * 1,000 = 5.1 \text{ (ms)}$

* Speed of sound: 343 m/s (765 mph) at 20°C

In other words, giving the front left speaker a time correction value of 5.1 ms makes it seem as if its distance from the listener is the same as the distance to the farthest speaker.

Time correction eliminates the differences in the time required for the sound to reach the listening position.

The time of the front left speaker is corrected by 5.1 ms so that its sound reaches the listening position at the same time as the sound of other speakers.

Example 2. Listening Position: All Seats

Adjust the time correction level of each speaker to almost the same level.

- 1 Sit in the listening position (driver's seat, etc.) and measure the distance (in meters) between your head and the various speakers.**
- 2 Calculate the difference between the distance correction value to the farthest speaker and the other speakers.**

$$L = (\text{distance to farthest speaker}) - (\text{distance to other speakers})$$

These values are the time correction values for the different speakers. Setting these values to make each sound reach the listening position at the same time as the sound of other speakers.

Time Correction Value List

Time Difference (msec)	Distance (cm)	Distance (inch)	Time Difference (msec)	Distance (cm)	Distance (inch)
0.0	0.0	0.0	5.1	173.4	68.3
0.1	3.4	1.3	5.2	176.8	69.7
0.2	6.8	2.7	5.3	180.2	71.0
0.3	10.2	4.0	5.4	183.6	72.4
0.4	13.6	5.4	5.5	187.0	73.7
0.5	17.0	6.7	5.6	190.4	75.0
0.6	20.4	8.0	5.7	193.8	76.4
0.7	23.8	9.4	5.8	197.2	77.7
0.8	27.2	10.7	5.9	200.6	79.1
0.9	30.6	12.1	6.0	204.0	80.4
1.0	34.0	13.4	6.1	207.4	81.7
1.1	37.4	14.7	6.2	210.8	83.1
1.2	40.8	16.1	6.3	214.2	84.4
1.3	44.2	17.4	6.4	217.6	85.8
1.4	47.6	18.8	6.5	221.0	87.1
1.5	51.0	20.1	6.6	224.4	88.4
1.6	54.4	21.4	6.7	227.8	89.8
1.7	57.8	22.8	6.8	231.2	91.1
1.8	61.2	24.1	6.9	234.6	92.5
1.9	64.6	25.5	7.0	238.0	93.8
2.0	68.0	26.8	7.1	241.4	95.1
2.1	71.4	28.1	7.2	244.8	96.5
2.2	74.8	29.5	7.3	248.2	97.8
2.3	78.2	30.8	7.4	251.6	99.2
2.4	81.6	32.2	7.5	255.0	100.5
2.5	85.0	33.5	7.6	258.4	101.8
2.6	88.4	34.8	7.7	261.8	103.2
2.7	91.8	36.2	7.8	265.2	104.5
2.8	95.2	37.5	7.9	268.6	105.9
2.9	98.6	38.9	8.0	272.0	107.2
3.0	102.0	40.2	8.1	275.4	108.5
3.1	105.4	41.5	8.2	278.8	109.9
3.2	108.8	42.9	8.3	282.2	111.2
3.3	112.2	44.2	8.4	285.6	112.6
3.4	115.6	45.6	8.5	289.0	113.9
3.5	119.0	46.9	8.6	292.4	115.2
3.6	122.4	48.2	8.7	295.8	116.6
3.7	125.8	49.6	8.8	299.2	117.9
3.8	129.2	50.9	8.9	302.6	119.3
3.9	132.6	52.3	9.0	306.0	120.6
4.0	136.0	53.6	9.1	309.4	121.9
4.1	139.4	54.9	9.2	312.8	123.3
4.2	142.8	56.3	9.3	316.2	124.6
4.3	146.2	57.6	9.4	319.6	126.0
4.4	149.6	59.0	9.5	323.0	127.3
4.5	153.0	60.3	9.6	326.4	128.6
4.6	156.4	61.6	9.7	329.8	130.0
4.7	159.8	63.0	9.8	333.2	131.3
4.8	163.2	64.3	9.9	336.6	132.7
4.9	166.6	65.7			
5.0	170.0	67.0			

Picture Quality Setup

[Picture Quality] is selected on the General Setup Menu screen in step 1. See “General Setup” (page 32). You can set up items related to an image.



Settable items differ depending on the application.

[Video] (Video media)*1:

Visual EQ / Brightness / Color / Tint / Contrast / Sharpness

[Camera]*2:

Brightness / Color / Contrast

[Navigation]:

Brightness / Contrast

*1 “Video” can be selected while a video is playing.

*2 The camera names are not displayed when “Off” is set (page 46).

Selecting the Visual EQ Mode (Factory’s setting)

You can select a mode suitable for the subject image.

Setting item:

Visual EQ

Setting contents:

Off (Initial setting) / Night / Soft / Sharp / Contrast

Off:	Initial Setting
Night:	Suitable for movies in which dark scenes frequently appear.
Soft:	Suitable for CGs and animated films.
Sharp:	Suitable for old movies where images are not clearly shown.
Contrast:	Suitable for recent movies.

- To return to the default video settings, set this function to Off. Any Visual EQ selection or changes made are reset their initial settings.

Adjusting Brightness

Setting item:

Brightness

Setting content:

-15 to +15 (Initial setting: 0)

You can adjust the brightness between MIN (-15) and MAX (+15). When it reaches the minimum or maximum point, the display shows “MIN” or “MAX” respectively.

Adjusting Color of Picture

Setting item:

Color

Setting content:

-15 to +15 (Initial setting: 0)

You can adjust the color between MIN (-15) and MAX (+15). When it reaches the minimum or maximum point, the display shows “MIN” or “MAX” respectively.

Adjusting Tint of Picture

Setting item:

Tint

Setting content:

R15 to G15 (Initial setting: 0)

Adjust the Color from R15 to G15.

Adjusting Image Contrast

Setting item:

Contrast

Setting content:

-15 to +15 (Initial setting: 0)

You can adjust the contrast between MIN (-15) and MAX (+15). When it reaches the minimum or maximum point, the display shows “LOW” or “HIGH” respectively.

Adjusting Picture Quality

Setting item:

Sharpness

Setting content:

-5 to +5 (Initial setting: 0)

Picture quality adjustment range is -5 to +5. “SOFT” and “HARD” appear as the minimum and maximum values specified.

Saving and calling the adjusted picture quality

When adjusting audio (video media), you can store the settings made for “Adjusting Brightness, Color, Tint, Contrast and Sharpness.”

Setting item:

Preset 1 / Preset 2

- 1 After completing “Adjusting Brightness, Color, Tint, Contrast and Sharpness” (page 39), touch and hold [Preset 1] or [Preset 2] to save the settings.
- 2 Touch [Preset 1] or [Preset 2] to call the saved settings.

Display/Key Setup

[Display/Key] is selected on the General Setup Menu screen in step 2. See “General Setup” (page 32). You can set up the brightness, color, display, etc., of the screen.

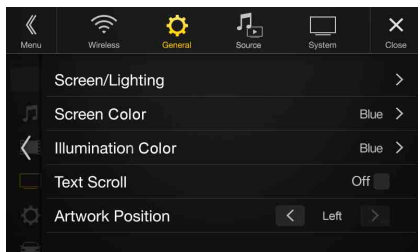

Screen/Lighting Customize

1 Touch [Screen/Lighting] in the Display/Key Setup Menu screen.

The Screen/Lighting setup screen appears.

Setting item:

Dimmer / Key Illumination Level / Screen Dimmer Level

Setting the Brightness of the Backlighting

Backlighting is provided by LEDs light built into the liquid crystal panel. The illumination control adjusts the brightness of the backlighting based on the car ambient lighting for easier viewing.

Setting item:

Dimmer

Setting contents:

Auto (Initial setting) / On / Off

Auto: Adjust the brightness of the background illumination of the monitor automatically to the brightness of the car interior.

On: Keep the background illumination of the monitor dark.

Off: Deactivate Auto Dimmer mode to keep the background illumination of the monitor bright.

- When “On” is set, the setting is also applied for the button lighting in “Adjusting the Dimmer of Button Lighting at Night” (page 40), and “Adjusting the Minimum Level of Backlight” (page 40).

Adjusting the Dimmer of Button Lighting at Night

You can adjust the brightness of the button lighting at night with the dimmer.

Setting item:

Key Illumination Level

Setting level:

-2 to +2 (Initial setting: 0)

- This setting is only available when “Dimmer” is set to “On” or “Auto.”

Adjusting the Minimum Level of Backlight

You can adjust the brightness of the backlight. This function could be used, for instance, to change the screen brightness while traveling at night.

Setting item:

Screen Dimmer Level

Setting contents:

-15 to +15 (Initial setting: 0)

You can adjust the level between MIN (-15) and MAX (+15). When it reaches the minimum or maximum point, the display shows “MIN” or “MAX” respectively.

- This setting is only available when “Dimmer” is set to “On” or “Auto.”

Switching the Display Color

You can choose from 8 different display colors.

Setting item:

Screen Color

Setting contents:

Blue (Initial setting) / Light Blue / Aqua / Red / Green / Amber / Yellow / White

Switching the Illumination Color (X108U/INE-W967HD only)

You can choose the color of the Front Panel button from one of 7 colors.

Setting item:

Illumination Color

Setting contents:

Blue (Initial setting) / Light Blue / Aqua / Red / Green / Amber / Yellow

Setting the Text Scroll

Scroll display is available if folder name, file name or tag information is entered.

Setting item:

Text Scroll

Setting contents:

Off (Initial setting) / On

Off: Turns off the scroll mode.

On*: Turns on the Auto scroll mode. Scroll display is repeated as long as the mode is turned on.

* The text scroll is not available while driving.

Switching the Artwork Position

You can set the artwork position to the center or the left.

Setting item:

Artwork Position

Setting contents:

Center / Left (Initial setting)

General Setup

[General] is selected on the General Setup Menu screen in step 1. See “General Setup” (page 32).
You can set up items related to the language, etc.



Setting the Menu Language

The Setup menu, feedback information, etc. for this unit can be changed to appear in the selected language.

Setting item:

Language

Setting contents:

English / Deutsch / Français / Español /
Português / Italiano / Nederlands / Suomi /
Norsk / Svenska / Dansk / русский язык /
Slovenčina / Polski / Český / Magyar / Ελληνικά /
עברית / العربية / Türkçe / שׂוֹאֵלֵנוּרָא /
Bahasa Indonesia

Format settings

The character code to be used for tag text information displayed on the screen can be selected from 7 character codes.

Setting item:

Format

Setting contents:

Latin-1 / Latin-9 (Initial setting) / Russian / Chinese / Thai / Arabic / Hebrew

Latin-1:	ISO 8859-1
Latin-9:	ISO 8859-15
Russian:	ISO 8859-5
Chinese:	GB18030-2005
Thai:	CP874
Arabic:	CP1256
Hebrew:	CP1255

About X110/X108U/INE-W967HD

[About] enables you to check the Serial No., Firmware Version, Model Name, and to initialize various settings.

Displaying the Product Information

You can view the version information of this product. Make note of this information and refer to it whenever you contact Alpine Tech Support or an Alpine-authorized dealer.

Setting contents:

Serial No. / Firmware Version / Model Name

Initializing the System

You can initialize all data, to restore the factory settings. Remove the USB flash drive, etc. from the system before operation

Setting item:

Clear All Settings

- 1 Touch [Reset] of “Clear All Settings.”
 - 2 After the confirmation message appears, touch [OK].
The confirmation screen appears again.
 - 3 Touch [OK].
The system starts initialization.
- Do not turn on/off the power, change the ignition key position or remove the screen panel until system restart is completed.

Setting Demo mode to Off/On

This unit has a Demonstration feature for the display. When you install and use the unit for the first time, the unit will enter demo mode automatically. To quit demo mode, set Demo mode to Off.

Setting item:

Demo mode

Setting contents:

Off (Initial setting) / On

- If you perform an operation during the Demo mode, the demonstration is temporarily stopped.

Vehicle Setup

[Vehicle] is selected on the General Setup Menu screen in step 1. See “General Setup” (page 32).

Installation Setup

Vehicle Setup enables you to check the connection status of Reverse Lead/Parking Brake Lead.

Setting item:

Installation Status

The Installation check screen is displayed.

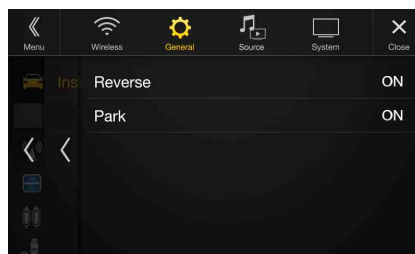

Source Setup

[Source] is selected on the Setup main screen in step 3. See “Setup Operation” (page 29).

■ Source Setup Menu screen

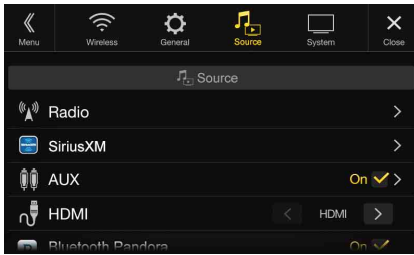

<Setting items>

Radio
FM Tuner Setting
FM Frequency Step
SiriusXM*1
Alert Setup
Alert
Alert Delete All
Favorite Team Setup
Parental Lock
Signal Indicator
AUX (X108U/INE-W967HD only)*2, 5
AUX Source Select*3
AUX Name*3
Signal*3
HDMI*4
Bluetooth Pandora

*1 This setting can be set when the SiriusXM source is being selected.

*2 This setting cannot be changed while the AUX source is being selected.

*3 This setting is only available when “AUX” is set to “On” (☑).

*4 This setting cannot be changed while the HDMI source is being selected.

*5 This setting cannot be set when the iDataLink module (sold separately) is connected.

The following steps 1 to 3 are common to each “Setting item” of Source Setup. See each section for details.

1 Select the desired item.

2 To switch the setting, touch [<], [>], [+], [–], or mark the checkboxes “Off” (☐) or “On” (☑).

- If “>” appears, there is a further hierarchy. Touch the desired item.

3 Touch [X] to return to the main source screen.

- To return to the previous List screen, touch [⏪] or [⏩] in the previous page. For details, see “About Basic Operation for List Screen” (page 18).

Radio Setup

[Radio] is selected on the Source Setup Menu screen in step 1. See “Source Setup” (page 42).

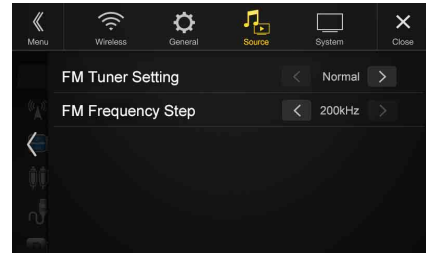

Setting the TUNER (FM) Tone Quality (Tuner Condition)

This unit can set your preferred tone quality for FM radio source.

Setting item:

FM Tuner Setting

Setting contents:

Normal (Initial setting) / HiFi / Stable

Normal: Standard setting

HiFi: High-quality setting

Stable: Control noise

- Noise may be more noticeable when HiFi is set, depending on the reception status. In this case, the Normal setting is recommended.

Setting the TUNER (FM) Frequency Step

During manual tuning, you can select the frequency step for FM analog radio station searching.

Setting item:

FM Frequency Step

Setting contents:

200kHz (Initial setting) / 100kHz

SiriusXM Setup

[SiriusXM] is selected on the Source Setup Menu screen in step 1. See “Source Setup” (page 42).

The following operations can be performed to manage the stored Songs, Artists and Sports Teams information. (To learn about how to store the information, see “Storing the desired Song/Artist” on page 67 and “Setting the Favorite Sports Team Alerts” on page 43.)

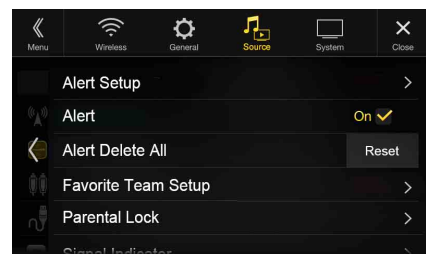

Setting the Alert individually for an Artist/Song/Favorite Team

This menu option allows you to enable the Artist/Song/Team alert for individual Artists/Songs/Teams (On or Off) or to delete individual stored Artist/Song/Team alerts (Delete).

Setting item:
Alert Setup

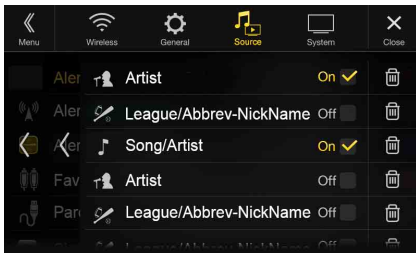

Set to "On" (☑) to enable the alert for the Artist/Song or Team.
Set to "Off" (☐) to disable the alert for the Artist/Song or Team.

- To delete the list, touch [🗑️] (Delete), and then touch [OK].

Setting ON/OFF of all Songs/Artists/Games Alert

This menu option allows you to temporarily disable the Artist/Song/Game Alerts for all Artists/Songs/Games. When the Alerts are re-enabled, individual Artist/Song/Game Alert disabled in the Alert List menu setting remain disabled.

Setting item:
Alert

Setting contents:
On / Off

If "On" (☑) is set, the alert for all stored Artists/Songs/Games is enabled.

If "Off" (☐) is set, the alerts for all stored Artists/Songs/Games are disabled.

Deleting all stored Alert

This operation will delete all alerts (artists, songs and teams) stored in memory.

Setting item:
Alert Delete All

- 1 Touch [Reset] of "Alert Delete All."**
A message is displayed.

- 2 Touch [OK] to clear the information of all stored Artist, Song, and Game alert items.**
Touch [Cancel] to cancel.

Setting the Favorite Sports Team Alerts

This menu option allows you to select your favorite teams, organized by leagues, so that you will be alerted later when your favorite teams are playing on other channels. Once selected, you will be alerted when games that those teams are playing in can be heard on a SiriusXM channel.

Setting item:
Favorite Team Setup

Setting contents:
On / Off

- 1 Touch [Favorite Team Setup].**
A sports league list is displayed.
- 2 Select the desired league.**
The display changes to the team list of the selected league.
- 3 Touch the checkboxes on the Team list to set teams to "☑" (registered) or "☐" (released).**
 - When "☑" (registered) is set, scrolling text of the Team name, Total registrations, and Remaining number of registration slots is displayed for two seconds, then the team is registered as a Favorite Team.
 - When you set a team that is registered as an Alert to "☐" (released), scrolling text for confirmation is displayed. Touch [OK] to cancel the registration.
 - The maximum number of registered Teams, Artists, and Songs is 50. For details on how to register an Artist alert or Song alert, see "Storing the desired Song/Artist" (page 67).

When the number of registered Teams, Artist, and Songs exceeds 50

If the total number of registered Teams, Artists, and Songs is already at 50 when "☑" (registered) is set, then scrolling text is displayed, asking whether you want to replace a registered Artist/Song/Team with the new one. If you want to replace one, go to step 4.

- 4 Touch [OK].**
The list of registered Artists/Songs/Teams is displayed.
 - If you want to cancel the registration of your Favorite Team, then touch [Cancel], and return to step 3.
- 5 Touch the Artist, Song, or Team name that you want to replace.**
Scrolling text of the Team name, Total registrations, and Remaining number of registration slots is displayed for 2 seconds, then the team is registered as a Favorite Team.
 - For details on deleting a registered Artist, Song, or Team beforehand, to secure a registration slot in advance, see "Setting the Alert individually for an Artist/Song/Favorite Team" (page 43).

Setting the Parental Lock

You can lock out channels with passcode protection. Channels that are locked cannot be accessed without entering the passcode. You can unlock a channel or change the passcode using this menu option.

Setting item:
Parental Lock

- 1 Touch [Parental Lock].**
A passcode input screen is displayed.

2 Touch the numeric keypad to input a 4-digit passcode.

The initial default 4-digit passcode is set to 0000.

After entering the digit, it is displayed as "*" (asterisk).

- Touch [] to delete an entered number.
- Touch [*Delete All*] to delete all entered numbers.

3 Touch [Enter].

Setting the Lock status of individual channels

4 Touch [Locked Channels].

The channels list screen is displayed.

5 Touch the checkboxes "On" () or "Off" () of the channels list to set the Parent Lock Off/On.

Clearing the Lock of ALL the locked Channels

4 Touch [Clear All Locked Channels].

5 Touch [OK] to clear the lock of all the locked channels.

Touch [*Cancel*] to cancel.

Changing the Lock Passcode

4 Touch [Edit Code].

The numeric keypad screen is displayed.

5 Use the keypad to enter the current (old) 4-digit passcode.

The initial passcode is set to 0000.

- Touch [] to delete an entered number.
- Touch [*Delete All*] to delete all entered numbers.

6 Touch [Enter] to confirm the entry.

7 Now use the keypad to enter the new 4-digit passcode.

8 Touch [Enter].

9 Then use the keypad to enter the new 4-digit passcode a second time to verify it.

10 Touch [Enter].

- Remember to keep a note of the passcode in a safe place in case you forget the code.

Signal Strength Information

While listening to a SiriusXM Channel, the Signal strength of the current channel will be displayed.

Setting item:

Signal Indicator

This menu item displays the SiriusXM signal strength as Strong, Good, Weak or No Signal.

- If the Signal Indicator reports Weak or No Signal and your vehicle is parked outside with no obstructions to the southern sky, then your SiriusXM antenna may not be properly installed or may have become damaged.

AUX Setup (X108U/INE-W967HD only)

[AUX] is selected on the Source Setup Menu screen in step 1. See "Source Setup" (page 42).

You can set up the items related to the Auxiliary device.

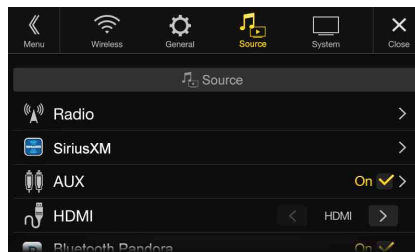

Setting item:

AUX

Setting contents:

Off / On (Initial setting)

Off: AUX source is not displayed.

On: AUX source is displayed.

Setting the AUX Mode

Make sure the AUX is set to "On" (). See "AUX Setup (X108U/INE-W967HD only)" (page 44).

Connection with external input devices is available through the AUX Input connector. An optional adapter cable is required (standard RCA to 3.5ø mini-phono plug or 3.5ø to 3.5ø mini phono plug).

You can also play back video connecting with an optional AV cable (4-pole mini AV plug to 3-RCA).

Setting item:

AUX Source Select

Setting contents:

iPod Video / AUX (Initial setting)

iPod Video: Set when connected to an iPod or iPhone.

AUX: Set when connected to an external input device.

- When an iPod video is selected or the current source is AUX, this setting cannot be adjusted.

Usable 4-pole mini AV plug

The unit accepts the following 4-pole mini AV plug pin-out:

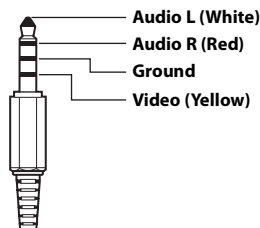

- Please check pin-out carefully before use of this product. Depending on the cable, there may be no picture and/or sound.

Setting the Auxiliary (AUX) Name

Make sure the AUX is set to “On” (☑). See “AUX Setup (X108U/INE-W967HD only)” (page 44).

Setting item:

AUX Name

Setting contents:

AUX (Initial setting) / AUX DVD / GAME / External DVD / DVD Changer / DVB-T/TV

Switching the Visual Input Signal System

You can make this setting only when AUX is set to “On” (☑). See “AUX Setup (X108U/INE-W967HD only)” (page 44).

Setting item:

Signal

Setting contents:

Auto (Initial setting) / NTSC/PAL

Auto: The video input signal type (NTSC or PAL) will be automatically selected.

NTSC/PAL: Choose the video input signal type manually.

HDMI Setup

[HDMI] is selected on the Source Setup Menu screen in step 1. See “Source Setup” (page 42).

You can set the name of an external device connected via HDMI.

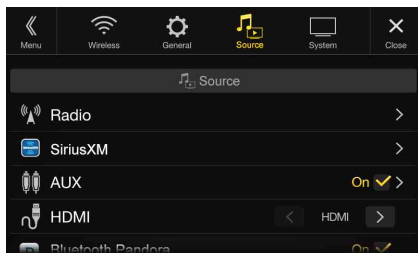

Setting item:

HDMI

Setting contents:

HDMI (HDMI 1*) (Initial setting) / DVD

HDMI Set when a smartphone is connected via HDMI.

(HDMI 1):

DVD: Set when an external DVD player is connected.

* When the HDMI selector is set to “On,” “HDMI 1” is displayed in the Setting contents. For details on setting the HDMI selector, see “Setting the HDMI Selector On/Off” (page 50).

Setting the Bluetooth Pandora®

[Bluetooth Pandora] is selected on the Source Setup Menu screen in step 1. See “Source Setup” (page 42).

To use Bluetooth Pandora, set the Bluetooth Pandora setting to “On.”

Setting item:

Bluetooth Pandora

Setting contents:

Off / On (Initial Setting)

- When “On” is set, the Bluetooth Pandora® source is displayed on the Menu screen.
- When the current source is Bluetooth Pandora, this setting cannot be adjusted.

System Setup

[System] is selected on the Setup main screen in step 3. See “Setup Operation” (page 29).

System Setup Menu screen

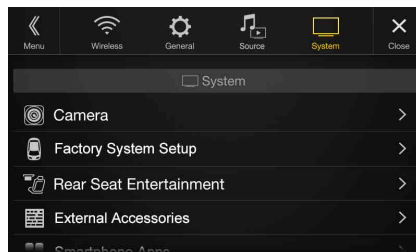

<Setting items>

Camera*1	Camera Select
	Camera Signal*2
	Guide Adjustment*3
	Camera Interrupt (Power Mode)*4
Factory System Setup	USB/iPod / SiriusXM / Bluetooth Audio
	Hands-free Connection
	Default Vehicle Screen
	Maestro Module
Rear Seat Entertainment	Rear Seat Entertainment
	Remote Sensor
External Accessories	External Audio Processor
	RSE Aux Switch Box
	HDMI selector
	External Accessory Ctrl
Smartphone Apps	Alpine Tunelt App*5

*1 When you select “Camera Selector” in “Camera Select”, the setting item is different. For details, see “Setting Multi Camera to On/Off” (page 48).

*2 When Camera Select is set to “Off”, you cannot select this item.

*3 You can select this item only when Camera Select is “Front” or “Rear.”

*4 You can select this item only when Camera Select is “Rear.”

*5 Set this setting after closing the Alpine Tunelt App.

The following steps 1 to 3 are common to each “Setting item” of System Setup. See each section for details.

- 1 Select the desired item.
- 2 To switch the setting, touch [⟨], [⟩], [+], [–], or mark the checkboxes “Off” (☐) or “On” (☑).
 - If “>” appears, there is a further hierarchy. Touch the desired item.
- 3 Touch [×] to return to the main source screen.
 - To return to the previous List screen, touch [⟨] or [⟨] in the previous page. For details, see “About Basic Operation for List Screen” (page 18).

Camera Setup

[Camera] is selected on the System Setup Menu screen in step 1. See “System Setup” (page 45).

You can set up items related to the Camera.



Setting the Camera Input

Setting item:

Camera Select

Setting contents:

Off (Initial setting) / Front / Rear / Other / Camera Selector

Front: Front camera

Rear: Rear camera

Other: Side camera, Room camera, etc.

Camera Selector*: Front Camera/Rear Camera/Side Camera connected to the optional Multi Camera Interface module.

* When selecting Camera Selector, you can set the Front Camera/Rear Camera/Side Camera to On/Off. For details, see “Setting Multi Camera to On/Off” (page 48).

Setting the Camera Signal Input

When the camera is connected, the video input signal type can be chosen.

Further setting item:

Camera Signal

Setting contents:

NTSC (Initial setting) / PAL

Switching Video Patterns for Multi View Camera

The video pattern can be changed when connected to Multi View Camera.

When Camera Select is set to “Off” or “Other,” you cannot select this item.

Setting item:

Guide Adjustment

1 Touch [Guide Adjustment].

The camera guide adjustment screen is displayed.

Multi View compatible Side Camera

2 Touch [Front] or [Rear].

The view will change to the selected view.

Multi View compatible Front Camera/Rear Camera

2 Touch [Back], [Panorama], [Corner], or [Top].

The view will change to the selected view.

- [Back] will not appear for the Front camera.

- For an explanation of video patterns, see the camera Owner’s Manual.

Adjusting the Rear/Front/Side Camera Guide

You can adjust the camera guide position.

Setting item:

Guide Adjustment

1 Touch [Guide Adjustment].

The camera guide adjustment screen is displayed.

- If the video pattern is set to “Corner (Rear/Front Camera only),” the camera guide will not be displayed.
- When you connect a Multi View compatible camera, select a Video Pattern to make a guide adjustment.
- To adjust the guide position of the Rear Camera, touch [Hitch Guide On] or [Hitch Guide Off] to display/hide the Hitch Guide. You can adjust the Hitch Guide to mark the position of the junction between your vehicle and your trailer.
- When you connect a Multi View compatible Side Camera, after selecting the Video Pattern, touch [Left steering] or [Right steering] to make the guide adjustment that matches the position of the steering wheel in your vehicle.

2 Touch [Adjust].

- If [Adjust] does not appear, proceed to step 3.

3 Touch the guide you intend to adjust.

Guide line can also be selected by touching [▼] [▲].

■ Rear Camera screen example

When Hitch Guide is set to Off

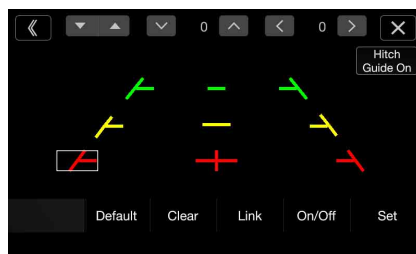

- You cannot adjust the position of the yellow guide line “—” in the center independently. It is controlled by a system to be the center of the two yellow guide lines “↘” and “↙” on the left and right, or the central green line “—” and red guide line “+”.

When Hitch Guide is set to On

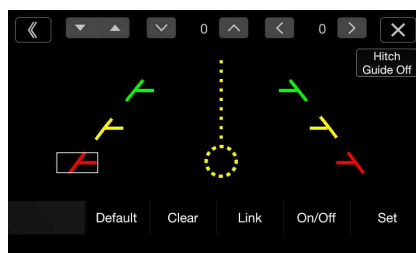

- You can adjust the Hitch Guide to mark the position of the junction between your vehicle and your trailer.

■ Front Camera screen example

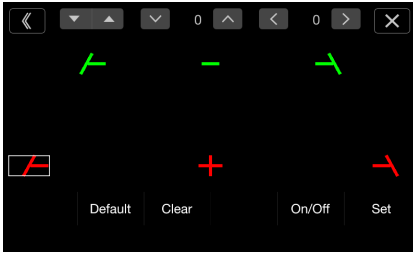

■ Side Camera screen example

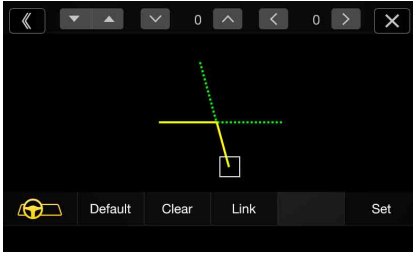

4 Touch [∨], [∧], [⟨] or [⟩] to adjust the position of the guide.

- Touching [Clear] clears adjustments and returns to the setting before guide line alteration.

5 After the adjustment is completed, touch [Set].

Adjusting Guides Simultaneously (for Rear/Side Camera only)

<Rear Camera>

1 Touch [Link].

The 3 vertical guides of the currently-selected guide link together, allowing them to be adjusted simultaneously.

■ When Hitch Guide is set to Off

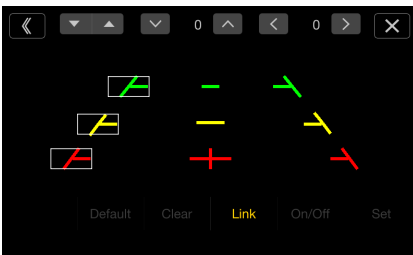

- Note on the yellow guide line “—” in the center
The yellow guide line “—” in the center is controlled by a system that locates it in the center of the two yellow guide lines, “↘” and “↙” on the left and right, or the green line “—” on the top and red guide line “+” below. Therefore you cannot move it manually.

■ When Hitch Guide is set to On

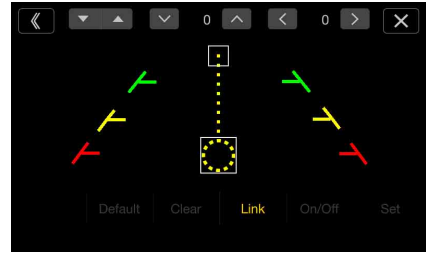

<Side Camera>

1 Touch [Link].

The 2 vertical guides of the currently-selected guide link together, allowing them to be adjusted simultaneously.

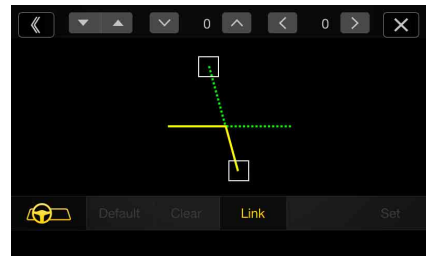

Turning Guide Display On/Off (Rear/Front Camera only)

Turning the selected guide off.

1 Touch [On/Off].

The currently selected guide will turn off.

2 To turn the guide on, touch [On/Off] again.

- Guides that are turned off are still adjustable.

Returning Guides to Default

1 Touch [Default].

A message window will appear.

2 Touch [OK].

Adjusted values will return to default settings.

Camera Interrupt Setting (Power OFF Mode) (Rear Camera Only)

You can set whether to display the rear camera image when the gear lever is moved to the reverse (R) position while the unit is turned off. You can select this item only when Camera Select is “Rear.”

Setting item:

Camera Interrupt (Power Mode)

Setting contents:

On (Initial setting) / Off

On: The rear camera image is displayed

Off: The rear camera image is not displayed

Setting Multi Camera to On/Off

When connecting the optional Multi Camera Interface module, you can connect up to 3 cameras as Front Camera/Rear Camera/Side Camera.

- When using the optional Multi Camera Interface module, select "Camera Selector" to set the "Front Camera /Rear Camera/Side Camera" to "On" (☑️)/"Off" (☐).



Setting item:

Front Camera / Rear Camera / Side Camera / Default Camera*

Setting contents:

Off (Initial setting) / On

Camera Signal:	See "Setting the Camera Signal Input" (page 46)
Guide Adjustment:	See "Adjusting the Rear/Front/Side Camera Guide" (page 46)
Camera Interrupt (Power Mode):	See "Camera Interrupt Setting (Power OFF Mode) (Rear Camera Only)" (page 47)

- * You can change the Default Camera only when you set more than one camera for Front Camera/Rear Camera/Side Camera to "On." For details, see "Setting a Default Camera" (page 48).

Setting a Default Camera

When connecting an optional Multi View Camera, you can set which camera image is displayed when you touch the Camera button on the Menu screen or press the  (CAMERA) button (X110 only).

Setting item:

Default Camera

Setting contents:

Front / Rear / Side

- The initial setting differs depending on the cameras set to "On" in "Setting Multi Camera to On/Off."

Factory System Setup

[Factory System Setup] is selected on the System Setup Menu screen in step 1. See "System Setup" (page 45).



Setting the Source Category

You can set whether the following source icon in the Menu screen is available.

Setting item:

USB/iPod (Initial setting: Both) / SiriusXM (Initial setting: Aftermarket) / Bluetooth Audio (Initial setting: Aftermarket)

Setting contents:

Both / Factory / Aftermarket

Both*:	Both the sources listed above from this unit and iDataLink module are available.
Factory:	Only the source listed above from iDataLink module is available.
Aftermarket:	Only the source listed above from this unit is available.

* USB/iPod only.

- The iDataLink source icons not displayed on the Menu screen when no iDataLink module is connected even though "Both" or "Factory" is set.
- You cannot set the source that is currently being played.

Setting the Hands-free Connection

Select to pair the Bluetooth compatible phone with this unit or the connected iDataLink module.

Setting item:

Hands-free Connection

Setting contents:

Factory / Aftermarket (Initial setting)

Factory:	Select to pair the Bluetooth compatible phone with the connected iDataLink module.
Aftermarket:	Select to pair the Bluetooth compatible phone with this unit.

- When "Factory" is selected, the screen changes to the Phone menu screen of the iDataLink module.

Setting the Default Vehicle Screen

Press and hold the ★ (Favorite) button for at least 2 seconds or touch the Menu screen (page 21) to display the Info mode screen, and then set the following.

Setting item:

Default Vehicle Screen

Setting contents:

Climate / Vehicle Info. / Gauges / Parking Assist / Last mode (Initial setting)

- Depending on the car, some setting contents or this setting item may not be displayed.

Setting the Maestro Module

You can change the setting of the connected iDataLink module.

Setting item:

Maestro Module

- Depending on the iDataLink module, the setting contents may differ.

Rear Seat Entertainment Setup

[Rear Seat Entertainment] is selected on the System Setup Menu screen in step 1. See “System Setup” (page 45).

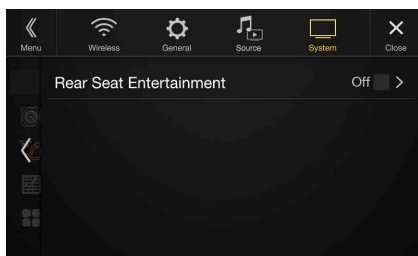

When a Rear monitor equipped with HDMI input is connected to this unit, change this setting to “On.” You can output images to the Rear monitor. For details, see “Rear Seat Entertainment Function” (page 20).

Setting item:

Rear Seat Entertainment

Setting contents:

Off (Initial setting) / On

- When this setting is “On,” you can use this unit to switch the Plasmacluster or Illumination of a Rear monitor with the Plasmacluster function or Illumination function.

Setting the Rear Seat Entertainment System

Make sure the Rear Seat Entertainment is set to “On” (☑). See “Rear Seat Entertainment Setup” (page 49).

Setting item:

Plasmacluster/Illumination Color

Setting contents:

Off (Initial setting) / On

- For details on adjusting Plasmacluster/Illumination, see “Rear Seat Entertainment Function” (page 20).
- When the Rear Seat Entertainment setting is set to “Off,” you cannot select this item.
- Set the coordination color and Plasmacluster controls on the Rear monitor to “Navi.” When set to “Rear monitor,” you cannot operate them from this unit.

Remote Sensor Setting

Make sure the Rear Seat Entertainment is set to “On” (☑). See “Rear Seat Entertainment Setup” (page 49).

For remote control operation, the remote sensor of the external device (Rear monitor, etc.) can be switched, as you prefer.

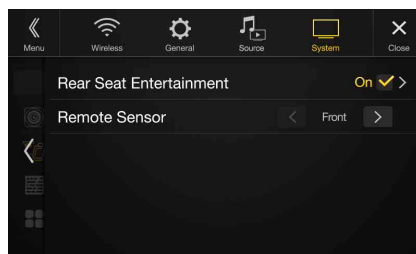

Setting item:

Remote Sensor

Setting contents:

Front (Initial setting) / Rear

Front: The remote sensor of this unit is effective.

Rear: The remote sensor of Rear monitor is effective.

- You can also control this setting from the Rear Seat Entertainment System Setup screen. For details, see “Rear Seat Entertainment Function” (page 20).

External Accessories Setup

[External Accessories] is selected on the System Setup Menu screen in step 1. See “System Setup” (page 45).



Setting the External Audio Processor

When using an external audio processor, set to “On” (☑).

Setting item:

External Audio Processor

Setting contents:

Off (Initial setting) / On

- When this setting is “On,” the Volume level is fixed at 10. Also, Balance/Fader/Subwoofer Level/Subwoofer Phase/Bass/Treble/MX HD/EQ Presets/Dual HD EQ/X-Over/Time Correction/Defeat/Phone Speaker/Default Sound Settings are set to “Off” or “Flat” and cannot be adjusted.
- Use the External Audio Processor to adjust volume.

Setting the Additional AUX BOX

When displaying an AUX image in the rear monitor, you need an external AUX distribution box.

When using an external AUX distribution box, set to "On" (☑).

Setting item:

RSE Aux Switch Box

Setting contents:

Off (Initial setting) / On

Setting the HDMI Selector On/Off

If you connect an HDMI selector, you can connect two HDMI devices.

When using an HDMI selector, set to "On" (☑).

Setting item:

HDMI selector

Setting contents:

Off (Initial setting) / On

- For details on switching the HDMI source when two HDMI devices are connected, see "HDMI Operation" (page 78).

Setting the External Accessory Control

When you have connected the optional External Accessory Control module, set this setting to "On" to turn the headlights ON/OFF or adjust the air suspension from this unit.

Setting item:

External Accessory Ctrl

Setting contents:

Off (Initial setting) / On

- When set to "On," the [🚗] (Ext Acc Ctrl) icon is displayed on the Menu screen.
- For details on the External Accessory screen and its operation, see "External Accessory Control Operation" (page 96).

Smartphone Apps Setup

[Smartphone Apps] is selected on the System Setup Menu screen in step 1. See "System Setup" (page 45).

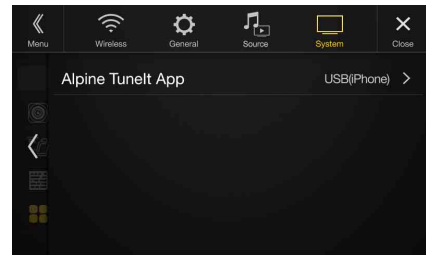

Set Tunelt to USB (iPhone) when an iPhone is connected, or set to Bluetooth (Android) when an Android Smartphone is paired.

Setting item:

Alpine Tunelt App

Setting contents:

Off / USB (iPhone) (Initial setting) / Bluetooth (Android)*

Off: No Smartphone is connected.

USB (iPhone): When an iPhone is connected to the unit's USB port, you can programme the unit's sound tuning parameters, or communicate with SNS.

Bluetooth (Android): Set this when an Android Smartphone is paired with this unit via Bluetooth technology. And after Bluetooth Audio is connected, you can programme the unit's sound tuning parameters, or communicate with SNS.

- Set this setting after closing the Alpine Tunelt App.
- For this function to work properly, specific applications must be installed on your Smartphone before connection. Consult your Alpine dealer or the Alpine website for details.
- Only the iPhone and certain Android Smartphones support this function.

* Not displayed when Bluetooth is set to Off. For details, see "Bluetooth Setup" (page 30)

Radio/HD Radio™/ RBDS

The unit can receive HD Radio signals based on digital radio broadcast standards, in addition to analog radio broadcasts using RBDS. HD Radio signals are broadcast in the service areas of the current AM/FM broadcasters where they provide digital audio distribution and data services. This unit receives the above digital broadcasts for your high-quality sound enjoyment.

Depending on the signal strength in TUNER mode, the unit will automatically switch between digital signals if they can be received, and analog radio using RBDS if digital signals cannot be received. For details, please see “Switching between Digital and Analog,” “Forced Analog Mode.”

- RBDS mode is only available during FM broadcast reception.

This unit is able to receive signals based on the terrestrial digital radio broadcasting standard.

When current AM/FM broadcasters are transmitting digital audio and data services, HD Radio signals are on-the-air in their service area. You can receive their digital broadcast and enjoy high quality sound. If there is no HD Radio signal in the current area, after 10 seconds, this unit will switch to receive the RBDS Radio signal automatically. However, the display is still HD Radio mode screen.

HD Radio main screen example



Function mode

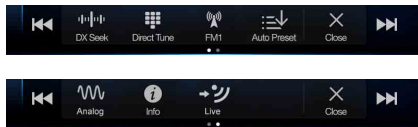

- ① HD Radio Indicator *1
- ② Band display
Displays the band of the signal currently being received.
- ③ Multicast Indicator*2
Lights during multicast reception.

- ④ Info area
RBDS
Station Info. mode:
Program Type /Frequency and PS Name/Artist Name/Song Name/Album Name
Radio Text mode:
Frequency/ Radio Text
 - For details on switching the display of the Radio text, see “Displaying Radio Text (RBDS FM Radio mode only)” (page 53).

- HD Radio
- Station Info. mode:
Short Station Name/Frequency/Artist Name/Song Name/ Album Name
- ⑤ Artwork etc./Station Logo display*1
 - ⑥ Preset mode button
Swipe to the right when you use the Preset mode screen.

*1 HD Radio mode only.

*2 Lights during multicast reception. (Displays the LIVE Indicator when the Ballgame Mode is set to “On”).



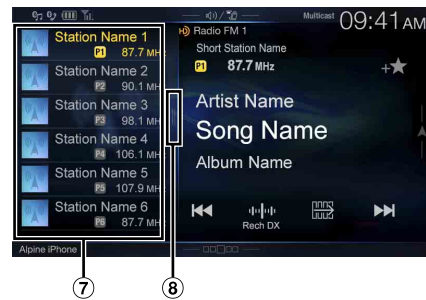

Preset mode screen example









- ⑦ Preset button
Swipe vertically in the list to change pages.
- ⑧ Program Type list button (RBDS FM Radio mode only)
Swipe to the right when you use the Program Type list screen.

Radio Basic Operation







Listening to the Radio

- 1 Press the  (AUDIO) button to select radio mode.**
The display shows the radio mode screen.
 - You can select and change the source from the Menu screen (page 21) or the Favorite screen (page 24).
- 2 Touch .**
The radio band select pop up screen is displayed.
 -  button displays the current selected band. (e.g. [FM1])
- 3 Select the desired band from FM1/FM2/AM.**
- 4 Touch .**
The tuning mode selection popup is displayed.
 -  button displays the current selected mode. (e.g. [DX Seek])
- 5 Touch the desired tuning mode.**
The radio frequency up or down button changes depending on the tuning mode.

DX Seek	Local Seek	D.DX Seek	D.Local Seek
			
Manual	Program Type		
			

 - There are two modes you can select for auto tuning, DX and Local:
 - DX Seek (Distance) mode*;
Both strong and weak stations will be tuned in.
 - Local Seek mode*;
Only strong stations will be tuned in.
The initial setting is DX.
 - D (Digital).DX Seek mode;
Automatically receives a receivable digital broadcast.
 - D (Digital).Local Seek mode;
Automatically receives a strong digital broadcast only.
 - Manual mode;
The frequency is manually tuned in steps
 - Program Type Seek mode (RBDS FM Radio mode only);
The currently selected programme type station will be tuned.
 - During Forced Analog mode, digital broadcasts cannot be received.

* Depending on the signal, a digital or analog broadcast is received.

- 6 Touch ,  or ,  to change the radio frequency up or down respectively.**
In manual mode, touch and hold to change the frequency continuously.
 - The ,  buttons provide the same functions above.

Presetting Stations Manually

- 1 Tune in a desired radio station you wish to store in the preset memory by manual or automatic seek tuning.**
- 2 Touch the Preset number you want to store, for at least 2 seconds.**
The selected station is stored.
- 3 Repeat the procedure to store up to 11 other stations onto the same band.**
To use this procedure for other bands, simply select the desired band and repeat the procedure.
A total of 36 stations can be stored in the preset memory (12 stations for each band; FM1, FM2, or AM).
 - For details on switching to the Preset mode screen, see ⑥ in "HD Radio main screen example" (page 51).
 - If a preset memory has already been set in the same preset number, it will be cleared and the new station will be memorized.

Presetting Stations Automatically



The tuner can automatically seek and store 12 strong stations in the selected band in ascending order of frequency.

Select the desired band then touch and hold (Auto Preset).

- The tuner automatically seeks and stores 12 strong stations into the preset buttons in ascending order of frequency. When automatic storing has completed, the station stored in the preset 1 is selected.
- If no stations are stored, the tuner will return to the original station you were listening to before the automatic storing procedure began.
 - You can cancel this process by touching  (Auto Preset) while the tuner is automatically seeking stations. Canceling will return the tuner preset to the previous setting.

Tuning to Preset Stations

You can tune in the preset stations in memory on either band using its preset number.

- 1 Touch .**
The radio band select pop up screen is displayed.
 -  button displays the current selected band. (e.g. [FM1])
- 2 Select the desired band from FM1/FM2/AM.**
- 3 Touch any one of the Preset numbers you have already stored in the Preset mode screen.**
The preset station is received.
 - For details on switching to the Preset mode screen, see ⑥ in "HD Radio main screen example" (page 51).

Inputting Frequency Directly and Receiving the Radio Station

You can input a frequency of the same band directly and receive the radio station.

1 Touch [] (Direct Tune).

The numeric keypad input mode screen appears.

2 Touch a desired number.

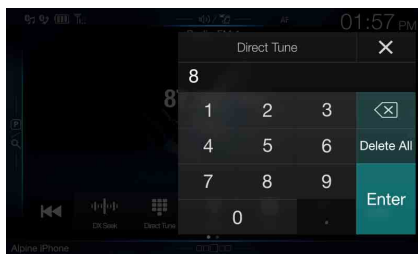

Touch [] to delete an entered number.

Touch [**Delete All**] to delete all entered numbers.

3 Touch [**Enter**] on the numeric keypad mode screen to confirm your selection.

Touch [] to hide the keypad display.

Receiving a Multicast (HD Radio Mode only)

Multicasting is the ability to broadcast multiple program streams over a single FM frequency. This increases the amount and diversity of content choices. A maximum of 8 multicast station channels can be selected on this unit.

- “Multicast” indicator appears when signal reception is possible.
- The station number of the current broadcast station appears behind the frequency (ex. 90.3 MHz-HD5 means there are 5 stations on 90.3 MHz).

Touch [], [] or [], [].

The sub channel of the received radio station is changed.

- If reception is lost during SPS broadcasting due to weak or no signal, the screen will display “HDx Signal loss.”

Selecting the Receivable Program Type (RBDS FM Radio mode only)

You can select and receive the currently receivable stations in the Program Type list screen.

■ Program Type list screen example





- For details on switching to the Program Type list screen, see ⑧ in “Preset mode screen example” (page 51).

Select the desired programme type in the Program Type list screen.

Program Type Seek starts and the receivable programme type is received.



If no Program Type station is found, “No program type available.” will be displayed.

- Touch [] or [] to select the same programme type station as the currently selected programme type after switching the tuning mode to Program Type (Program Type Seek) mode.

Forced Analog Mode

Activate the Compulsory Analog Radio mode to receive only analog radio signals.

Touch [] (Analog).

The [] (Analog) button is highlighted. To cancel Compulsory Analog Radio mode, touch [] (Analog) again.

- During Forced Analog mode, only analog broadcasts will be received even when digital broadcasts become available.

Displaying Radio Text (RBDS FM Radio mode only)

Text messages from a radio station can be displayed.

1 Tune in a radio station that transmits text messages.

2 Touch [] (Info) in the FM radio mode repeatedly to switch to the desired display.

Station Info.Mode → Radio Text Mode → Station Info.Mode

Station Info. Mode

Program Type /Frequency and PS Name/Artist Name/Song Name/Album Name

Radio Text Mode

Frequency/Radio Text

Using Ballgame Mode

In live broadcast, such as sportscasts, etc., a time lag occurs between digital sound and analog sound. Therefore, when live broadcasts are received, a time lag between the real broadcast may occur and the unit can change to analog broadcasting automatically.

Touch [→📶] (LIVE) to switch On/Off.



The LIVE Indicator is displayed when Ballgame Mode is set to “On.”

- When receiving a live broadcast while the Ballgame mode is on, the LIVE indicator is highlighted.

📶LIVE → 📶LIVE (During live broadcast)

About the Feature Logos

Digital Sound

- Digital, CD-quality sound. HD Radio Technology enables local radio stations to broadcast a clean digital signal. AM sounds like today’s FM and FM sounds like a CD.

PSD

- Program Service Data: Contributes to the superior user experience of HD Radio Technology. Presents song name, artist, station IDs, HD2/HD3 Channel Guide, and other relevant data streams.

HD2/HD3

- Adjacent to traditional main stations are extra local FM channels. These HD2/HD3 Channels provide new, original music as well as deep cuts into traditional genre.

Artist Experience

- Visual information related to content being played on your HD Radio receiver, such as Album Art, historical photographs, still art from live broadcasts, among other related content.

USB Flash drive (Optional)

You can play back music files (MP3/WMA/AAC/FLAC) stored in a USB flash drive on the internal player of this system.

■ USB Audio main screen example

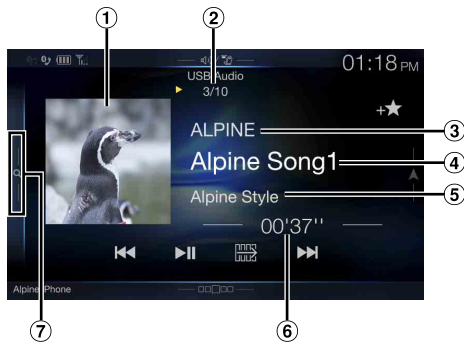

Function mode



- ① Artwork display
 - You can change the artwork position. For details, see “Switching the Artwork Position” (page 40).
- ② Current track no./Total song no.
- ③ Artist title
- ④ Song title
- ⑤ Album title
- ⑥ Elapsed time
- ⑦ Quick Search button
Touch or swipe to the right to use the Quick Search mode.

■ Quick Search mode screen example

Swipe vertically in the list to change pages.

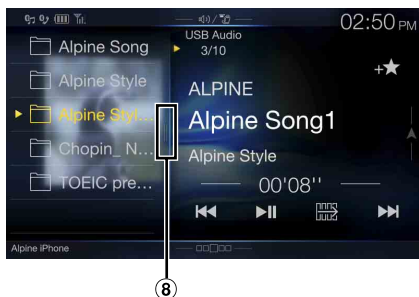

- ⑧ Full Search mode button
Swipe to the right when you use the Full Search mode screen.

Playback

- 1 Press the **AUDIO** button to select USB mode.
The display shows the USB mode screen.
 - You can select and change the source in the Menu screen (page 21) or Favorite screen (page 24).

- 2 Touch [**◀◀**] or [**▶▶**] or to select the desired track (file).

Returning to the beginning of the current (or previous) track (file):
Touch [**◀◀**].

Fast reverse:
Touch and hold [**◀◀**].

Advancing to the beginning of the next track (file):
Touch [**▶▶**].

Fast forward:
Touch and hold [**▶▶**].

- The **◀◀**, **▶▶** buttons provide the same functions above.

- 3 To pause playback, touch [**▢**].
Touching [**▢**] again will resume playback.
During playback, the [**▢**] indicator is displayed in Audio main screen. During a pause, the [**▢▢▢**] indicator is displayed in the Audio main screen.

- The playback time may not be correctly displayed when a VBR (Variable Bit Rate) recorded file is played back.
- If there is tag information, artist name/album name/track name is displayed.
- ID3 tag/WMA tag
If an MP3/WMA/AAC/FLAC file contains ID3 tag/WMA tag information, the ID3 tag/WMA tag information is displayed. (e.g., song name, artist name, and album name)

Repeat Play

- 1 Touch [**↺**].
The Repeat mode select pop up screen is displayed.
 - The [**↺**] button displays the currently selected mode.

- 2 Select your desired Repeat mode.
 - Folder **↺**: Only files in a folder are repeatedly played back.
 - File **↺**: Only the file currently playing is repeatedly played back.
 - OFF **↺**: Repeat mode Off.





Random Play

1 Touch [🔀].

The Random Play mode select pop up screen is displayed.

- The [🔀] button displays the currently selected mode.

2 Select your desired Random Play mode.

- ALL : All songs in the USB flash drive are played back in random sequence. Any one song does not play back again until all songs have been played back.
- Folder : A Folder is selected randomly and songs in the Folder are played back in order. After all songs are played in a Folder, the next Folder is selected randomly.
- File : All songs in the Folder (Folder/File) including the song currently being played are played back in random sequence.
- OFF : Random mode Off.

- If the Random Play mode is activated during Repeat playback, the Repeat Play mode will be canceled.
- If you select a track by using the search mode, the Random Play mode will be canceled.

Searching for a Desired Song

You can search for your desired song by using one of two modes; the Quick Search mode and the Full Search mode.

Quick Search mode

Touch your desired Folder name or File name.

The selected Folder*¹ or File is played.

*¹ The first file in the selected folder is played back.

- For details on switching to the Quick Search mode, see ⑦ in “USB Audio main screen example” (page 55).

Full Search mode

Touch your desired Folder name*² or File name.

When you select a File name, the selected song is played.

When you select a Folder name, repeat the same procedure to select another Folder name or File name.

*² When you touch the [▶] by a Folder name, the unit plays from the first song in the Folder.

- For details on switching to the Full Search mode, see ⑧ in “Quick Search mode screen example” (page 55).
- To switch the displayed list or return to the previous page in the Full Search mode, see “About Basic Operation for List Screen” (page 18).

iPod/iPhone (Optional)

A separately sold USB iPod/iPhone AV cable (KCU-461iV) or a separately sold Lightning to USB cable (KCU-471i) is required depending on the type of iPod/iPhone.

When the unit is connected by the above cable, the controls on the iPod are disabled.

- If no sound is output when you connect an iPhone with a “Set Bluetooth Device” setting of both “Hands-free” and “Bluetooth Audio” to the unit’s USB port and change the Audio source from Bluetooth Audio, set “Alpine TuneIt App” to “USB (iPhone)” or “Off.” For more details, see “Registering the Bluetooth Device” (page 30) and “Smartphone Apps Setup” (page 50).
- This unit does not support video playback from iPhone 5, etc., which uses Apple’s Lightning Connector.
- Internet or telephone functions, etc., of the iPhone or iPod touch are not controllable from the unit, but these functions can be controlled using the iPhone or iPod touch itself.
- To watch the video screen of the file in the iPod/iPhone, the parking brake must be engaged.
- For automatic transmission vehicles, place the transmission lever in the Park position.

About iPod Video mode (X108U/INE-W967HD only)

- When the iDataLink module (sold separately) is connected, the iPod Video mode is not available.

About iPod/iPhone models usable with this unit

- The following devices have been tested and shown to work with this unit. Correct function of earlier versions cannot be guaranteed.
 - iPod touch 5th generation 32GB/64GB: Ver.8.1.1
 - iPod touch 4th generation 8GB/32GB/64GB: Ver.6.1.3
 - iPod touch 3rd generation 32GB/64GB: Ver.5.1.1
 - iPod touch 2nd generation 8GB/16GB/32GB: Ver.4.2.1
 - iPod touch 1st generation 8GB/16GB/32GB: Ver.3.1.3
 - iPod nano 7th generation 16GB: Ver.1.0.2
 - iPod nano 6th generation 8GB/16GB: Ver.1.2
 - iPod nano 5th generation (video camera) 8GB/16GB: Ver.1.0.2
 - iPod nano 4th generation (video) 8GB/16GB: Ver.1.0.4
 - iPod nano 3rd generation (video) 4GB/8GB: Ver.1.1.3
 - iPod classic (Late2009) 160GB: Ver.2.0.4
 - iPod classic 120GB: Ver.2.0.1
 - iPod classic 80GB/160GB: Ver.1.1.2
- The following devices have been tested and shown to work with this unit. Correct function of earlier versions cannot be guaranteed.
 - iPhone 6 Plus 16GB/64GB/128GB: Ver.8.1.1
 - iPhone 6 6GB/64GB/128GB: Ver.8.1.1
 - iPhone 5S 16GB/32GB/64GB: Ver.8.1.1
 - iPhone 5C 16GB/32GB/64GB: Ver.8.1.1
 - iPhone 5 16GB/32GB/64GB: Ver.8.1.1
 - iPhone 4S 16GB/32GB/64GB: Ver.8.1.1
 - iPhone 4 16GB/32GB: Ver.7.1.2
 - iPhone 3GS 8GB/16GB/32GB: Ver.6.1.3
 - iPhone 3G 8GB/16GB: Ver.4.2.1
 - iPhone 4GB/8GB/16GB: Ver.3.1.3
- For clarity in identifying your model of iPod, please see Apple’s own document “Identifying iPod models” at <http://support.apple.com/kb/HT1353>.

⚠ WARNING

It is dangerous for the driver to watch video while driving the vehicle. The driver may be distracted from looking ahead and an accident could occur.

Install the unit correctly so that the driver cannot watch a video unless the car is stopped and the parking brake is applied.

If the unit is not installed correctly, the driver will be able to watch a video while driving and may be distracted from looking ahead and cause an accident. The driver or other people could be severely injured.

■ iPod/iPhone main screen example

Audio mode



Function mode

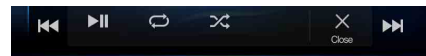

Video mode

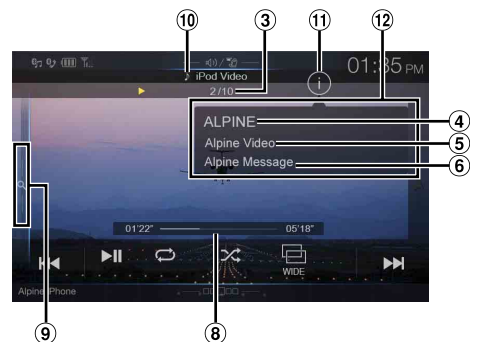

- ① Artwork display
 - You can change the artwork position. For details, see “Switching the Artwork Position” (page 40).
- ② : During audio-only playback of a video file in a Playlist, the Video icon is displayed.
- ③ Current song no./Total song no.

- ④ Artist title/Release Date*
- ⑤ Song title/Episode title*
- ⑥ Album title/Podcast title*
- ⑦ Total time for playing
- ⑧ Elapsed time
- ⑨ Quick Search button
- Touch or swipe to the right when using Quick Search mode.
- ⑩ : During audio-only playback of a music file in a video Playlist, the Music icon is displayed.
- ⑪ Info mode switching button (Video mode only)
- ⑫ Info mode display

* Podcast mode.

■ Quick Search mode screen example

Swipe vertically in the list to change pages.

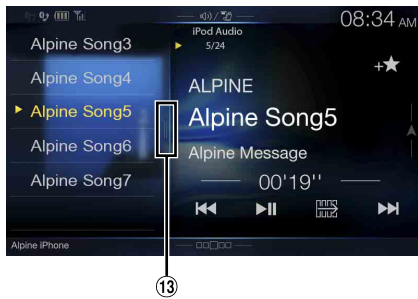

- ⑬ Full Search button
- Swipe to the right when using Full Search mode.

The iPod/iPhone operation screen display during video file playback

Touch the screen while the iPod/iPhone playback screen is displayed.

The iPod/iPhone operation screen is displayed.

- The operation screen changes to the visual screen in the iPod mode for 5 seconds after an operation has been performed.
- For your safety, video is not displayed and only audio can be heard while driving.

Playback

1 Press the (AUDIO) button to select iPod mode.

The display shows the iPod mode screen.

- You can select and change the source in the Menu screen (page 21) or Favorite screen (page 24).

2 Touch [] or [] or to select the desired track (file).

Returning to the beginning of the current (or previous) track (file):

Touch [].

Fast reverse the current track :

Touch and hold [].

Advancing to the beginning of the next track (file) :

Touch [].

Fast forward the current track :

Touch and hold [].

- The , buttons provide the same functions above.

3 To pause playback, touch [/III].

- If a song is playing on the iPod/iPhone before it is connected to the unit, it will continue playing when it is connected.
- An episode may have several chapters. The chapter can be changed by touching [] or [].
- If the artist, album or song name, created in iTunes, has too many characters, songs may not be played back when connected to the unit. Therefore, a maximum of 64 characters is recommended. The maximum number of characters for the unit is 64.
- Some characters may not be correctly displayed.

Searching for a Music File

An iPod/iPhone can contain thousands of songs. For this reason, this unit can make various searches using the search function as shown below.

Using the Playlist/Artist/Album/Podcast/Audiobook/Genre/Composer/Song search mode's individual hierarchy, you can narrow down your search as shown in the table below.

<MUSIC Search Menu>

Hierarchy 1	Hierarchy 2	Hierarchy 3	Hierarchy 4
Playlists	Songs	—	—
Artists	Albums	Songs	—
Albums	Songs	—	—
Songs	—	—	—
Podcasts	Episodes	—	—
Genres	Artists	Albums	Songs
Composers	Albums	Songs	—
Audiobooks	—	—	—

Quick Search Mode

In Quick Search mode, the list from the previous search mode is displayed. For example, if the last time you searched for songs was in Albums, the Album list is displayed. If you have not used the search mode, the list is not displayed in the Quick Search mode. In this case, go to the Full Search mode.

In Quick Search mode, touch the desired list (for example, Album list).

The selected Album is played.

- To switch into Quick Search mode, see ⑨ in "iPod/iPhone main screen example" (page 57).
- To search within an Album, go to the Full Search mode.

Full Search Mode

For example: Searching by Artist name

The following example explains how an Artists search is performed. Another search mode can be used for the same operation, although the hierarchy differs.

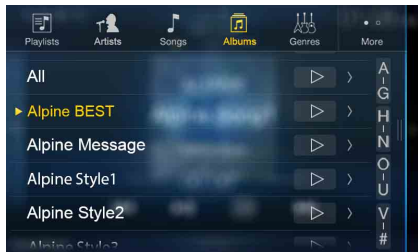

1 Touch [Artists] in the Full Search mode screen.

The Artists search screen is displayed.

- To switch into Full Search mode, see ⑬ in “Quick Search mode screen example” (page 58).

2 Select the desired artist.

To play back the Artist directly

- Touch [▶] of the artist's name.
All songs of the selected artist are played back.

To search for the Album of the Artist

- Touch the selected artist name.
The Albums search screen of the selected artist is displayed.
- Touch [▶] of the desired album's name.
All songs of the selected album are played back.

To search for a Song in the Album of the Artist

- Touch the desired artist's name.
All albums of the selected artist are displayed.

3 Touch the desired album's name.

All songs of the selected album are displayed.

4 Touch the desired song's name.

The selected song is played back.

- Touching [▶] of “All” will play back all songs in the list.
- Touching “All” will display the search list in the next hierarchy.
- An alphabet skip function is available. See “Alphabet Search Function” (page 59).
- To switch the displayed list or return to the previous page in the Full Search mode, see “About Basic Operation for List Screen” (page 18).

Searching for a Desired Video File

You can select a movie, music video, etc., from the list screen.

- Video search mode depends on the iPod/iPhone. If the specification of the iPod/iPhone is changed, the search mode on this unit will also be changed.

Examples for the video search mode

- Video Playlists
- Movies
- Music Videos, etc.

For example: Searching by Movie

The following example explains how a Movie search is performed. Another search mode can be used for the same operation, although the hierarchy differs.

1 Touch the [Video] icon in the Full Search mode screen.

The Video search screen is displayed.

- To switch into Full Search mode, see ⑬ in “Quick Search mode screen example” (page 58).
- If the Video icon is not displayed, touch [More] to change the Search mode.

2 Touch [Movies].

The Movies search screen is displayed.

3 Touch the desired movie.

The selected movie is played back.

Alphabet Search Function

The unit is provided with an alphabet search function for effective searching. When you use this function in the search mode, you can quickly search an artist or a song, etc.

This is an example of how to search Artist Name for names beginning with “R”.

1 Touch “O-U” of the alphabet group.

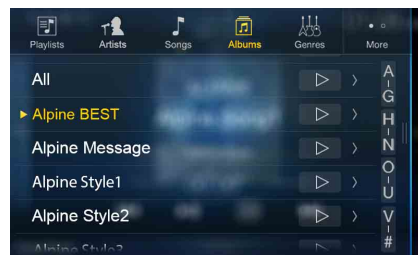

“O P Q R S T U” of the alphabet group “O - U” is displayed.

2 Touch “R” you want to search.

Artist names beginning with “R” are displayed.

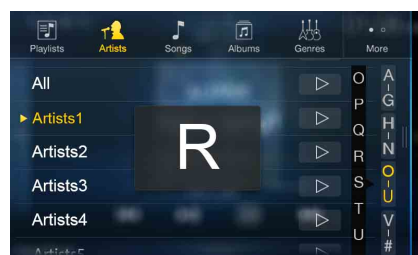

3 Touch your desired artist name.

- If there are no names in the list beginning with that letter, the next letter of the alphabet is searched.

For example: If there are no names beginning with “R,” the search list begins with “S.”

Repeat Play

Touch [🔄] to repeatedly play back the currently track.

The tracks (files) will be played repeatedly.

Touch [🔄] again to deactivate Repeat play.

Track Repeat 🔄 → OFF 🔄 → Track Repeat 🔄

Random Play (Shuffle)

1 Touch [🔀].

The Random Play mode select pop up screen is displayed.

- The [🔀] button displays the currently selected mode.

2 Select your desired Random Play mode.

The selected Random Play mode changes the button.

Song 🔀: All files in the iPod are played back in random sequence.

Album 🔀: The songs on each album are played back in proper order. Upon completing of all the songs on the album, the next album is selected randomly. This continues until all albums have been played.

Songs 🔀: Song shuffle randomly plays back songs within a selected category (playlist, album, etc.). The songs within the category are played just once until all songs have been played.

OFF 🔀: Random mode Off.

Switching Display Modes (During Video File Play Back)

You can switch the Display Mode while playing a Video File.

1 Touch [📺].

The Display Mode select pop up screen is displayed.

- The [📺] button displays the currently selected mode. (e.g. [Normal])
- You cannot operate them while driving.

2 Select your desired Display Mode.

Wide mode



In Wide mode, the monitor displays a normal picture wider to fit in a wide-screen monitor by evenly stretching out the picture horizontally.

Cinema mode

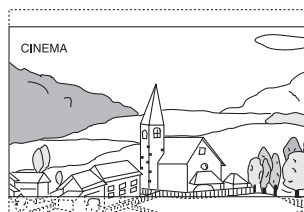

In Cinema mode, the monitor displays a normal picture by stretching out the picture horizontally and vertically. This mode is good for displaying a cinema type picture at the 16:9 ratio.

Normal mode

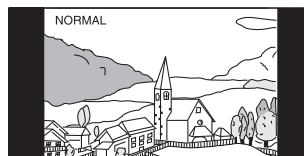

In Normal mode, the monitor displays a normal picture at the center of the screen with a vertical black band at each side.

Pandora® internet radio (optional)

Pandora® internet radio is your own FREE personalized radio now available to stream music on your Smartphone (which runs Android OS, iOS or BlackBerry OS).

Just start with the name of one of your favorite artists, songs or classical composers and Pandora® will create a “station” that plays their music and more music like it.

The unit enables you to interact with your Pandora® account by connecting an iPhone and smartphone that has the latest version of the Pandora® application installed.

- If no sound is output when you connect an iPhone with a “Set Bluetooth Device” setting of both “Hands-free” and “Bluetooth Audio” to the unit’s USB port and change the Audio source from Bluetooth Audio, set “Alpine TuneIt App” to “USB (iPhone)” or “Off.” For more details, see “Registering the Bluetooth Device” (page 30) and “Smartphone Apps Setup” (page 50).

■ iPhone Pandora main screen example

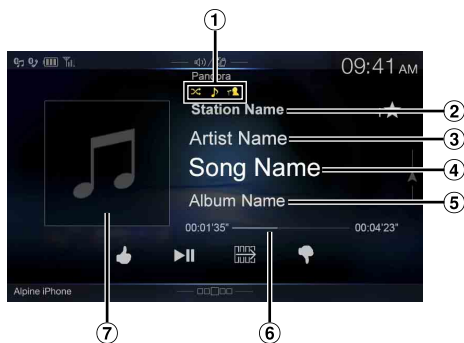

Function mode

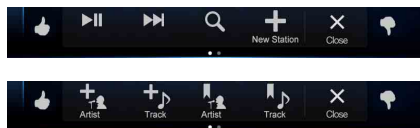

■ Bluetooth Pandora main screen example



Function mode

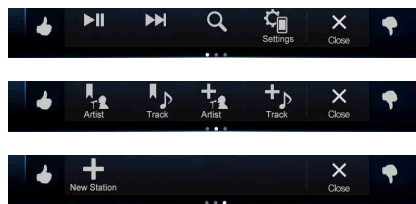

- ① Track/Artist bookmark icon/QuickMix indicator
- ② Station name
- ③ Artist Name
- ④ Song Name
- ⑤ Album Name
- ⑥ Playing time
- ⑦ Artwork display

Listening to Pandora®

1 Launch the Pandora® on the smartphone.

2 Press the (AUDIO) button to select Pandora® or Bluetooth Pandora® mode.

The display shows the Pandora mode screen.

- You can select and change the source in the Menu screen (page 21) or Favorites screen (page 24).

3 To pause playback, touch [/||].

4 To skip to the next song, touch [].

- The operation to replay a previous song is not available.
- Pandora® limits the number of skips allowed on their service. If you attempt to skip songs beyond the limit, “You’ve reached your skip limit.” is displayed.
- Even if you reconnect an iPhone without launching Pandora Application while the power is off, Pandora mode (not iPod mode) is displayed when power is turned back on.
- Depending on the signal status, song may be stopped during playback.
- While receiving an advertisement, you cannot operate any buttons other than [/||] (play/pause) and [] (Search).
- The playback time may not be correctly displayed.
- The display content varies when ads are received.

“Thumbs” Feedback

You can personalize your stations with “Thumbs Up” or “Thumbs Down” feedback, which the system takes into account for future music selections.

During playback, touch [👍] for thumbs up, or touch [👎] for thumbs down.

- 👍: The “👍” indicator appears in the display. Pandora® will add similar music to your station.
- 👎: The “👎” indicator is displayed. Pandora® will ban that song from your station, and the current song is skipped. If the number of skips allowed has reached its limit, the current song continues to play back.

- In some situations, “Thumbs” feedback may not be available.

Searching for a Desired Station

You can display your station list and select stations directly from the unit.

1 Touch [🔍] (Search) to activate the Search mode.

Alphabet Search

2 Touch [By A-Z].

The “By A-Z” search mode is activated and the station names are listed alphabetically.

3 Touch the desired station.

Pandora will play that station.

Search by Date Added

2 Touch [By Date].

The “By Date” search mode is activated and the station names are listed by the date they were added to the account.

3 Touch the desired station.

Pandora will play that station.

QuickMix

Use QuickMix to create a playlist based on two or more of your Pandora stations. Edit your QuickMix station selections on the Pandora Compatible Application for iPhone when it is not connected to the unit.

1 Touch [🔍] (Search) to activate the Search mode.

The “By A-Z” or “By Date” search mode is activated and the station name is displayed.

2 Touch [🔀] (QuickMix).

- The 🔀 indicator lights, and the songs from the created stations are played back in random sequence.

Creating a New Station

Basing on the currently playing song or artist, a personalized Pandora station can be created. The new station will play more music like it.

Free word

1 During playback, touch [➕] (New Station).

The Key Pad screen is displayed. You can enter a keyword and search for Artist/Song.

2 Enter a keyword and touch [OK].

3 Touch the desired list.

The new station is automatically applied.

- For details of how to input characters from the keypad, refer to “How to Input Characters and Numbers (Keypad)” (page 23).
- You cannot operate them while driving.

Artist/Track

During playback, touch [👤] (Artist) or [🎵] (Track).

- The created station is saved to your station list.
- When the Smartphone is not connected to this unit, you can create personalized Pandora® stations using the Pandora® Application on your Smartphone. You can also create stations on the web at www.pandora.com.
- In some situations, creating a new station may not be available.
- You cannot perform this operation while driving.

Bookmarking a Desired Track or Artist

The currently playing song or artist can be bookmarked and saved to your Pandora account.

During playback, touch [👤] (Artist) or [🎵] (Track).

The current track or artist is bookmarked. “🎵” icon or “👤” icon is displayed.

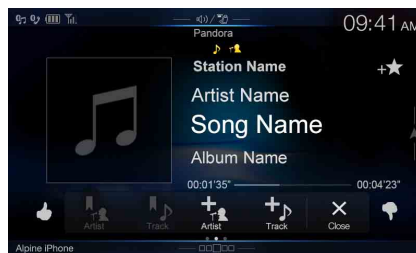

- Your bookmarks can be viewed on your “Profile” page at www.pandora.com.
- In some situations, bookmarks may not be available.

Connecting a Bluetooth Device (Bluetooth Pandora® Only)

Registering a Bluetooth device in the unit enables automatic connection. If it does not connect automatically, run through the connection procedure again.



- 1 Touch [] (Settings).**
The Device Setting select pop up screen is displayed.
- 2 Touch [Reconnect].**
Bluetooth connection will start.

Disconnecting the Bluetooth Connection

- 1 Touch [] (Settings).**
The Device Setting select pop up screen is displayed.
- 2 Touch [Disconnect].**
The Bluetooth connection is disconnected.

Changing the connecting Bluetooth Device

If multiple Bluetooth devices are registered in this device, you can change the connection among the registered devices.

- 1 Touch [] (Settings).**
- 2 Touch [Change].**
- 3 Touch [] (Audio) or [] (Hands-free) of the selected device.**
The connection will transfer to the selected device.

SiriusXM Satellite Radio Operation (Optional)

SiriusXM Tuner operation:

When an optional SiriusXM Tuner is connected to this unit, the following operations may be performed.

■ SiriusXM main screen example (Song Info. Mode)



Function mode

The Function mode switch is different depending on Tune Start mode and Replay mode.

< When Tune Start mode is not available >



< When Tune Start mode is available >



< During Replay mode >

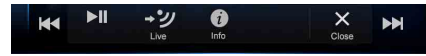

- ① Signal Indicator
Indicates the signal strength of SiriusXM.
- ② Info area
Station Info. Mode*:
Channel No/Long Channel Name/Category Name
Song Info.Mode:
Artist Name/Song Name/Album Name
- ③ Album Art
The image that corresponds with the channel currently being received is displayed.
 - You can change the artwork position. For details, see "Switching the Artwork Position" (page 40).
- ④ Preset mode button
Touch or swipe to the right when you use the Preset mode screen.

* In Station Info. Mode, the Channel logo currently being received is displayed on the left side of the Long Channel Name.

■ Preset mode screen example



- ⑤ Preset button
Swipe vertically in the list to change pages.
- ⑥ Search mode button
Swipe to the right when you use the Search mode screen.



Receiving Channels with the SiriusXM Tuner

About SiriusXM Satellite Radio

Everything worth listening to is on SiriusXM, getting over 130 channels, including the most commercial-free music, plus the best sports, news, talk and entertainment. A SiriusXM Tuner and Subscription are required. For more information, visit www.siriusxm.com/activatenow, or call 1-866-635-2349.

To activate SiriusXM Canada service, go www.xmradio.ca and click on "ACTIVATE RADIO" in the top right corner, or call 1-877-438-9677.

- The SiriusXM Satellite Radio controls on this unit are available only when a SiriusXM Tuner is connected.

- 1 Press the  (AUDIO) button to select SiriusXM mode.**
The display shows the SiriusXM mode screen.
 - You can select and change the source in the Menu screen (page 21) or Favorites screen (page 24).
- 2 Touch [] or [] to select the desired channel. Touching and holding either button will rapidly browse through the channels.**
 - Refer to the SiriusXM Tuner User Guide for details on how to install the SiriusXM Tuner.



Tuning Channels by Category

Channels are grouped into categories based on the type of content heard on the channels.

- 1 Touch [] (Category) on the SiriusXM main screen to activate the category browsing mode.**
The channels within the category of the current channel are listed.

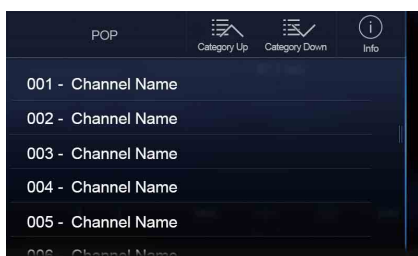
■ Category browsing mode screen example



- Touching [] (Info) changes the display of information for the channels in the category with the following three options.
Channel No./Channel Name → Channel No./Artist Name → Channel No./Song Title → Channel No./Content Info → Channel No./ Channel Name
- 2 Touch [] (Category Up) or [] (Category Down) on the category browsing mode screen to select a desired category.**
The Category Name is shown at the top of the display.
 - 3 Select the desired channel.**
 - If no operation is performed for 10 seconds, the category browsing mode is canceled.

Changing the Display



Text information, such as the channel name, artist name/feature, and song/program title, is available with SiriusXM or channel. The unit can display this text information as explained below.

Touch [] (Info).

Each time you touch this button, the Station Info. mode and the Song Info. mode switch alternately. For displayed contents, see "SiriusXM main screen example (Song Info. Mode)" (page 64).

Checking the SiriusXM Radio ID Number

To subscribe to the SiriusXM Satellite Radio service, it is necessary to locate and identify the Radio ID of your SiriusXM Tuner. You can check the Radio ID on the bottom surface of the SiriusXM Tuner box. You can also check it from this unit by performing the following procedure.

- 1 While receiving SiriusXM Radio, touch [] or [] to select channel "0".**
The unit displays the ID number.
- 2 To cancel the ID number display, change the channel other than "0".**
 - The SiriusXM Radio ID does not contain the letters I, O, S, or F.

Storing Channel Presets

You can store 18 of your favorite SiriusXM channels for easy recall with Preset buttons.

- 1 Touch the Preset number you want to store, for at least 2 seconds.**
The selected channel is stored.
- 2 Repeat the procedure to store up to 17 other channels.**
A total of 18 channels can be stored in the preset memory.
 - For details on switching to the SiriusXM main screen, see ④ in "SiriusXM main screen example (Song Info. Mode)" (page 64).
 - If you store a new channel into a preset which already has a channel assigned, the current channel will be cleared and replaced with the new one.

Tuning Channels using Presets

Touch any one of the Preset numbers you have already stored in the Preset mode screen.

The preset station is received.

- For details on switching to the SiriusXM main screen, see ④ in "SiriusXM main screen example (Song Info. Mode)" (page 64).

Tune Start Function

Use Tune Start to play music content from its beginning on programmed preset stations. The user can, therefore, enjoy the full track (i.e. song) rather than hearing what's left from its current live playback position.

1 Touch and hold [⏮] (Tune Start) for at least 2 seconds to activate or deactivate the Tune Start function.

When the Tune Start function is activated, [⏮] (Tune Start) is highlighted.

2 On the Preset Mode screen, touch the Preset number.

Tune Start mode will begin.

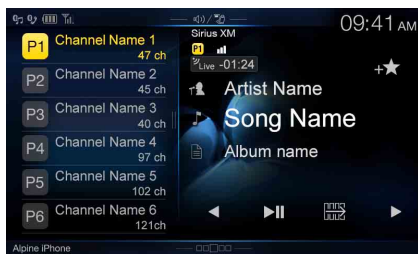

During Tune Start mode, the difference between the "Live -01:24" indicator and the current time is displayed.

- To switch to the Preset mode screen, see ④ in "SiriusXM main screen example (Song Info. Mode)" (page 64).
- The number of preset channels that Tune Start can access differs depending on the SiriusXM Tuner Box.
- Touching [▶▶] (Track Up) or [◀◀] (Track Down) will move a track up/down.
- To fast reverse, touch and hold [◀◀] (Track Down) and to fast forward, touch and hold [▶▶] (Track Up).
- When you touch [→🎵] (Live) or [⏮] (Tune Start) during Tune Start, the program currently selected in Tune Start mode changes to the program currently being broadcast.
- This function is available only when SiriusXM Tuner-SXV200 is connected or later is connected. When Tuner-SXV200 is connected, this function is available only for Preset channels 1-6. When Tuner-SXV300 is connected, this function is available for all Preset channels.
- Preset stations that play other than music-type content will start playing the channel from the current live play point when selected.

Tune Scan Function

While listening to SiriusXM Satellite Radio, you can scan through all the songs you missed from your current band of preset channels.

1 Touch [⏮] (Tune Scan).

The [⏮] (Tune Scan) highlighted during Tune Scan mode.

2 Touch [⏮] (Tune Scan) during scan playback, tune scan mode will be canceled and the selected track will be played back normally.

Touch and hold [⏮] (Tune Scan) for at least 2 seconds during scan playback to cancel Tune Scan mode. The tuner returns to the channel before Tune Scan was initiated.

- Touch [◀] or [▶] during Tune scan mode to switch the Preset channel that Tune Scan is accessing.
- This function is available when SiriusXM Tuner-SXV200 is connected or later is connected. When Tuner-SXV200 is connected, this function is available only for Preset channels 1-6. When Tuner-SXV300 is connected, this function is available for all Preset channels.
- If no operation is performed during the scanning process, when scanning finishes, the next mode depends on the SiriusXM Tuner.

- During Tune Scan mode, the artist and song name will be displayed.
- The SiriusXM Tune scans through the songs from the preset music channels on the current band only, scanning from oldest to newest.
- The number of Preset channels and the play times that can perform Tune Scan differ depending on the SiriusXM Tuner box.

Search Function

1 Touch the ⑥ Search mode button on the Preset mode screen.

The Search list screen appears.

- To switch into Search mode, see ⑥ in "Preset mode screen example" (page 64).

Search item:

All Channels / Category Name*1 / My Music / My Games / Featured*2

*1 The Category name for the channel currently being received is displayed.

*2 Displayed only when the SiriusXM Tuner-SXV200 is connected.

- You can switch the category by touching [⏮] (Category Up) or [⏭] (Category Down) on the List screen after selecting a Search item other than Featured.
- You can switch the display format by touching [i] (Info) in the List screen after selecting a Search item.
Channel No./Channel Name → Channel No./Artist Name → Channel No./Song Title → Channel No./Content Info → Channel No./Channel Name

Searching by Channel

2 Touch [All Channels].

All Channels will be displayed in a list.

3 Touch the selected channel.

Searching by Category

2 Touch Category Name.

The channels within the category of the current channel are listed.

3 Touch the selected channel.

The channel you selected is received.

Searching by My Music

2 Touch [My Music]*.

The artist names and song titles that you have stored and are currently playing will be displayed in a list.

* Displayed only when the stored song or artist is broadcasting.

3 Touch the desired artist/song.

The channel of the selected artist/song being broadcast is received.

Searching by My Games

2 Touch [My Games]*.

The sport teams that you have stored and the game is currently broadcasting will be displayed in a list.

* Displayed only when the game of stored team is broadcasting.

3 Touch the desired team.

The channel of the selected game being broadcast is received.

Searching by Featured Favorites

- 1 Touch [Featured]*.**
The Category that SiriusXM recommends will be displayed in a list.
** Displayed only when the SiriusXM Tuner-SXV200 is connected.*
- 2 Touch the desired category.**
- 3 Touch the desired channel within the selected category.**

Selecting the Channel Directly

You can directly select the channel number on the display of the numeric keypad.

- 1 Touch [] (Direct Tune).**
The numeric keypad input screen is displayed.
- 2 Touch to input the channel number.**
- 3 Touch [Enter].**
The selected channel is received.

Storing the desired Song/Artist

While listening to SiriusXM Satellite Radio, you can be alerted when your favorite songs or artists are playing on other channels. An interruption Alert will be displayed when a matching artist or song is found on another channel. For receiving interruption Alert information, see "Receiving and Tuning to an Alert".

- 1 Touch [] (Set Alert) for at least 2 seconds on the SiriusXM mode screen.**
The Memory type selection screen is displayed.
- 2 Touch the "Artist Saved" or "Song Saved" to select the store type.**
Scrolling text of the Artist's name (Song Title), Total registrations, and Remaining number of registration slots is displayed for 2 seconds, then the Artist or Song is registered as an Artist alert or Song alert.
 - The maximum number of registered Teams, Artists, and Songs is 50. For details on how to register a Favorite Team, see "Setting the Favorite Sports Team Alerts" (page 43).
 - "Artist /Song Unavailable" appears on the display if both the artist and song is not available to be stored.
 - "Artist (Song) Unavailable" is displayed if just the artist (song) is not available to be stored.
"Artist (Song) Saved" is displayed if this Artist (Song) was previously stored.
 - If there is no memory space, "Alert Memory Full" is displayed, and then you are asked whether you want to replace a stored item. If you select "OK," then the list of stored alert items is displayed. Touch the item that you want to replace.

Receiving and Tuning to an Alert

Whenever a stored sports team, artist, or song is playing on another channel, an interruption Alert appears on the unit display. To tune to the game, artist or song identified by the alert, follow the steps below:

- 1 When stored information is broadcast, after displaying "Song Alert", "Artist Alert" or "Game Alert," the screen changes to My Music list*1 or My Games list*2 display.**
**1 Only for Song Alert and Artist Alert.
2 Only for Game Alert.

- 2 Touch the channel on the list you want to receive.**
The display changes to the selected channel and the channel is received.

- Touch [] (Info) on the My Music list/My Games list screen, the information of the broadcasting channels will be changed. Each time you touch the [] (Info), the display changes as below.
My Music list (Artist Alert):
Artist name → Song Title → Channel name → Artist name
My Music List (Song Alert):
Song Title → Channel Name → Artist Name → Song Title
My Games list:
League Short Name/Team Abbrev/Team Nickname → Channel name
→ League Short Name/Team Abbrev/Team Nickname

Replay Function

In SiriusXM mode, you can pause, rewind and replay of live Satellite Radio.

■ Replay mode screen example



- ① Buffer usage
- ② Current Replay point
- ③ Replay status indicator (|| or ►)
- ④ Replay range
- ⑤ Time to live

- 1 Touch [] (Pause) to Pause playing of the channel content.**
The "|| (Pause)" indicator and replay progress bar is displayed.
- 2 Touch [] (Play) again to resume playing the content.**
The "► (Play)" indicator lights up and offset playback commences.

3 Touch [■] to exit Instant Replay and listen to live content.

- To fast reverse, touch and hold [⏮] and to fast forward, touch and hold [⏭].
- Touching [⏮] or [⏭] will move a track up/down.
- If you change channels while in Replay mode, the contents of the replay buffer are emptied.
- The allowed recording time differs depending on the SiriusXM Tuner box.

Parental Lock Function

This function can help restrict the listening of channels to children of appropriate age levels only. For information on setting the Parental Control passcode, see “Setting the Parental Lock” (page 43).
When a locked channel is selected, “Channel <xxx> Locked” is displayed and then the numeric keypad appears for you to enter the passcode.

Input the 4-digit passcode you set in “Setting the Parental Lock” (page 43).

The initial number is 0000.

- If you input a wrong passcode, “Incorrect Pass Code entered” is displayed.
- After entering the correct passcode, you can access all locked channels without entering the passcode again until the unit is powered off and then back on.

Using Jump Memory and Jump Recall function

The Jump Channel is a special channel that you can jump to with the press of a dedicated button and then jump back to the previous channel. This channel is often used to select your favorite SiriusXM traffic and weather report channel.

1 To store the Jump channel in memory, touch and hold [➡] (Jump) for at least 2 seconds.

2 Touch [➡] (Jump) to recall and tune to the saved Jump channel.

3 Touch [➡] (Jump) again to receive the previous channel.

- While receiving the Jump channel, you cannot perform other operations.
- Only one channel can be stored as the jump source channel. When you want to store a new channel, the old channel will be cleared and the new one will be memorized.

HDMI Device (X110 only)

For X108U/INE-W967HD, when you connect an optional DVE-5300 (DVD Player), you can operate it from the unit.

When making HDMI connections, you need to set HDMI on the unit suitable for the connected device. For details, see “HDMI Setup” (page 45).

For details on how to operate the DVD player, see “DVD Player Operation” (page 69).

For details on how to operate iPhones and Smartphones, see “HDMI Operation” (page 78).

About HDMI selector (Optional)

HDMI selector is used when you add HDMI devices (iPhone or other Smartphones).

If you connect an HDMI selector, you can connect one HDMI device for X110 and up to 2 HDMI devices including the optional DVE-5300 (DVD Player) for X108U/INE-W967HD.

- Set “Setting the HDMI Selector On/Off” (page 50) to “On” when using the HDMI selector.
- For details on how to switch the HDMI source by using the HDMI selector, see “Switching the source when two HDMI devices are connected” (page 78).

DVD Player Operation

You can also operate the DVD player using the Remote Control unit supplied with X110. (For X108U/INE-W967HD, supplied with the DVE-5300) For detailed notes on handling and operating the Remote Control unit, see “About Remote Control Operation (X110 only)” (page 97).

- For precautions concerning the use of discs, usable discs, and formats, see “Cautions about Discs (X110 only)” (page 99) and “About the Supported Formats” (page 101).

Inserting/Ejecting a Disc

Inserting the Disc

Insert the disc with the label side facing up.

For X110

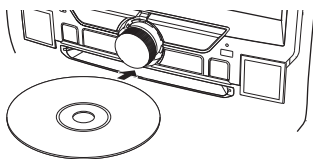

For X108U/INE-W967HD (DVE-5300)

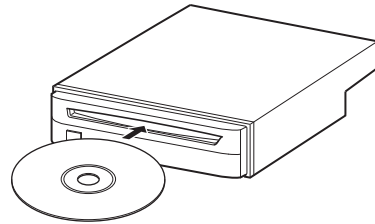

Insert the disc until it is automatically pulled into the unit.

- Do not touch the surface of the disc directly with your fingers.
- Before inserting or removing the disc, always turn the ignition key to ACC or ON.
- You cannot remove or insert the disc with the ignition key turned to OFF.

Removing the Disc

Press **▲ (Eject)** button.

When the disc has been ejected part way, take it out.

- Press the **▲ (Eject)** button on the front panel of the optional DVD Player (DVE-5300).
- If the disc cannot be ejected by pressing **▲ (Eject)**, press and hold **▲ (Eject)** again for at least 3 seconds.

DVD Player SETUP

You cannot perform DVD Player Setup while driving.

Your vehicle must be parked with the ignition key in the ACC or ON position. For details, see “To display the Setup Menu screen” in “Setup Operation” (page 29).

You can setup only when a disc is not inserted or playback pauses.

1 Touch **[⚙️] (Setup)**.

The Setup main screen is displayed.

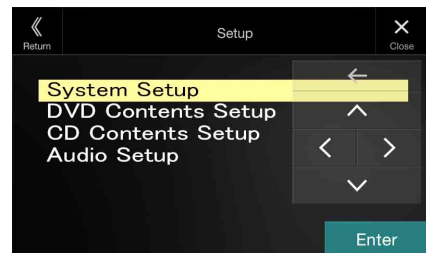

Setting items:

System Setup / DVD Contents Setup / CD Contents Setup / Audio Setup

2 Touch **[^]** or **[v]** to select the setting item.

3 Touch **[Enter]**, then touch **[<]**, **[>]**, **[^]** or **[v]** to change the setting item.

4 Touch **[X]** to return to the main source screen.

- Touch **[<<] (Return)** to return to the previous display.
- For details on the **[⚙️] (Setup)** button, see Function mode in “CD/MP3/WMA/AAC/WAV” (page 72) or “DVD” (page 73).

System Setup

Switching the Bar Color

Select the colors (8) used for highlighting items in the System Setup screen.

Setting items:

Bar Color

Setting contents:

Blue / Green / Light blue / Amber (Initial setting) / Aqua blue / Yellow / Red / White

Setting the TV Screen Mode

Setting item:

TV Screen → Aspect

Setting contents:

16:9 (Initial setting) / 4:3LB / 4:3PS

- For some discs, the picture may not be set to the selected screen size. (For details, refer to the explanation on the disc's jacket.)
- You can also switch the TV Screen Mode by touching [] (Display Mode) on the display of this unit. For details, see "Switching Display Modes (During Video File Play Back)" (page 60).

4:3 LETTER BOX:

Select this when connected to a conventional 4:3 size (normal TV aspect ratio) monitor. There may be black stripes visible at the top and bottom of the screen (when playing a 16:9 size movie). The width of these stripes will depend upon the original aspect ratio of the theatrical release of the movie.



4:3 PAN-SCAN:

Select this when connected to a conventional 4:3 size monitor. The picture will fill the entire TV screen. However, due to the mismatch in aspect ratio, parts of the movie at the extreme left and right sides will not be visible (when playing a 16:9 size movie).



16:9 WIDE:

Select this when connected to a wide screen TV. This is the factory setting.



Delaying Image Output

Use this function when an external audio processor is connected.

Depending on the connected audio processor, the audio and image currently played back may not be output at the same time. In this case, you can output an image delayed by 0.1 second by setting to On.

Setting item:

Video Delay

Setting contents:

Off (Initial setting) / On

On: Output image is delayed by 0.1 second.

- If a disc with a high compression rate is played back, the image and audio may be distorted.

Returning to the Initial Setting

You can return the contents you previously set to the initial factory settings.

Setting item:

Setup Initialize

Setting contents:

Yes / No (Initial setting)

Yes: Returns to the initial setting.

No: Does not return to the initial setting.

DVD Contents Setup

Setting the language

The audio language, subtitle language and menu language can be set according to your preferences.

Once set, this becomes the default language. This function is convenient when you always want to listen in English. (Not all discs allow changing the default language. If not, the factory default language applies.)

Setting item:

Languages

Setting contents:

Audio / Subtitle / Menu

Audio: Set the audio track language.

Subtitle: Set the language of the subtitles displayed on the screen.

Menu: Set the language used for the menus (title menu, etc.).

Further Setting contents:

Auto (Initial setting) / Off (Subtitle only) / English / French / Japanese / Italian / German / Swedish / Spanish / Chinese / Russian / Others

Auto: The disc is played with the audio language or subtitle language set as the priority language for the disc.

Off: Subtitles are not displayed. (Subtitle only)

Others: Set this to play the disc with a language other than one of the languages displayed. Touch [Enter], then use the numeric keypad ("0" to "9") to input the 4-digit language code. Then touch [Enter] again. For the language codes, refer to "List of Language Codes" (page 104).

- If you change the language setting when the disc is in the unit, the setting is decided with one of the following operations.
 - Disc eject.
 - Turn OFF the main unit.
 - Switch the source on the head unit.
- To temporarily change the language of the current disc, either do so from the DVD menu or using the operation described in the section "Switching the Audio Tracks" (page 77).
- If the disc does not include the selected language, the disc's default language is set.

- Languages set upon shipment from the factory:
Audio language : Auto
Subtitle language : Auto
Menu language : Auto
- Touch [K] (Return) to return to the previous display.

CD Contents Setup

Playing MP3/WMA/AAC/WAV Data

Setting item:

CD Play Mode

Setting contents:

CD-DA / Compress (Initial setting)

This unit can play back CDs containing both CD and MP3/WMA/AAC/WAV data (created in Enhanced CD (CD Extra) format).

- CD-DA: Only CD data can be played back.
- Compress: Only MP3/WMA/AAC/WAV data can be playedback.

Setting the Video CD Play Mode

When playing a Playback Control (PBC) enabled video CD, you can choose to set PBC On or Off.

Setting item:

VCD Play Mode

Setting contents:

PBC On (Initial setting) / PBC Off

- PBC On: The PBC menu is displayed.
- PBC Off: The PBC menu is not displayed.

- You can set PBC On or Off directly by pressing MENU.

Displaying the Disc Status Automatically (CD/MP3/WMA/AAC/WAV only)

When playing a CD/MP3/WMA/AAC/WAV file, you can choose to display the Disc Status (track number, etc.) automatically.

Setting item:

Audio Display

Setting contents:

Off / On (Initial setting)

- On: The Disc Status is displayed automatically while playing back.
- Off: Disc Status is not displayed automatically while playing back.

Audio Setup

Setting the Digital Output

Use the following procedure to set the digital audio signal output from the DVE-5300 (DVD Player).

Setting item:

Digital Out

Output Modes:

Dolby D / DTS

Setting contents:

Bitstream / LPCM (Initial setting)

- Bitstream: Select "Bitstream" when you want to connect a digital audio processor to play Dolby Digital or DTS audio. When "Bitstream" is selected, the HDMI audio will be muted. The DVE-5300 (DVD Player) optical output must be used for the external processor.
- LPCM: The audio signal recorded on the disc is converted to 48 kHz/16 bit (for DVDs) or 44.1 kHz (for video CDs and CDs) linear PCM audio signals for output.

- Touch [K] (Return) will return to the previous screen.
- Set to "LPCM" to connect to the unit.

Digital audio output

Disc	Audio recording format		Digital output setting	Optical digital audio output (when a digital audio processor is connected)	Digital audio output (HDMI output)
	Fs	Q			
LPCM (DVD, CD)	48/96kHz	16/20/24bit	Bitstream	LPCM 2ch Down mix (48kHz/16bit)	—
			LPCM		LPCM 2ch Down mix (48kHz/16bit)
	44.1kHz	16bit	Bitstream	LPCM 2ch (44.1kHz/16bit)	—
			LPCM		LPCM 2ch (44.1kHz/16bit)
Dolby Digital (DVD)	48kHz	16/18/20bit	Bitstream	Bit stream (Max 7.1ch)	—
			LPCM	LPCM Encode 2ch Down mix (48kHz/16bit)	LPCM Encode 2ch Down mix (48kHz/16bit)
DTS (DVD, CD)	48/96kHz	16/20/24bit	Bitstream	Bit stream (Max 6.1ch)	—
			LPCM	LPCM Encode 2ch Down mix (48kHz/16bit)	LPCM Encode 2ch Down mix (48kHz/16bit)
	44.1kHz	16/20/24bit	Bitstream	Bit stream (Max 5.1ch)	—
			LPCM	LPCM Encode 2ch Down mix (44.1kHz/16bit)	LPCM Encode 2ch Down mix (44.1kHz/16bit)
MPEG1 (DVD, Video CD)	48kHz	16bit	Bitstream	Bitstream (Max 5.1ch)	—
			LPCM	LPCM Encode 2ch Down mix (48kHz/16bit)	LPCM Encode 2ch Down mix (48kHz/16bit)
	44.1kHz	16bit	Bitstream	Bit stream	—
			LPCM	LPCM Encode 2ch (44.1kHz/16bit)	LPCM Encode 2ch (44.1kHz/16bit)
MPEG2 (DVD)	48kHz	16bit	Bitstream	Bit stream (Max 5.1ch)	—
			LPCM	LPCM Encode 2ch Down mix (48kHz/16bit)	LPCM Encode 2ch Down mix (48kHz/16bit)
MP3/WMA/AAC	8/11.025/12/16/22.05/24/32/44.1/48kHz	16bit	Bitstream	LPCM Encode 2ch (32kHz, 44.1kHz or 48kHz/16bit)	—
			LPCM		LPCM Encode 2ch (32kHz, 44.1kHz or 48kHz/16bit)
WAV	44.1kHz	16bit	Bitstream	LPCM Encode 2ch (44.1kHz/16bit)	—
			LPCM		LPCM Encode 2ch (44.1kHz/16bit)

Setting the Downmix Mode

This function applies to Dolby Digital, DTS stream sound.

Setting item:

Downmix Mode

Setting contents:

Stereo (Initial setting) / Surround Encoded

- Stereo: Stereo Downmix.
- Surround: Surround compatible Downmix.
- Encoded:

CD/MP3/WMA/AAC/WAV

MP3/WMA/AAC main screen example

Info mode

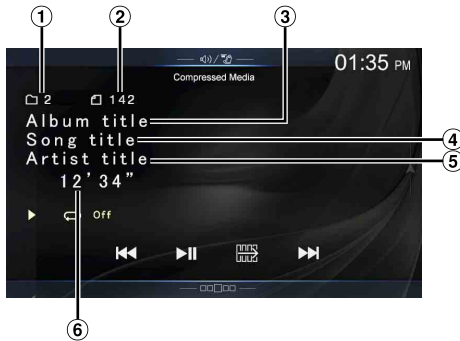

Function mode (MP3/WMA/AAC)

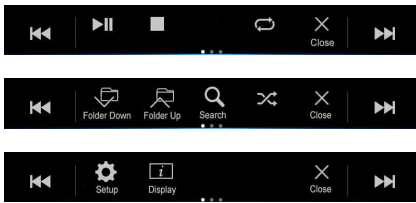

- ① Current song no.
- ② Total song no.
- ③ Album title
- ④ Song title
- ⑤ Artist title
- ⑥ Elapsed time

Function mode (CD)

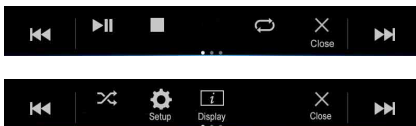

- If there is no CD text, the message “No Text” appears.

Playback

1 Press the **⏮** (AUDIO) button to select DVD (CD) mode.

The display shows the DVD (CD) mode screen.

- You can also select and change from the Menu screen (page 21) or Favorite screen (page 24).

When a disc is inserted into the disc slot of the DVD Player, with the label side facing up, the unit starts playback of the disc.

2 Touch [**⏮**] or [**⏭**] to select the desired track (file).

Returning to the beginning of the current (or previous) track (file):

Touch [**⏮**].

Fast reverse :

Touch and hold [**⏮**].

Advancing to the beginning of the next track (file) :

Touch [**⏭**].

Fast forward :

Touch and hold [**⏭**].

- The [**⏮**], [**⏭**] buttons provide the same functions above.

3 To pause playback, touch [**⏸** / **⏹**].

- The unit can play back MP3/WMA/AAC/WAV files saved to CD or DVD.
For further information about playing or storing MP3/WMA/AAC/WAV files, see pages 101 and 102 before using the unit.
- Any file protected by DRM (Digital Rights Management) copy protection, cannot be played back on this unit.
- If a disc contains both audio data and MP3/WMA/AAC/WAV data, this unit plays back only the audio data.
- The track display for CD audio data playback shows the track numbers recorded on the disc.
- If an MP3/WMA/AAC/WAV disc with many files and folders is played, it may take longer than normal to start playback.
- The playback time may not be correctly displayed when a VBR (Variable Bit Rate) recorded file is played back.
- For details on switching the HDMI source when you have connected the HDMI selector and two HDMI devices, see “Switching the source when two HDMI devices are connected” (page 78).

Stopping Playback

Touch [⏹**] during playback.**

“STOP” indicator is displayed, and playback stops.

- Playback starts from the beginning when [**⏸** / **⏹**] is touched while playback is stopped.

Repeat Play

Touch [⏮**] to repeatedly play back.**

The tracks (files) will be played repeatedly.

The repeat mode switches every time the button is touched.

CD:

Track Repeat → Off → Track Repeat

MP3/WMA/AAC:

Repeat File → Repeat Folder* → Off → Repeat File

- * Only files in a folder are repeatedly played back.

- If the Repeat Play mode is activated during MIX playback, the MIX mode will be canceled.

MIX (Random Play)

Touch [↻] during playback.

The tracks (files) on the disc will be played back in a random sequence.

The MIX mode switches every time [↻] is touched.

CD:

MIX → Off → MIX

MP3/WMA/AAC:

MIX Folder*1 → MIX Disc*2 → Off → MIX Folder*1

*1 Only files in a folder are played back in random sequence.

*2 All files on the disc will be played back in a random sequence.

- If the MIX mode is activated during Repeat playback, the Repeat Play mode will be canceled.
- If you select a track by using the search mode, the MIX play mode will be canceled.

File/Folder Name Search (Concerning MP3/WMA/AAC/WAV)

1 Touch [🔍] (Search) during playback.

The search mode is activated.

The mode is changed to the search mode, and the list select panel appears.

2 Touch [^] or [v] in the list select panel to select Folder or File, then touch [Enter].

When selecting Folder, select File following same procedure, then touch [Enter].

- When there are 9 or more names on the list, a page number is displayed. Touch [<] or [>] to change the page.
- Touch [←] or [→] to change the list select panel location from right to left or vice-versa.
- To return to the previous hierarchy, touch [<].

Selecting Folders (Concerning MP3/WMA/AAC/WAV)

Touch [📁] (Folder Down) or [📁] (Folder Up) to select the folder.

Info Mode Function

You can display the DISC information.

1 During playback, touch [i] (Display).

The playback status is displayed.

2 The playback status display closes when [i] (Display) is touched.

- For details on the display example, see Info mode in "MP3/WMA/AAC main screen example" (page 72).

DVD

DVD Video main screen example



Function mode

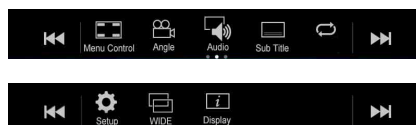

Info mode



- ① Title no./Chapter no.
- ② Audio signal output/Subtitle/Angle
- ③ Elapsed time

Video CD main screen example

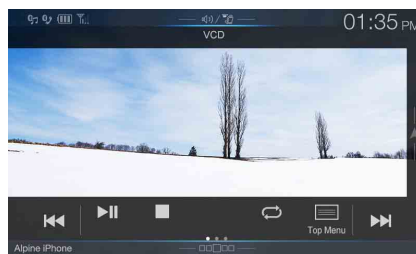

Function mode

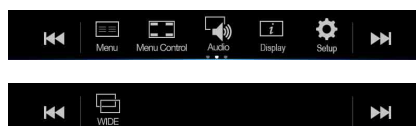

Info mode



- ① Current track no.
- ② Playback control (PBC)/Current audio status
- ③ Elapsed time

Disc types that can be used for each heading are represented by the following marks.

DVD-V DVD Commercial Video discs (used for the distribution of movies, etc.) or a DVD-R/DVD-RW, DVD+R/DVD+RW recorded in a video mode can be used.

VCD Video-CD discs can be used.

The DVD operation screen display

Touch the screen while the DVD playback screen is displayed. To display the operation screen, touch [Control].

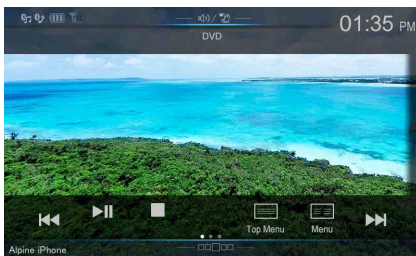

- The operation screen changes to the visual screen in the DVD mode for 5 seconds after an operation has been performed.
- If you try to activate the DVD while driving, the display will show the warning-Picture off for your safety.
- Some operations cannot be carried out depending on the disc or playback screen.

Playing a Disc **DVD-V** **VCD**

⚠ WARNING

It is dangerous for the driver to watch the DVD while driving the vehicle. The driver may be distracted from looking ahead and an accident could occur.

Install the unit correctly so that the driver cannot watch DVD unless the vehicle is stopped and the emergency brake is applied.

If the unit is not installed correctly, the driver will be able to watch DVDs while driving the vehicle and may be distracted and could cause an accident. The driver or other people could be severely injured.

⚠ CAUTION

- Not all functions will operate for every DVD. See the individual DVD's instructions for details on the features supported.
- Fingerprints on a disc may adversely affect playback. If a problem occurs, remove the disc and check for fingerprints on the playback side. Clean the disc if necessary.
- If you switch the power or Ignition key OFF or change sources during playback, playback will continue where you left off when you resume playback.
- If you try to perform an invalid operation (based on the type of disc being played), the following mark is displayed on the monitor screen: Ⓞ

- **Play Position Memory Function**
Even if you turn power off or switch the Ignition key to OFF during playback or change the source, playback will continue from the point where playback stopped when the power is turned ON again.

1 Press the **🎵 (AUDIO)** button to select DVD (CD) mode.

The display shows the DVD (CD) mode screen. When a disc is inserted into the disc slot of the DVD Player, with the label side facing up, the unit starts playback of the disc.

- The reverse side of a double-sided DVD will not be played automatically. Remove the disc, turn it over, and reinsert it.
- DO NOT insert discs containing maps for the navigation system. Doing so could result in damage.
- For details on switching the HDMI source when you have connected the HDMI selector and two HDMI devices, see "Switching the source when two HDMI devices are connected" (page 78).
- For your safety, video is not displayed and only audio can be heard while driving.

If a Menu Screen Appears

On DVD mode, menu screens may appear automatically. If this happens, perform the operation described below to start playback.

Direct Menu Operations (DVD-V)

- 1 Touch the screen while the DVD menu is being displayed.**
Directly touch operation switches displayed on the screen to operate.
 - To display the operation screen, touch [Control].

- 2 Touch the DVD menu directly.**
 - Some operations cannot be performed depending on the disc.

Menu Operations (DVD-V) (V CD)

- 1 Touch [Key] (Menu Control).**
The menu operation mode will be displayed.

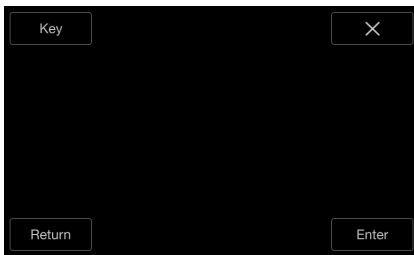

- You cannot operate them while driving.

- 2 Touch [Key].**
The Key panel is displayed.
Touch [Return] to return to the previous display.

- 3 Select a desired menu item by touching [↖], [↗], [↙] or [↘].**

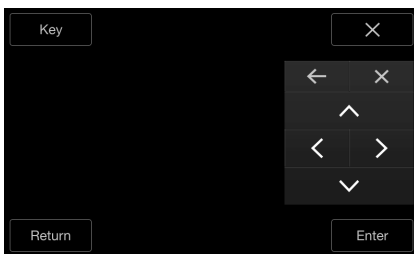

- Touch [↖] or [↗] to change the Key panel location from right to left or vice-versa.
- Touching [X] in the operation panel returns to the screen in step 1.
- Touching [Key] displays the numeric keypad input mode screen. For details of the numeric keypad input mode screen, see "Numeric Keypad Input Operations" (page 75).

- 4 Touch [Enter] to confirm the selected item.**

Numeric Keypad Input Operations (DVD-V)

- 1 Touch [key] again in the menu operation mode.**
The numeric keypad input mode screen appears
- 2 Touch a desired number.**

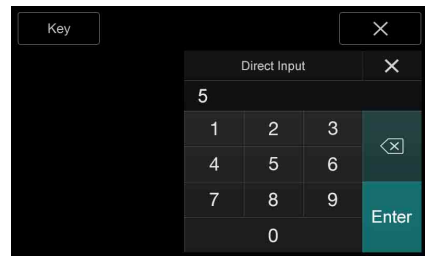

Touch [X] to delete an entered number.
To delete all the numbers you have entered, touch [X] for at least 2 seconds.

- 3 Touch [Enter] on the numeric keypad input mode screen to confirm your selection.**
Touch [X] to hide the keypad display.
 - You cannot operate them while driving.

Displaying the Top Menu Screen

(DVD-V) (V CD)

When a DVD contains two or more titles, the top menu screen appears.

Touch [≡] (Top Menu).
The top menu screen appears.

- To perform necessary operations, see "If a Menu Screen Appears" (page 75).

Displaying the Menu Screen (DVD-V) (V CD)

With a DVD having two or more menus, a menu screen will appear for the programmes available, in addition to the main programmes.

Touch [≡] (Menu).
The Root menu screen appears.

- To perform necessary operations, see "If a Menu Screen Appears" (page 75).

Playing Still Frames (Pausing) (DVD-V) (V CD)

- 1 During playback, touch [▶/||].**
- 2 Touch [▶/||] to resume playback.**
 - No sound is played during the still frame mode.
 - The image or sound may stop temporarily when playback starts from the pause mode. This is not a malfunction.

Stopping Playback (DVD-V) (V CD)

Touch [■] during playback.

"■" indicator is displayed, and playback stops.

- Playback starts from the beginning when [▶/||] is touched while playback is stopped.

Fast-forwarding/Fast-reversing (DVD-V) (V CD)

1 During playback, touch and hold [◀◀] (Fast-reverse) or touch and hold [▶▶] (Fast-forward).

Touch and hold for more than 1 second to forward/reverse at double speed.

Every time you touch [◀◀]/[▶▶] during fast-reverse/fast-forward, the speed changes as follows: 2x → 8x → 32x → 2x.

2 Touch [▶/||] to return to normal playback.

- No sound is played back during fast-forwarding/fast-reversing.
- On DVD mode, the menu screen may reappear during fast-forwarding/fast-reversing.
- This operation may not be possible on certain discs.

Finding the Beginnings of Chapters/Tracks/Files

(DVD-V) (V CD)

During playback, touch [◀◀] or [▶▶].

The chapter/track/file switches each time the button is touched, and playback of the selected chapter/track/file starts.

- ▶▶: Touch this to start playback from the beginning of the following chapter, track or file.
- ◀◀: Touch this to start playback from the beginning of the current chapter, track or file.

- Some DVDs do not have chapters.
- Be sure to turn PBC off before starting the search. See "Setting the Video CD Play Mode" (page 71).

Supplementary explanations

"Chapters" are divisions of movies or musical selections on DVDs.

"Tracks" are divisions of movies or musical selections on Video CD.

Forward/Reverse frame-by-frame Playback

(DVD-V) (V CD)

1 In the pause mode, touch [◀◀] or [▶▶].

The picture advances by one frame each time the button is touched.

2 Touch [▶/||] to return to normal mode.

- No sound is output during forward frame-by-frame playback.
- You can only execute reverse frame-by-frame playback when playing DVD-V.

Repeat Playback (DVD-V) (V CD)

Use this function to play the disc's titles, chapters or tracks, etc., repeatedly.

Touch [↺] to repeatedly play back.

The repeat mode switches every time the button is touched.

DVD Video

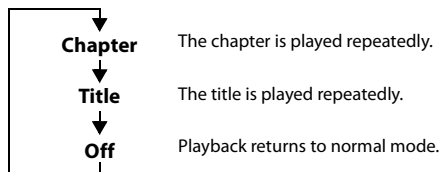

- The Repeat mode is always turned off when [↺] is touched and held for at least 2 seconds.
- Only discs containing a Playlist can be displayed.

Video CD

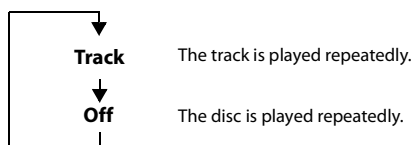

- Display may vary depending on the connected devices.
- The track/disc repeat modes cannot be used on Video CDs with playback control (PBC). These modes can be carried out after turning PBC off. See "Setting the Video CD Play Mode" (page 71).
- For some discs it is not possible to switch the repeat mode.

Searching by Title Number

Use this function to easily find positions on the DVD using the DVD's titles. Perform operations while playback is stopped.

- 1 Touch  (Menu Control).**
The menu operation mode screen appears.
- 2 Touch [Key] again in the menu operation mode.**
- 3 Enter a desired title by touching its number.**
See page 75 for operation of the numeric keypad.
- 4 Touch [Enter].**
Playback will start from the number selected.
- 5 Touch [X].**

- This function cannot be used on discs on which no title numbers are recorded.
- Some disc may not accept any operation.
- You cannot operate them while driving.

Searching Directly by Chapter Number

Use this function to easily move to the beginnings of the chapters on the disc. Perform operations during playback, during PRE-STOP or while playback is paused.

- 1 Touch  (Menu Control).**
The menu operation mode screen appears.
- 2 Touch [Key] again in the menu operation mode.**
- 3 Touch and enter the chapter number you want to play.**
See page 75 for operation of the numeric keypad.
- 4 Touch [Enter] to confirm your selection.**
Playback will start from the selected chapter.
- 5 Touch [X].**

- This function is not available for a disc on which chapters are not stored.
- You cannot operate them while driving.

Switching the Angle

On DVDs in which scenes have been filmed from multiple angles, the angle can be switched during playback.

Touch (Angle).

The angle switches between the angles recorded on the disc every time the button is touched.

- Some time may be required for the angle to change.
- Depending on the disc, the angle may switch in one of two ways.
 - Seamless: The angle switches smoothly.
 - Non-seamless: When the angle is switched, a still picture is displayed first, after which the angle switches.

Switching the Audio Tracks

DVDs with multiple audio tracks or languages allow switching the sound during playback.

Touch (Audio).

The sound switches between the alternate audio tracks recorded on the disc every time the button is touched.

- The alternate track selected becomes the default setting every time the power is turned on or the disc is replaced. If the disc does not include that track, the disc's default language is selected instead.
- Not all discs will allow changing the alternate audio tracks during playback. In these cases, select audio tracks from the DVDs menu.
- There may be a delay before the selected alternate track begins to play.

Video CDs with multiplex audio

Touch (Audio).

The left and right channels will be output as shown below, each time the button is touched.

Audio: LL → Audio: RR → Audio: LR → Audio: LR

Switching the Subtitles (Subtitle Language)



With DVDs on which multiple subtitle languages are recorded, the subtitle language can be switched during playback; moreover, subtitles can be hidden.

Touch (Sub Title).

Touching this button repeatedly selects sequentially the subtitle languages recorded on the disc, and then turns the subtitles OFF.

- There may be a delay before the selected subtitle appears.
- Not all discs will allow changing the subtitles during playback. In these cases, select subtitles from the DVDs menu.
- The subtitle language selected becomes the default setting every time the power is turned on or the disc is replaced. If the disc does not include that language, the disc's default language is selected instead. However, the subtitle language may differ depending on the disc.
- For some discs, the subtitles will be displayed even when this is set to OFF. However, the subtitle language may differ depending on the disc.

Info Mode Function

You can display the DISC information.

1 During playback, touch (Display).

The playback status is displayed.

2 The playback status display closes when (Display) is touched.

- For details on the display example, see Info mode in "DVD Video main screen example" (page 73) or "Video CD main screen example" (page 73).

Switching Display Modes

You can switch the Display Mode by touching  (Display Mode).

For details, see "Switching Display Modes (During Video File Playback)" (page 60).

- You cannot operate them while driving.

HDMI Operation

WARNING

It is dangerous for the driver to watch the HDMI image while driving the vehicle. The driver may be distracted from looking ahead and an accident may occur.

Install the unit correctly so that the driver cannot watch the HDMI image unless the vehicle is stopped and the emergency brake is applied.

If the unit is not installed correctly, the driver will be able to watch the HDMI image while driving the vehicle and may be distracted causing an accident. The driver or other people may be severely injured.

■ iPhone, Smartphone, etc.

The output of your electronic device will be mirrored on this unit through the HDMI connector. Control from this unit is not possible.

- The electronic device must possess an HDMI output interface.
- Not all devices with an HDMI output interface can be recognized by this unit.
- Use only the Alpine Special HDMI connection cable.

1 Press the (AUDIO) button to select HDMI mode.

The display shows the HDMI mode screen.

- You can select and change the source in the Menu screen (page 21) or Favorite screen (page 24).
- For your safety, video is not displayed and only audio can be heard while driving.

2 In HDMI player mode, the screen of the device displays the content of electronic equipment by mirror image.

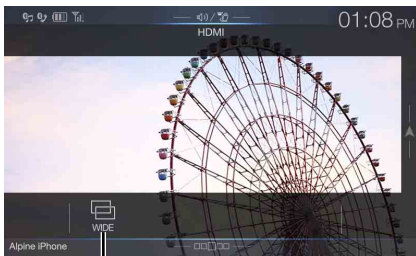

- ① You can select Display Mode.
For details, see "Switching Display Modes (During Video File Play Back)" (page 60).

- You cannot operate them while driving.

Switching the source when two HDMI devices are connected

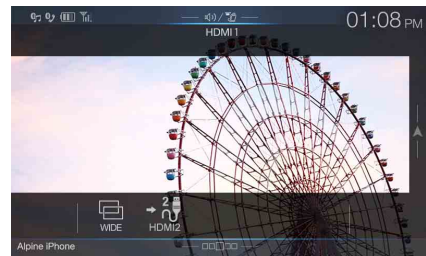

You can switch the source only when you have connected the HDMI selector and "Setting the HDMI Selector On/Off" (page 50) is set to "On."

■ Screen example when the HDMI Setup is "HDMI 1"



Touch [] (HDMI 2).

The HDMI source changes to HDMI 2, and the Function button changes to [] (HDMI 1).

Each time you touch [] (HDMI 1)* or [] (HDMI 2), the HDMI source changes.

* When HDMI Setup is "DVD," the Function button is changed to [] (DVD).

Bluetooth Operation

Setup Before Using

About Bluetooth

Bluetooth is a wireless technology allowing communication between a mobile device or personal computer over short distances. This enables a hands-free call or data transmission between Bluetooth compatible devices. Bluetooth transmission is available in the unlicensed 2.4 GHz spectrum if the distance between devices is within 10 meters. For details, refer to the Bluetooth website (<http://www.bluetooth.com/>).

- Depending on the Bluetooth version, a Bluetooth compatible device may not be able to communicate with this unit.
- Proper function of this unit with all Bluetooth compatible devices is not guaranteed. For handling of the Bluetooth compatible device, consult your Alpine dealer or Alpine website.
- Depending on the surroundings, Bluetooth wireless connection may be unstable.
- When you place a call, or perform setup operations, be sure to stop your car in a safe place.
- Depending on the connected Bluetooth compatible device(s), the function may differ. Also refer to the Owner's Manual of the connected device(s).

About the Hands-free Phone

Hands-free calls are possible when using a HFP (Hands-Free Profile) compatible mobile phone with this unit.

- Avoid performing a hands-free call in heavy traffic or on narrow or winding streets.
- Close the windows while calling to reduce background noise.
- If both calling parties are using hands-free devices, or the call is made in a noisy location, difficulty hearing the other person's voice is normal.
- Depending on telephone line conditions or certain mobile devices used, voices may sound unnatural.
- When using a microphone, speak as directly as you can into the microphone to obtain the best sound quality.
- Certain mobile phone features are dependent on the capabilities and settings of your service provider's network. Additionally, certain features may not be activated by your service provider, and/or the provider's network settings may limit the feature's functionality. Always contact your service provider about feature availability and functionality.

All features, functionality, and other product specifications, as well as the information contained in the Owner's Manual are based upon the latest available information and are believed to be accurate at the time of printing.

Alpine reserves the right to change or modify any information or specifications without notice or obligation.

Before Using Bluetooth

Before using the hands-free phone/audio function, the following settings need to be made.

1 Set "Bluetooth" to "On" (☑).

2 Register a Bluetooth device in this unit (page 30).

- See "Bluetooth Setup" (page 30).
- You can search for this unit using a Bluetooth compatible device, and then connect that Bluetooth compatible device to this unit. The device name of this unit is "ALPINE NAVI" and the initial number of the passcode is "0000." Also refer to the Owner's Manual of the connected device(s).
- Before using the hands-free function, make sure "Setting the Hands-free Connection" (page 48) is set to "Aftermarket" or "Factory."

Hands-free Phone Control

Touch [Phone] in the Menu screen to display the Phone menu screen (page 79).



[Phone] button

Phone menu screen example

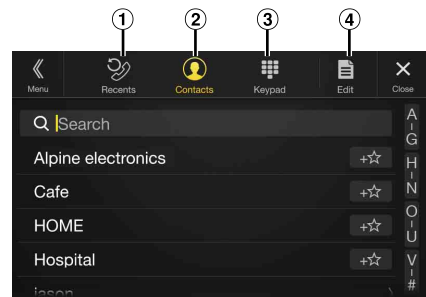

- ① Recent Events list*
You can display up to 60 items, such as phone numbers of the most recent incoming calls, missed calls and outgoing calls, and contact names that are registered in the Phone Book. When 60 items exist in the list, the oldest item is deleted when a further item is to be added.
- ② Contacts list*
You can make a phone call from the Phone Book, or edit the Phone book.
- ③ Keypad screen
Use to type a phone number.
- ④ Edit*
Use to edit the Contacts list.

* When you connect two Hands-Free Phones, the information of the Bluetooth device set to Primary is displayed.

Answering a Call

Incoming calls are announced by the received call ring tone and a displayed message (PHONE No., etc.).

- 1 **An incoming call triggers the ringtone and an incoming call display.**

Incoming call notification screen

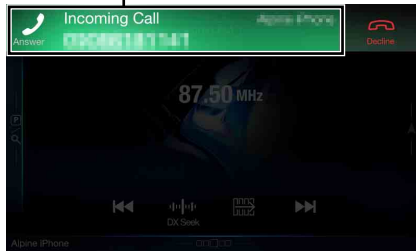

- 2 **Touch incoming call notification screen.**
The call starts.

Call info area

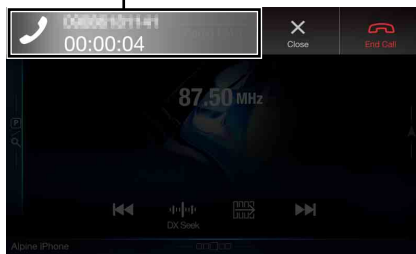

- During a call, the audio for the current mode on the unit is muted. After calling, playback will resume.
- When the caller's number is transmitted to the system, if the caller's name is stored in the phone book, the name is displayed. If the name is not stored, the number is displayed.
- Touch [📞] (**Decline**) to reject an incoming call.
- By touching the call info area during phone call, you can change to the Phone Operation screen and adjust the speech volume, etc. For details, see "Operations During a Conversation" (page 83).
- Touch [X] during a conversation to hide the call info area. To display it again, Touch or swipe downward on [📞] on the upper part of the screen.
- During an incoming call or a conversation on the Primary (Secondary) Hands-Free Phone, if there is an incoming call on the Secondary (Primary) Hands-Free Phone, you cannot answer the call on the Secondary (Primary) Hands-Free Phone without first ending the call on the Primary (Secondary) Hands-Free Phone.

Hanging up the Telephone

- 1 **Touch [📞] (End Call).**
The call finishes.

Call Waiting Function

If a call comes in from another phone during a call, a notice is displayed on the screen. This function can only be used if the connected mobile phone has a call waiting function service included.

Second incoming call during a conversation in the call info area

Second incoming call notification screen

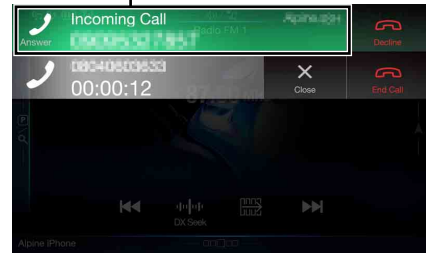

By touching the second incoming call notification screen, you can put the current call on hold and answer the second call.

On-hold screen

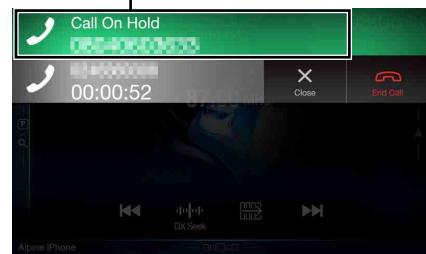

- To switch a party, touch the on-hold screen.
- To finish a call, touch [📞] (**End Call**).

Second incoming call during a conversation in the Phone Operation screen

- The display or operation may differ depending on the connected mobile phone or the caller's mobile phone.

Second incoming call notification screen

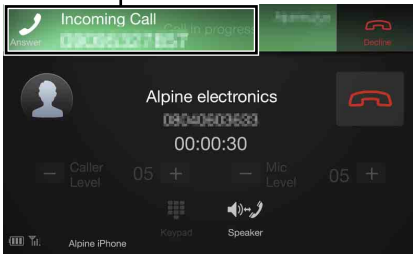

By touching the second incoming call notification screen, you can put the current call on hold and answer the second call.

Call On Hold screen

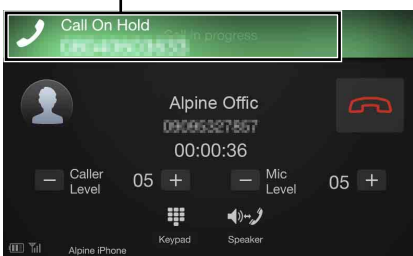

- To switch a party, touch the on-hold screen.
- To finish a call, touch [End Call].
- This unit supports only the Call Waiting function of a mobile phone. The second call function and three-way calling function of a mobile phone cannot be operated from this unit. Also the screen display may malfunction.

Calling

Calling by Favorite Function

You can make a phone call using the Short Cut function of numbers that have been registered in Favorite. For details, see "Favorite Function" (page 24).

- Press the ★ (Favorite) button.
The Favorite screen is displayed.

Favorite screen



- Touch the Short Cut icon.

A contact's name, phone number, and a confirmation message of the phone number are displayed.

- Touch [Call].

The phone call is started.

Making a phone call using the Phone Menu

Making a phone call from the Recent Events list

- Touch [Recent] (Recents) to change to the Recent Events list screen.

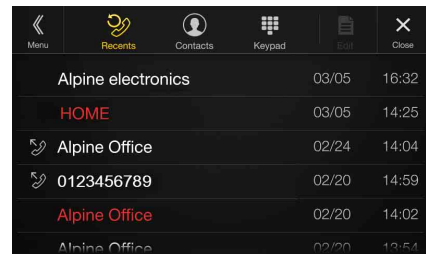

Dialled history:

Names or Numbers/Date

Received history:

Names or Numbers/Date

Missed Incoming history:

Names or Numbers/Date

- Touch the name of the contact you want to call.

The Detail info screen is displayed.

- Touch [Call].

The phone call is started.

Calling from the Contacts list (Phone Book)

- Touch [Contacts] (Contacts) to change to the Contacts list screen.

- Touch the name of the contact you want to call.

The Phone Operation screen is displayed.

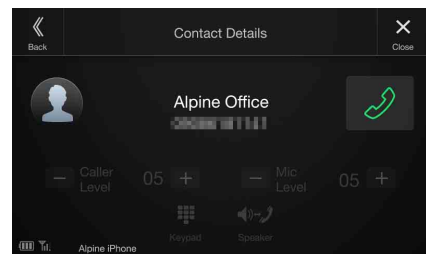

- Touch [Call].

The phone call is started.

Entering a Phone Number to Make a Call

1 Touch [☰] (Keypad).

The number input screen (Keypad) appears.

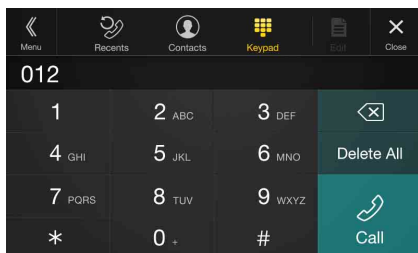

Touch [X] to delete an entered number.

Touch [Delete All] to delete all entered numbers.

2 Enter the phone number you wish to call.

- You can enter up to 31 digits.

3 Touch [📞] (Call).

A confirmation message of the phone number appears.

4 Touch [Call].

The phone call is started.

Using Voice Recognition function

You can use Siri function of your iPhone or make a telephone call by using voice operation of your smartphone.

Using Siri

You can use the Siri function of your iPhone. To use this function, set the Siri setting of your iPhone to ON.

- Connect your iPhone to the unit via Bluetooth, then set to “Hands-free” or “Both” (page 30).
- The available functions differ depending on the connected iPhone.
- Ask Siri to play a track from the music library applies only to USB source.
- Siri and other streaming services are enabled by connecting to compatible smartphones that are able to receive data. Please ensure that cellular data and/or Wi-Fi is turned on in the smartphone to enjoy these features.
- Extensive use of Siri or other streaming services may increase your phone’s data usage. Please check with your phone company to ensure you have an appropriate Data plan.

1 Press and hold the 🎵 (AUDIO) button for at least 2 seconds.

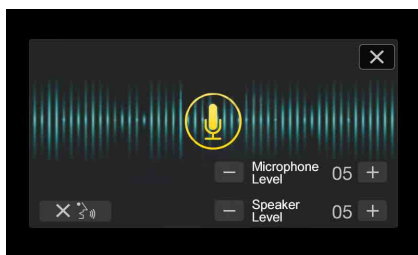

The Voice Control mode screen is displayed.

2 Speak into the microphone supplied with this unit.

- If no speech is detected, the unit may pause depending on version of the connected iPhone. In that case, touch the microphone icon [🎤] in the center of the Voice Control mode screen. You can continue to use the Voice Control mode.

3 To finish the Voice Control mode, touch [X] or press and hold the 🎵 (AUDIO) button for at least 2 seconds.

- Depending on the iPhone, the Siri function may finish automatically.

Adjusting the volume

Adjust the speaker/microphone volumes in Voice Control mode.

Perform the same procedure to adjust the speaker/microphone volumes of hands-free phone.

Touch [–] or [+].

Adjust the speaker and microphone volumes.

Stopping input to the microphone

If the surrounding sound (road noise, etc.) is loud, you may wish to cut input to the microphone for 3 seconds.

Touch [X 🎵].

Voice Dial Function

You can make a telephone call by using voice operation.

- Connect your smartphone to the unit via Bluetooth, then set to “Hands-free” or “Both” (page 30).

1 Press and hold the 🎵 (AUDIO) button for at least 2 seconds.

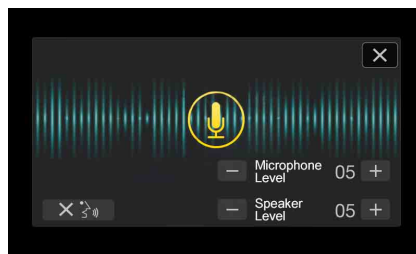

The Voice Dial mode screen is activated.

2 Say the telephone number* or name* you want to call, into the microphone.

- * The number and name depend on the voice dial information stored in the smartphone.

3 To finish the Voice Dial mode, touch [X] or press and hold the 🎵 (AUDIO) button for at least 2 seconds.

- You can perform this operation only when a voice dial compatible smartphone is connected.
- The Voice Dial function performance depends on the recognition range of the smartphone and mounting location of the microphone. Note when the microphone is mounted.
- Voice dial operation depends on the function being available on the smartphone. For details, refer to the owner’s manual of the smartphone.
- Depending on the smartphone, the Voice Dial operation may finish automatically.

Adjusting the volume

Adjust the speaker/microphone volume in Voice Dial mode. Perform the same procedure to adjust the speaker/microphone volume of hands-free phone.

Touch [–] or [+].

Adjust the speaker and microphone volumes.

Stopping input to the microphone

If the surrounding sound (road noise, etc.) is loud, you may wish to cut input to the microphone for 3 seconds.

Touch [X] [🔊].

Operations During a Conversation

Phone Operation screen

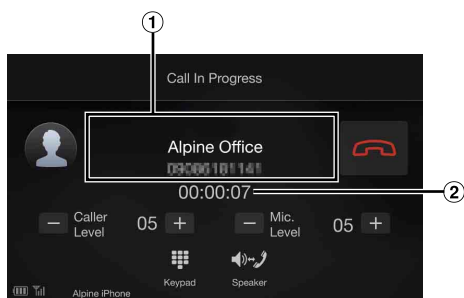

- 1 Name and phone number
 - If registered with a Group, the Group Name is also displayed. Although, depending on the connected mobile phone, it may not be displayed.
- 2 Conversation time

Adjusting the Speech Volume

You can adjust Caller Level and Mic. Level (Microphone Level) during a phone call.

Touch [–] or [+].

You can adjust the volume in 11 levels.

Changing the Voice Output

The voice output for calls is switchable between car speakers and the mobile phone speaker.

Touch [🔊] (Speaker).

- Depending on the mobile phone, this operation may not be possible.

DTMF (Touch-Tone) Function

Transmits a DTMF (Touch-Tone) during a call.

1 Touch [🔑] (Keypad).

The number input screen (Keypad) appears.

2 Input number.

- You can transmit a Touch-Tone signal during a call.

Phone Book Function

Phone Book screen example

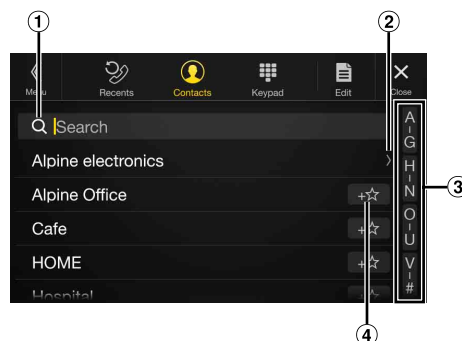

- 1 Use to search by directly inputting a name or phone number with the Keypad.
For details, see “How to Input Characters and Numbers (Keypad)” (page 23).
- 2 Displayed when multiple phone numbers are registered.
Touch [>] to display the registered phone number list.
- 3 Use to narrow down your search for names, etc.
For details, see “Alphabet Search Function” (page 59).
- 4 Touch [+★] to register as Favorite.

Synchronizing the Phone Book

You can synchronize the system's phone book with the mobile phone's phone book.

1 Touch [📄] (Edit).

2 Touch [Download].

3 Touch [SYNC].

Synchronization of the phone books starts.

- You can store up to 1,000 registered name in the phone book.
- You can store up to 5 phone numbers by one person's name.

Adding the Phone Book

1 Touch [📄] (Edit).

2 Touch [Download].

3 Touch [Add].

Stays on standby for connection of the mobile phone.

- Touch [Cancel] to cancel the standby mode.

4 The mobile phone accesses this unit and then transfers the phone book from the mobile phone to this unit.

- Mobile phone connection is canceled while the phone book is being transferred.

Deleting the Phone Book Entries

Deleting One Entry from the Phone Book

- 1 Touch [Edit].
- 2 Touch the checkbox [] of the contact name (or phone number) you want to delete. A tick [] appears in the checkbox.
 - You can choose up to 10 names and numbers at a time.
- 3 Touch [Delete].
The confirmation screen is displayed.
If multiple phone numbers are registered, they are all deleted.
- 4 Touch [OK].
The selected number is deleted.

Deleting All Entries from the Phone Book

- 1 Touch [Edit].
- 2 Touch [Delete All].
The confirmation screen is displayed.
- 3 Touch [OK].
All entries of the phone book are deleted.

Searching in the Phone Book

You can make a call using the phone book search function.

- 1 Touch [Search].
The Input User Name screen (Keypad) is displayed.
 - 2 Input the string of letters of the name that you want to search, then touch [OK].
A list of names beginning with the string of letters you entered is displayed.
 - 3 Touch the name you want to call.
The Phone Operation screen is displayed.
 - 4 Touch [Call].
The phone call is started.
- For details of how to input characters using the keypad, see "How to Input Characters and Numbers (Keypad)" (page 23).
 - If there are fewer than five registered items in the phone book, you cannot use the phone book search function.

Bluetooth Audio

If a Bluetooth compatible mobile phone, portable player, etc. is connected by wireless, you can play back a song (operation is controllable from the unit).

- Operation may vary, depending on the Bluetooth compatible device.

Bluetooth Audio main screen example



Function mode



- ① Current track no./Total song no.
- ② Artist title
- ③ Song title
- ④ Album title
- ⑤ Elapsed time
- ⑥ Touch or swipe to the right to use the Quick Search mode and Full Search mode.

Quick Search mode screen example

Swipe vertically in the list to change pages.



- ⑦ Full Search button
Swipe to the right when using Full Search mode.
- The displayed onscreen buttons may differ depending on the AVRCP version.
 - Song title/Artist title/Album title/Elapsed time do not display for AVRCP Ver. 1.0.

- To play back audio, a mobile phone or a portable player conforming to A2DP (Advanced Audio Distribution Profile) or AVRCP (Audio/Video Remote Control Profile) is required.
- Not all functions work with all devices.
- During a call, sound on the Bluetooth audio source is paused.

Compatible AVRCP versions: 1.0, 1.3, 1.4, 1.5

- Available functions may differ depending on the AVRCP version.

Playback

1 Press the (AUDIO) button to select Bluetooth Audio mode.

The display shows the Bluetooth Audio mode screen.

- You can also select and change the source in the Menu screen (page 21) or the Favorite screen (page 24).

2 Touch [] or [] to select the desired track (file).

Returning to the beginning of the current file:

Touch [].

Fast backward the current file:



Touch and hold [].

Advance to the beginning of the next file:

Touch [].

Fast forward the current file:

Touch and hold [].

- The  and  buttons provide the same functions above.

3 To pause playback, touch [/III].

Repeat Play

Available for AVRCP Ver. 1.3, 1.4 and 1.5 only.

1 Touch [].

The Repeat mode select pop up screen is displayed.

- [] displays the currently selected mode.

2 Select your desired Repeat mode.

The selected Repeat mode changes the button.

All Track : Once all of the songs have finished playing, play back is repeated, starting with the first song.

Group : Only files in a group are repeatedly played back.

Single Track : Only the track currently playing is repeatedly played back.

Off : Repeat mode Off.

- Operations may differ depending on the connected Bluetooth compatible device.

Random Play

Available for AVRCP Ver. 1.3, 1.4 and 1.5 only.

1 Touch [].

The Random Play mode select pop up screen is displayed.

- The [] button displays the currently selected mode.

2 Select your desired Random Play mode.

The selected Random Play mode changes the button.

All Track : All songs in the Bluetooth compatible devices are played back in random sequence. Any one song does not play back again until all songs have been played back.

Group : A Group is selected randomly and songs in the Group are played back in order. After all songs are played in the Group, the next Group is selected randomly.

Off : Random mode Off.

- Operations may differ depending on the connected Bluetooth compatible device.

Search Function

Available for AVRCP Ver. 1.4 and 1.5 only.

The displayed list differs with the connected Bluetooth device.

You can search for your desired song by using one of two modes; the Quick Search mode and the Full Search mode.

Quick Search mode

Touch your desired Group name or File name.

The selected Group*1 or file is played back.

*1 The first file in the selected Group is played back.

- To switch into Quick Search mode, see ⑥ in "Bluetooth Audio main screen example" (page 84).

Full Search mode

Touch your desired Group name*2 or File name.

When you select a File name, the selected song is played.

When you select a Group name, repeat the same procedure to select another Group name or File name.

*2 When you touch the [] by a Group name, the unit plays from the first song in the Group.

- To switch into Full Search mode, see ⑦ in "Quick Search mode screen example" (page 84).
- To switch the displayed list or return to the previous page in the List screen, see "About Basic Operation for List Screen" (page 18).

Connecting a Bluetooth Device

Registering a Bluetooth device in the unit enables automatic connection. If it does not connect automatically, run through the connection procedure again.



- 1 Touch [] (Settings).**
The Device Setting select pop up screen is displayed.
- 2 Touch [Reconnect].**
Bluetooth connection will start.

Disconnecting the Bluetooth Connection

- 1 Touch [] (Settings).**
The Device Setting select pop up screen is displayed.
- 2 Touch [Disconnect].**
The Bluetooth connection is disconnected.

Changing the connecting Bluetooth Device

If multiple Bluetooth devices are registered in this device, you can change the connection among the registered devices.

- 1 Touch [] (Settings).**
- 2 Touch [Change].**
- 3 Touch [] (Audio) or [] (Hands-free) of the selected device.**
The connection will transfer to the selected device.

Auxiliary Device (X108U/INE-W967HD only) (Optional)

Operating Auxiliary Devices (Optional)

To operate devices connected to the AUX terminals of the unit, follow the procedure described below.

- Set AUX to “On.” See “AUX Setup (X108U/INE-W967HD only)” (page 44).
- Depending on the connected unit, the onscreen buttons may not work, or their operation may differ.
- When the iDataLink module (sold separately) is connected, the Auxiliary (AUX) mode is not available.



WARNING

It is dangerous (and illegal in many states) for the driver to watch TV/video while driving the vehicle. The driver may be distracted from looking ahead and an accident could occur.

Install the unit correctly so that the driver cannot watch TV/video unless the car is stopped and the parking brake is applied.

If the unit is not installed correctly, the driver will be able to watch TV/video while driving and may be distracted from looking ahead and cause an accident. The driver or other people could be severely injured.

Press the  (AUDIO) button to select Auxiliary (AUX)* mode. The display shows the Auxiliary (AUX) mode screen.

* The name which is given as the mode name in “Setting the Auxiliary (AUX) Name” (page 45) is displayed.

- For your safety, video is not displayed and only audio can be heard while driving.
- You can select and change the source in the Menu screen (page 21) or Favorite screen (page 24).
- For details on the connected auxiliary device, refer to its owner’s manual.

AUX Operation Screen Display During Video File Playback

Touch the screen.

The Auxiliary (AUX) operation screen is displayed.

- The operation screen changes to the visual screen in the Auxiliary (AUX) mode for 5 seconds after an operation has been performed. To hide the Auxiliary (AUX) operation screen, touch the video display area.

Operating an AUX, AUX DVD, GAME or USB Player

- Example for AUX, AUX DVD, GAME, USB Player mode display



- 1  (Display Mode)

For details, see “Switching Display Modes (During Video File Play Back)” (page 60).

- You cannot operate them while driving.

Operating an External DVD Player

- External DVD player display example

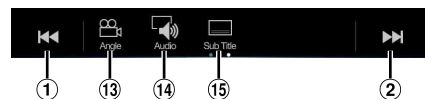
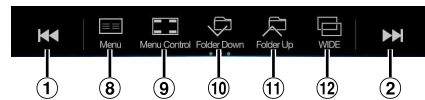
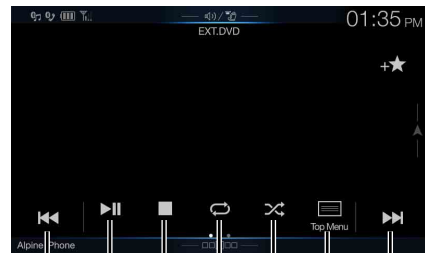

- 1 

Touch the switch to go back to the beginning of the current chapter/track/file. Touch the switch once more to find the beginning of the previous chapter/track/file. Touch and hold to fast reverse.

- 2 

Touch the switch to advance to the beginning of the next chapter/track/file. Touch and hold to fast forward.

- 3 

Switches between play and pause.

- 4 

Touching during play initiates a pre stop. Touching again stops play.

- 5 

Starts/Stop repeat play.

- 6 

Starts/Stop M.I.X. play.

- ⑦ [≡] (Top Menu)
Calls up the Top Menu screen.
- ⑧ [≡] (Menu)
Calls up the Menu screen.
- ⑨ [☰] (Menu Control)*
Calls up the menu operation mode.
- ⑩ [⇩] (Folder Down)
Switches the program/playlist/folder down.
- ⑪ [⇧] (Folder Up)
Switches the program/playlist/folder up.
- ⑫ [☰] (Display Mode)*
You can set the Display Mode. For details, see "Switching Display Modes (During Video File Play Back)" (page 60).
- ⑬ [∠] (Angle)
Switches angle.
- ⑭ [🔊] (Audio)
Switches audio.
- ⑮ [☰] (Sub Title)
Switches sub titles.

* You cannot operate them while driving.

■ Menu operation mode screen example

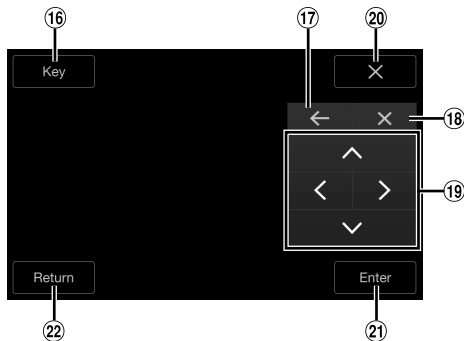

- ⑬ [Key]
Displays the Key panel (⑰ ⑱ ⑲).
- ⑰ [←], [→]
Moves key panel location.
- ⑱ [X]
Closes menu operation mode.
- ⑲ [X]
Closes key panel.
- ⑳ [∧], [∟], [∨], [>]
Moves menu cursor.
- ㉑ [Enter]
Determines the selected item.
- ㉒ [Return]
Returns to the previous item/screen.

Operating an External DVD Changer

The DVD Changer operation mode screen and the Menu operation mode screen are the same as the external DVD player operation screen. See "Operating an External DVD Player."

■ External DVD changer screen example



- ① [Disc1]-[Disc6]
Selects a Disc.
 - Touch the left side of the operation screen or swipe the operation screen to the right to display the Disc selection screen.

Operating the Mobile Digital TV Receiver (DVB-T)

■ Menu operation mode screen example

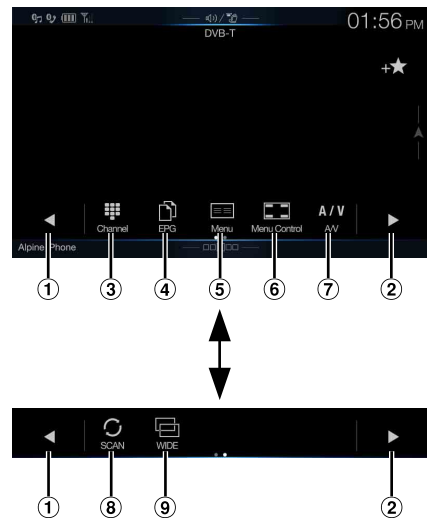

- ① [◀]
Switches the Channel number / Favorite channel number down.
- ② [▶]
Switches the Channel number / Favorite channel number up.
- ③ [📶] (Channel or Favorite)
Switches between the Channel mode and the Favorite channel mode.
- ④ [📺] (EPG)*
Call up the Electronic Program Guide (EPG).
- ⑤ [≡] (Menu)*
Call up the menu screen.
- ⑥ [☰] (Menu Control)*
Call up the menu operation mode.
- ⑦ [A/V] (A/V)
Switches the source.
- ⑧ [🔄] (Scan)
Touch the switch to start the scan procedure.
- ⑨ [☰] (Display Mode)
You can set the Display Mode. For details, see "Switching Display Modes (During Video File Play Back)" (page 60).

* You cannot operate them while driving.

Operating a TV

■ Menu operation mode screen example

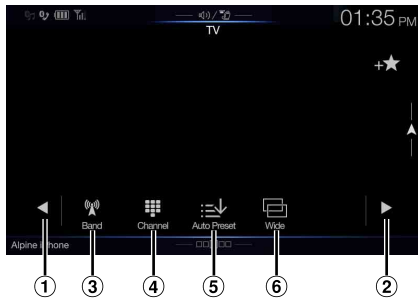

- ① [◀], [◀◀]
Switches the Channel number / Preset channel down.
- ② [▶], [▶▶]
Switches the Channel number / Preset channel up.
- ③ [📶] (Band)
Switches the band.
- ④ [📶] (Tune) (Channel or Preset or Manual)
Switches amongst Channel mode, Preset mode, and Manual mode.
- ⑤ [⏮] (Auto Preset)
The tuner automatically seeks and stores stations.
- ⑥ [📺] (Display Mode)*
You can set the Display Mode. For details, see "Switching Display Modes (During Video File Play Back)" (page 60).

* You cannot operate them while driving.

Camera Operation (Optional)

When an optional camera is connected, the view video of camera can be output to the monitor.

Front camera, Rear camera or Side camera can be connected to this unit. Make the Camera Select setting (Front, Rear, Side or Other) according to your connected camera. For details, see "Setting the Camera Input" (page 46).

When using the optional Multi Camera Interface module, you can connect up to 3 cameras: Front Camera, Rear Camera, and Side Camera. When connecting the optional Multi Camera Interface module, you need to set each camera to On/Off in "Setting Multi Camera to On/Off" (page 48).

When displaying the camera view while connected to the optional Multi Camera Interface module, you can switch the camera view using the switch button at the top of the screen.

Front camera:

When the HCE-C257FD is connected, conditions in front of the vehicle, such as objects, people and other hazards, can be seen.

Rear camera:

If an HCE-C127D/HCE-C157D/HCE-C252RD camera is connected, when the vehicle is reversed, the rear camera view (guide marks for vehicle width and available distance) is displayed automatically on the screen of this unit.

Side camera:

If the HCE-C259SD is connected, you can check for obstacles in the blind spot on the passenger side.

Other camera:

Set when connecting to a camera other than the Front camera or Rear camera, such as a room camera and side camera.

You can adjust the quality of the camera image.

Setting items: Brightness / Color / Contrast
See "Picture Quality Setup" (page 39).

Rear Camera Operation

Displaying the Rear Camera Image from the Menu screen

1 Press the MENU button.

The menu screen is displayed.



[Camera] button

- You can also display the menu screen by touching [□□□□□] on the lower part of the Audio source screen or by swiping upward.

2 Touch [Camera].

The Rear Camera view is displayed.

- Touch the screen while the camera image is being displayed, and touch [X] or [◀] to return to the main source screen or previous screen.
- You can perform a Guide Adjustment. For details, see "Adjusting the Rear/Front/Side Camera Guide" (page 46).
- If you connect a Front Camera and Side Camera using the optional Multi Camera Interface module, you can display the Rear camera image using the [Camera] button only when you set "Setting a Default Camera" (page 48) to "Rear". If you connect a Front Camera and Side Camera at the same time, touch [Front] or [Side] in the Rear Camera image to switch the Camera image.
- You can also switch the Camera view by Pressing  (CAMERA) button. (X110 only)

Displaying the rear view video while the car is in reverse

1 Shift the gear lever to the reverse (R) position.

The rear view image is displayed while the car remains in reverse.

2 If you shift the gear lever to a position other than reverse (R), the monitor returns to the previous screen.

- Never depend solely on the camera when backing up. Always turn and look and only use the camera for additional assistance.
- This function is effective when the reverse wire is properly connected.
- If you use the optional Multi Camera Interface module, be sure to set Rear Camera in "Setting Multi Camera to On/Off" (page 48) to "On" (☑). If setting to "Off" (☐), you cannot display the Rear camera image.
- If you set to Front or Side in "Setting a Default Camera" (page 48), the Rear camera image is also displayed.
- You can perform a Guide Adjustment. For details, see "Adjusting the Rear/Front/Side Camera Guide" (page 46).

Switching the Image Pattern for the Rear Camera

If the camera has a view switch function, the Direct Change switch is displayed.

1 Touch the screen when the image from the rear camera is displayed.

The operation screen is displayed on the screen.

- After a 5-second time-out, the operation screen returns to the camera display screen.

2 Touch [Back], [Panorama], [Corner] or [Top].

The image pattern changes.

[Back]: Rear View
[Panorama]: Panorama View
[Corner]: Corner View
[Top]: Ground View

- For detailed information about image patterns, see the camera Owner's Manual.
- You can perform a Guide Adjustment. For details, see "Adjusting the Rear/Front/Side Camera Guide" (page 46).

Guide Display ON/OFF Setting

1 Touch the screen when the image from the camera is displayed.

The operation screen is displayed on the screen.

- After a 5-second time-out, the operation screen returns to the camera display screen.

- 2 Touch [Guide Off] or [Hitch Guide Off] on the Rear camera display screen.**
The guide disappears, and then the [Guide Off] or [Hitch Guide Off] switch changes to [Guide On] or [Hitch Guide On].

- 3 Touch [Guide On] or [Hitch Guide On] to turn on the guide.**

Adjusting the Caution Display Location

- 1 Touch the screen when the image from the camera is displayed.**

The operation screen is displayed on the screen.

- After a 5-second time-out, the operation screen returns to the camera display screen.

- 2 Touch [Caution].**

- For each touch, the caution location moves to the top or bottom of the screen.

About the Rear Camera Guide

To display the guide, set "Guide Display ON/OFF Setting" (page 90) to On. Also, to adjust the guide, see "Adjusting the Rear/Front/Side Camera Guide" (page 46). You can also turn off the guide in the Rear camera display screen.

■ Indication mark meaning

When the car is put into reverse gear, the monitor switches to the rear view camera image. Guides appear to help visualize the car's width and distance from the rear bumper.

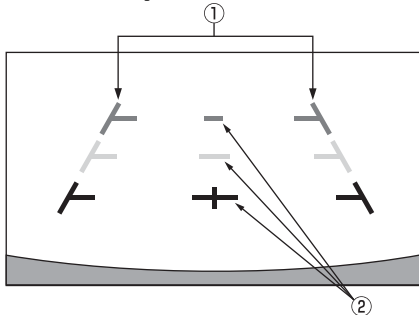

- ① Car width extension marks (red, yellow and green in order of distance)**

If properly calibrated, the marks indicate the car's width. This helps guide the car's path when backing up in a straight line.

The marks represent the distance from the rear of the car (from the rear end of the bumper).

- The marks do not move in synchronization with the steering wheel.
- Set the marks to suit the car's width.

- ② Distance guidance marks**

The marks represent the distance from the rear of the car (from the rear end of the bumper).

- The marks do not move in synchronization with the steering wheel.
- We recommend that you measure the actual distance to the marks when parked on a level surface.

- Depending on the condition of the car or road surface, the range of vision may vary.

- The camera has a limited range of vision. Objects at extreme angles to the camera (e.g. under the bumper or at opposite ends of the bumper) may not be in its field-of-vision.
- The rear camera image may have a tint which is different from the actual surroundings.
- Depending on the car, the guidance may deviate to the right or left. This is not a malfunction.

■ Distance guidance mark

The distance guides represent the ground level distance from the rear bumper. It is difficult to accurately estimate the distance to objects above ground level.

In the following example, the distance to A is 0.5 m and the distance to B is 1 m.

<Screen>

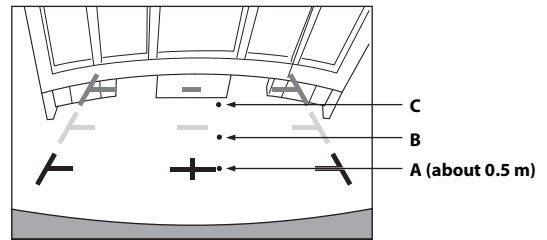

<Positions of A, B and C>

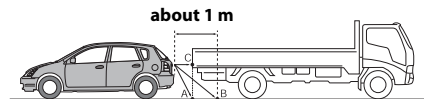

In the screen, according to the distance guidance marks, the truck seems to be parked about 1 m away (at the position B). In actual fact, however, if you reversed to position A, you would collide with the truck.

In the screen, positions A, B and C seem to be located in order of proximity. However, in actual fact, the position A and C are the same distance, and B is farther away than positions A and C.

- The car width extension mark represents the distance to the road surface. The distance to an object on the road is not accurately represented by the guides.

Error between the screen and the actual road surface

In the following conditions, errors are produced between the screen guidance and the actual road surface. (The illustrations represent a case when the camera is installed in the standard position.)

■ When there is a steep upward slope behind the car (example)

<Screen>

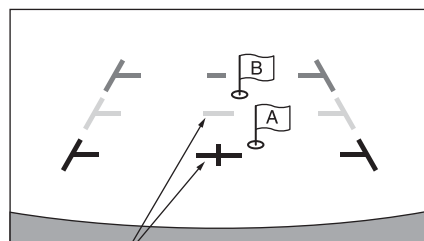

Distance guidance marks

<Situation of the car>

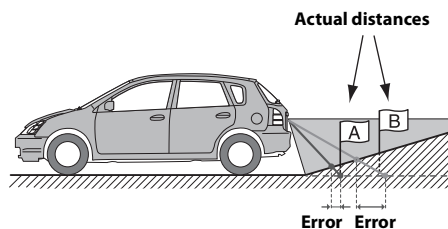

The distance guidance mark represents the distance to a flat road surface. Therefore in the case of an upward slope behind the car, the distance guides are displayed closer to the rear bumper than the actual distance. For example, if there is an obstacle on the upward slope, it may appear farther away than its actual position.

Also, an error may occur between the guidance and the actual path of the car on the road surface.

■ **When there is a steep downward slope behind the car (example)**

<Screen>

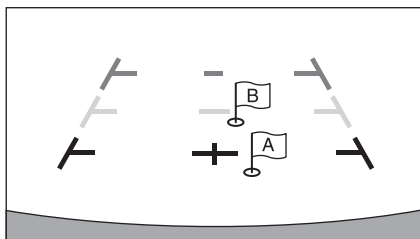

<Situation of the car>

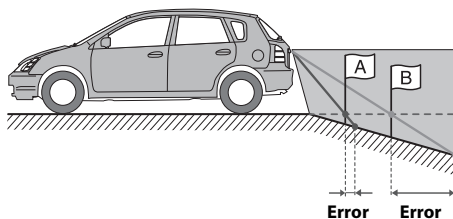

In the case of a downward slope behind the car, the distance guides are displayed farther from the rear bumper than the actual distance.

If there is an obstacle on the downward slope, it seems closer than its actual position.

Also, an error may occur between the guidance and the actual path of the car on the road surface.

Front Camera Operation

Displaying the Front Camera image from the Menu screen.

1 Press the MENU button.

The menu screen is displayed.



[Camera] button

- You can also display the menu screen by touching [□□□□] on the lower part of the Audio source screen or by swiping upward.

2 Touch [Camera].

The Front Camera view is displayed.

- Touch the screen while the camera image is being displayed, and touch [X] or [◀] to return to the main source screen or previous screen.
- You can perform a Guide Adjustment. For details, see "Adjusting the Rear/Front/Side Camera Guide" (page 46).
- If you connect a Front Camera using the optional Multi Camera Interface module, you can display the Front camera image using the [Camera] button only when you set "Setting a Default Camera" (page 48) to "Front". If you connect a Rear Camera and Side Camera at the same time, touch [Rear] or [Side] in the Rear Camera image to switch the Camera image.
- You can also switch the Camera view by Pressing  (CAMERA) button. (X110 only)

Switching the Image Pattern for the Front Camera

If the camera has a view switch function, the Direct Change switch is displayed.

1 Touch the screen when the image from the front camera is displayed.

The operation screen is displayed on the screen.

- After a 5-second time-out, the operation screen returns to the camera display screen.

2 Touch [Panorama], [Corner] or [Top].

The image pattern changes.

[Panorama]: Panorama View

[Corner]: Corner View

[Top]: Ground View

- For detailed information about image patterns, see the camera Owner's Manual.
- You can perform a Guide Adjustment. For details, see "Adjusting the Rear/Front/Side Camera Guide" (page 46).

About the adjustment of guide display ON/OFF setting and adjustment of Caution display location

As with the rear camera, the front camera guide display ON/OFF setting and Caution display location can be adjusted. See “Guide Display ON/OFF Setting” (page 90) and “Adjusting the Caution Display Location” (page 91) for the operations.

Side Camera Operation

Displaying the Side Camera image from the Menu screen.

1 Press the MENU button.

The menu screen is displayed.



[Camera] button

- You can also display the menu screen by touching [□□□□□] on the lower part of the Audio source screen or by swiping upward.

2 Touch [Camera].

The Side Camera view is displayed.

- Touch the screen while the camera image is being displayed, and touch [X] or [⏪] to return to the main source screen or previous screen.
- You can perform a Guide Adjustment. For details, see “Adjusting the Rear/Front/Side Camera Guide” (page 46).
- If you connect a Side Camera using the optional Multi Camera Interface module, you can display the Side camera image using the [Camera] button only when you set “Setting a Default Camera” (page 48) to “Side”. If you connect a Rear Camera and Front Camera at the same time, touch [Rear] or [Front] in the Rear Camera image to switch the Camera image.
- You can also switch the Camera view by Pressing  (CAMERA) button. (X110 only)

Switching the Image Pattern for the Side Camera

If the camera has a view switch function, the Direct Change switch is displayed.

1 Touch the screen when the image from the side camera is displayed.

The operation screen is displayed on the screen.

- After a 5-second time-out, the operation screen returns to the camera display screen.

2 Touch [Rear] or [Front].

The image pattern changes.

Rear: Vehicle Rear view
Front: Vehicle Front view

- For detailed information about image patterns, see the camera Owner's Manual.
- You can perform a Guide Adjustment. For details, see “Adjusting the Rear/Front/Side Camera Guide” (page 46).

iDataLink Operation



When the unit is connected to the car's iDataLink module, you can transfer and receive data between the car and the unit to check the car's status, or to make various operations from the unit.

When you use iDataLink mode, set each setting other than "Aftermarket" in "Setting the Source Category" (page 48).

- For X108U/INE-W967HD, an iDataLink module (sold separately) is required.
- Available functions differ depending on your vehicle. For details, refer to your vehicle's instruction manual.

About Audio Interrupt

Audio Interrupt is the function that outputs sound from the unit when Voice Information (audio reading from the phone book, etc.)* from the vehicle occurs.

- The Audio Interrupt function of the vehicle differs depending on the type and grade of the vehicle.
- * For your safety, when interrupted with Voice Information, you cannot operate the buttons on the front panel or the touch buttons on the display, except for some operations.
 - The operating restrictions may differ depending on which mode the unit is in during Voice Information.
 - You can use the  (CAMERA) button to display the camera view and switch the image pattern while the camera image is being displayed.
 - You can use the  (MUTE) button or the  (DOWN/UP) button to control the volume of Voice Information.
 - Operation of the Remote Control unit (supplied with the DVD Player or sold separately) is also restricted.

Access to iDataLink Mode

You can check the car's status, set the air conditioning, etc.

- 1 Press and hold the  (Favorite) button for at least 2 seconds, or touch  (Vehicle Info.) in the Menu screen to activate iDataLink mode.**

- The iDataLink mode screen selected in "Setting the Default Vehicle Screen" (page 48) is displayed.

- 2 Touch the desired tag on the top of the screen.**

Select item:

Climate / Gauges / Park Sensor / Vehicle Info. / Car Setting

- The displayed tag options differ depending on the type of vehicle.

■ Climate screen example

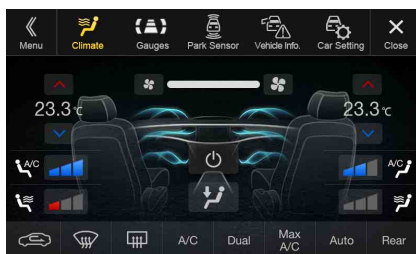

3 Adjust or confirm the item/information accordingly.

- Operable functions and displays may differ depending on the vehicle.

iDataLink Function Screen example

■ Climate screen example

You can control the temperature inside the vehicle, etc.

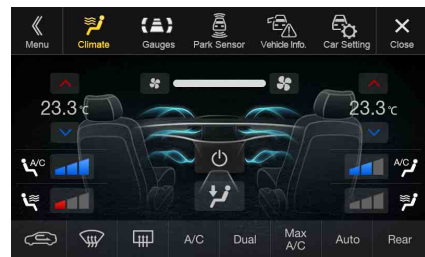

■ Gauges screen example

You can check the vehicle's speed, the engine's rotation speed, etc.



■ Parking sensor screen example

You can check the distance from the front and rear of the vehicle to an obstacle.

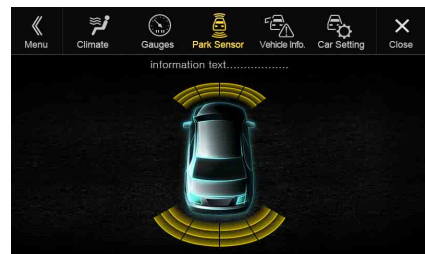

- If the car sensor detects an obstacle, the screen automatically changes to the Parking sensor screen. For details, see "About Parking Sensor screen" (page 95).

■ Vehicle Information screen example

You can check for open doors, check the tire pressure, the battery life, etc. for the vehicle.



■ Car Setting screen example (Generic List screen)

The Generic List/Popup Window/Current source control screen is displayed.

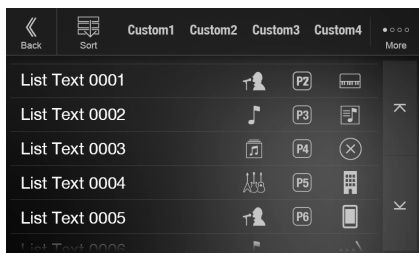

Parking Sensor Camera interlock screen example (Rear camera)

You can check for obstacles through an interlocked camera image by connecting a Front or Rear Camera.

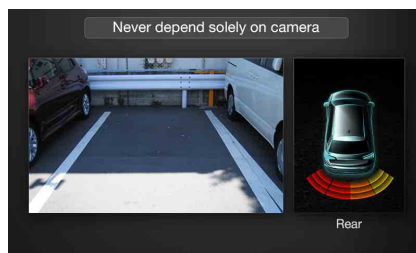

- Touch the Camera image area to switch to the Camera full screen. (While displaying the Camera full screen, touch the Camera screen, then touch [Sensor] to return to the Parking Sensor Camera interlock screen.)
- Touch the car icon to switch to the Parking sensor full screen. (Touch [⏪] on the Parking Sensor full screen to return to the Parking Sensor Camera interlock display.)
- To use this function, set the Camera Select setting to "Front/Other" or "Rear." For details, see "Setting the Camera Input" (page 46).
- If you connect a Front Camera/Rear Camera/Side Camera using the optional Multi Camera Interface module, you can switch the Camera display. For details on the camera settings when connected to the Multi Camera Interface module, see "Setting Multi Camera to On/Off" (page 48). For details on how to switch the camera display, see "Camera Operation (Optional)" (page 90).

About Parking Sensor screen

The Parking sensor screen turns on when the front or rear sensor on your vehicle detects an obstacle within a certain distance.

Parking Sensor Full screen example

When the front or rear sensor detects an obstacle within a certain distance, the Parking Sensor screen is displayed, and the indicator (① - ⑧) that corresponds with that area lights up.

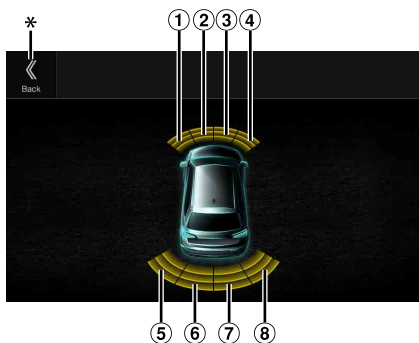

Indicator colors when an obstacle is detected.

Red: close distance
Orange: medium distance
Yellow: long distance

- Depending on the speed of the vehicle, when moving faster than a certain speed, the Parking Sensor screen may not be displayed.
- Vehicles that do not have the obstacle detection sensor cannot use this function.

* [⏪] is displayed only when the Front camera or Rear camera is interlocked.

External Accessory Control Operation

You can set the headlights to ON/OFF or adjust the air suspension from this unit by connecting the optional External Accessory Control module.

- In order to keep external accessory control outputs on during the ignition cycle, please change "Accessory During Crank" to "On". Otherwise all switches will be turned off.
[Setup] → [System] → [Factory System Setup] → [Maestro Module] → [Maestro Features] → [Maestro Module] → [Accessory During Crank] → "On"

The following explains how to edit the control switches, because the functions that can be controlled differ depending on the type of vehicle.

You cannot edit the External Accessory screen while driving.

Your vehicle must be parked with the ignition key in the ACC or ON position. For details, see "To display the Setup Menu screen" in "Setup Operation" (page 29).

1 Touch [] (Ext Acc Ctrl) in the Menu screen to activate External Accessory screen.

The External Accessory screen is displayed.



2 Touch [] (Edit).

The Edit Control Switches screen is displayed.



3 Edit each switch.

When changing an icon:

Touch the icon, and select your desired icon from the Icon Type list. After selecting the icon, set the Output Type (Timing) for each function.

* The Output Type (Timing) sets the operating time for that function when you touch the icon on the External Accessory screen.

Pulse: The operating time when you touch the icon. (Select from 11 steps, ranging 0.5 sec. to 10 sec.)

Latch: Switch On/Off by touching the icon.

Momentary: Operating time lasts from when an icon is touched to when it is released.



When changing the name:

Touch the icon name, then input characters into Edit Name (Keypad). You can also select a basic name from the [Template] of the Keypad. For details on how to input characters using the keypad, see "How to Input Characters and Numbers (Keypad)" (page 23). (When a basic name is selected from the Template, the icon will be changed according to the basic name.)

When changing the layout of the switches:

Drag and drop an icon to the desired location.

To revert to a default icon:

Touch the check box "" of the icon that you want to revert to default, and then touch [] (Reset). If you touch [] (Reset All), all icons revert to default icons.

4 After editing is complete, touch [] (Back).

5 After the caption for the confirmation is displayed, touch [].

- If you touch [] (Cancel) while editing, the edits are reset and the screen returns to the previous Edit screen.

About Remote Control Operation (X110 only)

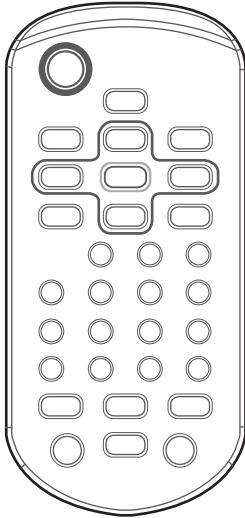

When Using the Remote Control

- When you first use the remote control, please remove the insulation sheet in the battery case.
- Point the remote control at the remote sensor within about 2 metres.
- It may not be possible to operate the remote control if the remote control sensor is exposed to direct sunlight.
- The remote control is a small, lightweight precision device. To avoid damage, short battery life, operational errors and poor response, observe the following.
 - Do not subject the remote control to excessive shock.
 - Do not put in a trouser pocket.
 - Keep away from food, moisture and dirt.
 - Do not place in direct sunshine.

Battery Replacement

Battery type: CR2025 battery or equivalent.

1 Opening the battery case

Slide out the battery cover while firmly pressing in the direction of the arrow.

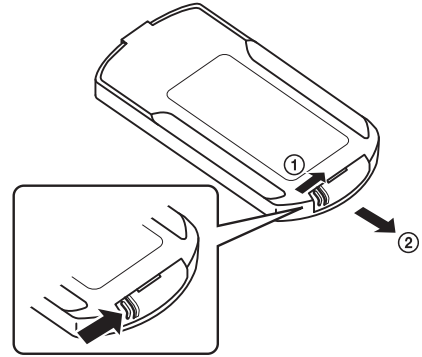

2 Replacing the battery

Put the battery in the case with the (+) indication upward as shown in the illustration.

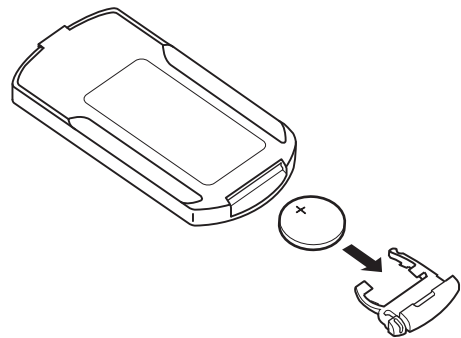

- Placing a battery in backwards way may cause a malfunction.

3 Closing the cover

Slide the cover as illustrated until a click is heard.

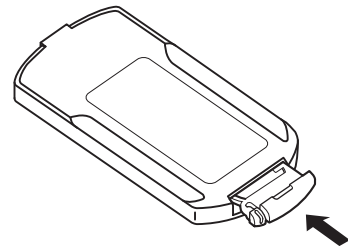

WARNING

DO NOT OPERATE ANY FUNCTION THAT TAKES YOUR ATTENTION AWAY FROM SAFELY DRIVING YOUR VEHICLE.

Any function that requires your prolonged attention should only be performed after coming to a complete stop. Always stop the vehicle in a safe location before performing these functions. Failure to do so may result in an accident.

Operating the DVD Player

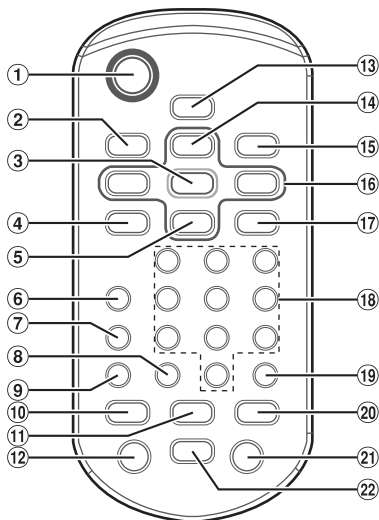

- ① **⏪ button**
Recalls the Menu screen.
- ② **DISP. button**
Displays playback status on the screen.
- ③ **ENT. button**
Determines the selected item.
- ④ **REPEAT button**
Repeats playback.
- ⑤ **▼ button**
Selects MP3/WMA/AAC/WAV folders.
- ⑥ **AUDIO button**
Video CD: Switches the audio output.
DVD: Switches the audio language.
- ⑦ **SUBTITLE button**
Switches the subtitle.
- ⑧ **CLR (ALL CLR) button**
Removes numbers (one character at a time) that have been selected and input.
Press and hold for 2 seconds. All the characters which were selected and input are erased.
- ⑨ **ANGLE button**
Switches the angle (DVD only).
- ⑩ **⏮ button**
CD mode:
Press the button to go back to the beginning of the current track. Press and hold to fast reverse.
MP3/WMA/AAC/WAV mode:
Press the button to go back to the beginning of the current file. Press and hold to fast reverse.

DVD/Video CD mode:

- Move to the desired position on the disc.
- During playback, press and hold for more than 1 second to reverse the disc at double speed. Hold for more than 5 seconds to reverse the disc at 8 times the normal speed. Hold for more than 10 seconds to reverse the disc at 32 times the normal speed.
- The picture is reversed by one frame each time the button is pressed in the pause mode (DVD only).

- ⑪ **▶/|| button**
Switches between play and pause.
- ⑫ **MENU button**
Video CD:
Switches between PBC ON and OFF.
DVD:
Displays the DVD menu.
- ⑬ **SETUP button**
Displays the SETUP (initial setting) screen.
- ⑭ **▲ button**
Selects MP3/WMA/AAC/WAV folders.
- ⑮ **RETURN button**
Returns to the selection screen just prior to the current screen.
- ⑯ **▼, ▲, ◀, ▶ buttons**
Selects the items displayed on the screen.
- ⑰ **M.I.X. button**
M.I.X. play for CDs and MP3/WMA/AAC/WAV.
- ⑱ **Numeric Keypad**
Inputs numbers.
- ⑲ **LIST button**
MP3/WMA/AAC/WAV Folder and File Search.
- ⑳ **▶▶▶ button**
CD mode:
Press the button to advance to the beginning of the next track. Press and hold to fast forward.
MP3/WMA/AAC/WAV mode:
Press the button to advance to the beginning of the next file. Press and hold to fast forward.
DVD/Video CD mode:
 - Move to the desired position on the disc.
 - During playback, press and hold for more than 1 second to forward the disc at double speed. Hold for more than 5 seconds to forward the disc at 8 times the normal speed. Hold for more than 10 seconds to forward the disc at 32 times the normal speed.
 - The picture is forwarded by one frame each time the button is pressed in the pause mode.
- ㉑ **TOP M. button**
Displays the Top Menu.
- ㉒ **■ button**
Stops the playback.

Information

Product Software Update

This product use software that can be updated through a USB flash drive. Download the software from the Alpine website and update the product using the USB flash drive.

Updating this product

Check the Alpine website for details on updating.

<http://www.alpine-usa.com>

Important information on the software

About the software license of the product

The software installed in the product contains open-source software. See the following Alpine website for details on the open source software.

<http://www.alpine.com/e/oss/download>

Cautions about Discs (X110 only)

Moisture Condensation

You may notice the disc playback sound wavering due to condensation. If this happens, remove the disc from the player and wait about an hour for the moisture to evaporate.

Damaged Disc

Do not attempt to play cracked, warped, or damaged discs. Playing a bad disc could severely damage the playback mechanism.

Never Attempt the Following

Do not grip or pull out the disc while it is being pulled back into the player by the automatic reloading mechanism.

Do not attempt to insert a disc into the unit when the unit power is off.

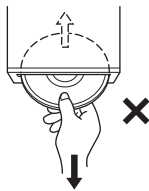

Inserting Discs

Your player accepts only one disc at a time for playback. Do not attempt to load more than one disc.

Make sure the label side is facing up when you insert the disc. "Disc error" will be displayed on your player if you insert a disc incorrectly. If "Disc error" continues to be displayed even though the disc has been inserted correctly, push the RESET switch with a pointed object such as a ballpoint pen.

Playing a disc while driving on a very bumpy road may result in skips, but this will not scratch the disc or damage the player.

Irregular Shaped Discs

Be sure to use round shaped discs only for this unit and never use any special shaped discs.

Use of special shaped discs may cause damage to the mechanism.



New Discs

To prevent the disc from jamming, "Disc error" is displayed if discs with irregular surfaces are inserted or if discs are inserted incorrectly. When a new disc is ejected immediately after initial loading, use your finger to feel around the inside of the center hole and outside edge of the disc. If you feel any small bumps or irregularities, this could inhibit proper loading of the disc. To remove the bumps, rub the inside edge of the hole and outside edge of the disc with a ballpoint pen or other such instrument, then insert the disc again.

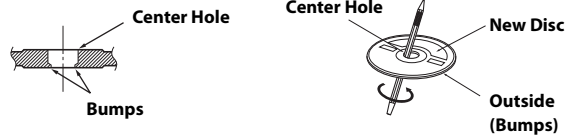

Installation Location

Make sure the unit will not be installed in a location subjected to:

- Direct sun and heat
- High humidity and water
- Excessive dust
- Excessive vibrations

Correct Handling

Do not drop the disc while handling. Hold the disc so you will not leave fingerprints on the surface. Do not affix tape, paper, or gummed labels to the disc. Do not write on the disc.

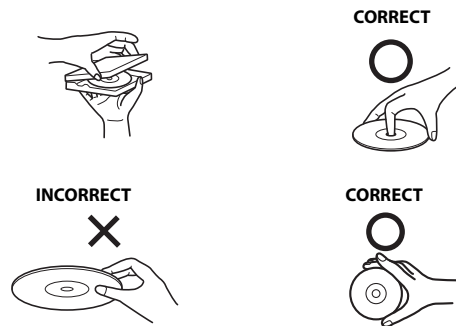

Disc Cleaning

Fingerprints, dust, or soil on the surface of the disc could cause the DVD player to skip. For routine cleaning, wipe the playing surface with a clean, soft cloth from the center of the disc to the outer edge. If the surface is heavily soiled, dampen a clean, soft cloth in a solution of mild neutral detergent before cleaning the disc.



Disc Accessories

There are various accessories available on the market for protecting the disc surface and improving sound quality. However, most of them will influence the thickness and/or diameter of the disc. Using such accessories can cause operational problems. We recommend not using these accessories on discs played in Alpine DVD players.

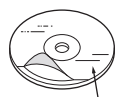

Transparent Sheet

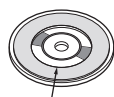

Disc Stabiliser

Discs Playable on This Unit (X110 only)

Playable Discs

The discs listed below can be played on this unit.

	Mark (logo)	Recorded Content	Disc size
DVD Video		Audio + Video	12 cm*
Music CD	 	Audio	12 cm
Video CD	 	Audio + Video	12 cm

* Two-layer DVD disc compatible

Discs that cannot be played

DVD-ROMs, DVD-RAMs, CD-ROMs (excluding MP3/WMA/AAC/WAV files), photo CDs, etc.

DualDisc

This unit is not compatible with DualDisc.

Using a DualDisc may cause unit malfunction, and may cause disc damage when the disc is inserted/ejected.

DVD region number (playable region number)

This DVD player will play back any disc whose region number is 2 (or All). DVDs with a region number other than those listed below, cannot be played on this DVD player.



Video CDs

This DVD unit is compatible with playback control (PBC) compatible video CDs (version 2.0).

“PBC” is a function by which you can use menu screens recorded on the disc to find the scene you want to watch and view various types of information in dialog style.

Using compact discs (CD/CD-R/CD-RW)

If you use unspecified compact discs, correct performance cannot be guaranteed.

You can play CD-Rs (CD-Recordables)/CD-RWs (CD-ReWritables) which have been recorded only on audio devices.

You can also play CD-Rs/CD-RWs containing MP3/WMA/AAC/WAV formatted audio files.

- Some of the following discs may not play on this unit:
 - Flawed discs, discs with fingerprints, discs exposed to extreme temperatures or sunlight (e.g., left in the car or this unit), discs recorded under unstable conditions, discs on which a recording failed or a re-recording was attempted, copy-protected CDs which do not conform to the audio CD industry standard.
- Use discs with MP3/WMA/AAC/WAV files written in a format compliant with this unit. For details, see pages 101 and 102.

To customers using CD-R/CD-RW

- If a CD-R/CD-RW cannot be played back, make sure the last recording session was closed (finalized).
- Finalize the CD-R/CD-RW if necessary, and attempt playback again.

Tips for making your own discs

The unit plays DVD Video, Video CD, Audio CD and has a built in MP3/WMA/AAC decoder.

The following information is designed to help you create your own music CDs (either Audio CD or MP3/WMA/AAC encoded CD-R/RW files).

What is the difference between an Audio and MP3/WMA/AAC CD?

An Audio CD is the same format as the commercial CDs you buy in the store (also known as CD-DA). MP3 (MPEG Audio Layer 3)/WMA (Windows Media Audio)/AAC (Advanced Audio Coding) is a data file that uses a compression scheme to reduce the size of the music file*.

* If the first session on a disc containing both CD-DA data and MP3/WMA/AAC data is a CD-DA file, only CD-DA files will be played.

Multisession CD-R/RW:

Once a recording has been stopped, this is considered one session. If the disc is not closed (finalized), additional data may be added. Once this additional data has been recorded, this becomes a “multisession” CD.

Properly formatted MP3/WMA/AAC Discs:

Use ISO9660 formatting to insure proper playback. You may use standard ISO naming Level 1 (8.3 DOS standard), Level 2 (32 characters) or Joliet (Windows or Macintosh long filenames) file naming conventions*.

* Please consult the Owner’s manual for additional information.

On handling compact discs (CD/CD-R/CD-RW)

- Do not touch the surface.
- Do not expose the disc to direct sunlight.
- Do not affix stickers or labels.
- Clean the disc when it is dusty.
- Make sure that the disc is smooth and flat.
- Do not use commercially available disc accessories.

Do not leave the disc in the car or the unit for a long time. Never expose the disc to direct sunlight.

Heat and humidity may damage the disc and you may not be able to play it again.

Using DVD-Rs/DVD-RWs/DVD+Rs/DVD+RWs

- This unit is compatible with discs recorded in the standard DVD-Video format.
- Note that discs not finalized (processed to enable to play on playback-only DVD players) cannot be played on this DVD player.
- Some discs may not play back, depending on the recording device and disc format.
- Discs or files utilising copy protection, may not be playable. Some recording systems may not properly format copied files to enable proper playback.
- In the following cases, the disc may not play on this unit: discs recorded by certain DVD recorders, certain irregular discs, flawed discs, dirty discs, when the pickup lens of this DVD player is dirty, or when moisture condensation has occurred inside the unit.
- Be sure to follow all cautions included with your DVD-Rs/DVD-RWs/DVD+Rs/DVD+RWs discs.
- Do not put stickers, seals, or tape on the label side of DVD-Rs/DVD-RWs/DVD+Rs/DVD+RWs.
- Compared to the regular discs, DVD-Rs/DVD-RWs/DVD+Rs/DVD+RWs are more affected by heat, moisture, and direct sunlight. If left in a car, etc., damage may occur and it might not play on this unit.
- The operable temperature range for disc playback is as follows:
DVD-R/DVD-RW: -25 to +70°C
DVD+R/DVD+RW: +5 to +55°C

About the Supported Formats

About MP3/WMA/AAC/FLAC



CAUTION

Except for private use, duplicating audio data (including MP3/WMA/AAC/FLAC data) or distributing, transferring, or copying it, whether for free or for a fee, without permission of the copyright holder is strictly prohibited by the Copyright Act and by international treaty.

What is MP3?

MP3, whose official name is "MPEG Audio Layer 3," is a compression standard prescribed by the ISO, the International Standardisation Organisation and MPEG which is a joint activity institution of the IEC.

MP3 files contain compressed audio data. MP3 encoding is capable of compressing audio data at extremely high ratios, reducing the size of music files to as much as one-tenth their original size. This is achieved while still maintaining near CD quality. The MP3 format realizes such high compression ratios by eliminating the sounds that are either inaudible to the human ear or masked by other sounds.

What is WMA?

WMA, or "Windows Media™ Audio," is compressed audio data. WMA is similar to MP3 audio data.

What is AAC?

AAC is the abbreviation for "Advanced Audio Coding," and is a basic format of audio compression used by MPEG2 or MPEG4.

What is FLAC?

FLAC (Free Lossless Audio Codec) is an audio file codec for lossless compression, developed and offered as open source software. Codecs with lossy compression forms, such as MP3 and AAC, reduce part of the data to improve compression efficiency. However, FLAC can reconstruct compressed data to be an identical copy of the original data by performing lossless compression. The compression ratio of FLAC is about 50%.

Method for creating MP3/WMA/AAC/FLAC (USB Flash drive) files

Audio data is compressed using software with MP3/WMA/AAC/FLAC (USB Flash drive) codecs. For details on creating MP3/WMA/AAC/FLAC (USB Flash drive) files, refer to the user's manual for that software.

MP3/WMA/AAC/FLAC (USB Flash drive) files that are playable on this device have the file extensions.

MP3: "mp3"

WMA: "wma"

AAC: "m4a"

FLAC: "flac"/"fla"

WMA is not supported for the following files, Windows Media Audio Professional, Windows Media Audio 10 std or Windows Media Audio 10 Pro Lossless.

There are many different versions of the AAC format. Confirm that the software being used conforms to the acceptable formats listed above. It's possible that the format may be unplayable even though the extension is valid.

Playback of AAC files encoded by iTunes is supported.

Supported playback sampling rates and bit rates

MP3 (USB Flash drive/Disc)

Sampling rates: 48 kHz, 44.1 kHz, 32 kHz, 24 kHz, 22.05 kHz, 16 kHz, 12 kHz, 11.025 kHz, 8 kHz

Bit rates: 8 - 320 kbps

WMA (USB Flash drive/Disc)

Sampling rates: 48 kHz, 44.1 kHz, 32 kHz, 22.05 kHz, 16 kHz, 11.025 kHz, 8 kHz

Bit rates: 48 - 320 kbps

AAC (USB Flash drive/Disc)

Sampling rates: 48 kHz, 44.1 kHz, 32 kHz, 24 kHz, 22.05 kHz, 16 kHz, 12 kHz, 11.025 kHz, 8 kHz

Bit rates: 16 - 320 kbps

FLAC (USB Flash drive)

Sampling rates: 96kHz, 88.2kHz, 48kHz, 44.1kHz, 32kHz, 24kHz, 22.05kHz, 16kHz, 8kHz

Channel number: 1ch, 2ch

This device may not play back correctly depending on sampling rates.

ID3 tags/WMA tags

This device supports ID3 tag v1.0, v1.1, v2.2, v2.3, v2.4, and WMA tag Ver.1.x. If tag data is in an MP3/WMA/AAC file, this device can display the title (track title), artist name, and album name ID3 tag/WMA tag data.

For non-supported characters, "?" is displayed.

The number of characters may be limited, or not correctly displayed, depending on the tag information.

Playing back MP3/WMA/AAC/FLAC

MP3/WMA/AAC files are prepared, then written to a USB flash drive.

- Maximum numbers of playable files/folders
USB Flash drive: 10,000 files/folders (including Root Folder)
- Largest playable file size: 512 MB

Playback may not be performed if a disc exceeds the limitations described above.

If a file/folder name is long, the maximum possible number of files may decrease.

- Both Audio and Video files are counted if their formats are playable on this unit.

Media supported

The media that this device can play back a USB flash drive.

Corresponding File Systems

This device supports FAT 16/32.

The maximum nested folder depth is 8 (including the root directory). File names are limited to 256 characters (including the extension).

Valid characters for folder/file names are letters A-Z (all caps), numbers 0-9, and '_' (underscore).

Order of files

Files are played back in the order that the writing software writes them to the disc. Therefore, the playback order may not be what's expected. Verify the writing order in the software's documentation. The playback order of the folders and files is as follows. (The following numbers may differ from actually displayed numbers.)

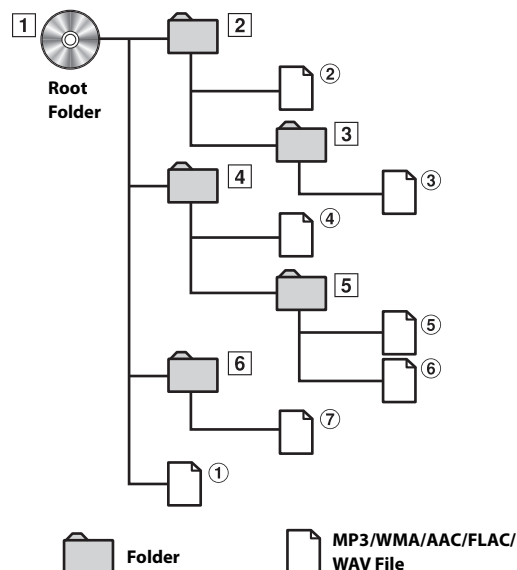

Terminology

Bit rate

This is the "sound" compression rate specified for encoding. The higher the bit rate, the higher the sound quality, but also the larger the files.

Sampling rate

This value shows how many times per second the data is sampled (recorded). For example, music CDs use a sampling rate of 44.1 kHz, so the sound is sampled (recorded) 44,100 times per second. The higher the sampling rate, the higher the sound quality, but also the larger the volume of data.

Encoding

Converting music CDs, WAVE (AIFF) files, and other sound files into the specified audio compression format.

Tag

Song information such as track titles, artist names, album names, etc., written into MP3/WMA/AAC/FLAC (USB flash drive) files.

Root folder

The root folder (or root directory) is found at the top of the file system. The root folder contains all folders and files. It is created automatically for all burned discs.

About WAV (Disc)

WAV, whose official name is "WAVE FORMAT" is a standard format of Windows® audio file.

Extension: ".wav"

Sampling rate: 44.1 kHz

Quantization bit number: 16

Channel number: up to 2ch

Format: PCM only

About DVDs

Music CDs and DVDs have grooves (tracks) in which the digital data is recorded. The data is represented as microscopic pits recorded into the track – these pits are read by a laser beam to play the disc. On DVDs, the density of the tracks and pits is twice that of CDs, so DVDs can contain more data in less space.

CDs

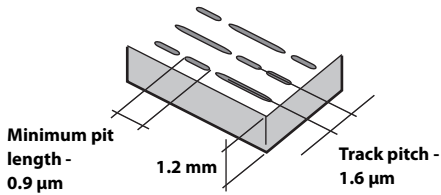

DVDs

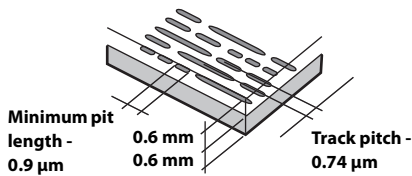

A 12 cm disc can contain one movie or about four hours of music. In addition, DVDs provide sharp picture quality with vivid colors thanks to a horizontal resolution of over 500 lines (compared to less than 300 for VHS tape).

In addition, DVDs offer a variety of functions.

Multiple audio* (page 77)

Movies can be recorded in up to eight languages. The desired language can be selected from the unit.

Subtitles function* (page 77)

Movies can include subtitles in up to 32 languages. The desired subtitle language can be selected from the unit.

Multi angle function* (page 77)

When the DVD contains a movie shot from multiple angles, the desired angle can be selected from the unit.

Multi story function*

With this function, a single movie includes various story lines. You can select different story lines to view various versions of the same movie. Operation differs from disc to disc. Story line selection screens including instructions appear during the movie. Just follow the instructions.

** These functions differ from disc to disc. For details, refer to the disc's instructions.*

List of Language Codes

(For details, see page 70.)

Abbreviation	Code	Language	Abbreviation	Code	Language	Abbreviation	Code	Language
AA	6565	Afar	IE	7369	Interlingue	RN	8278	Kirundi
AB	6566	Abkhazian	IK	7375	Inupiak	RO	8279	Romanian
AF	6570	Afrikaans	IN	7378	Indonesian	RU	8285	Russian
AM	6577	Amharic	IS	7383	Icelandic	RW	8287	Kinyarwanda
AR	6582	Arabic	IT	7384	Italian	SA	8365	Sanskrit
AS	6583	Assamese	IW	7387	Hebrew	SD	8368	Sindhi
AY	6589	Aymara	JP	7465	Japanese	SG	8371	Sangho
AZ	6590	Azerbaijani	JL	7473	Yiddish	SH	8372	Serbo-Croatian
BA	6665	Bashkir	JW	7487	Javanese	SI	8373	Singhalese
BE	6669	Byelorussian	KA	7565	Georgian	SK	8375	Slovak
BG	6671	Bulgarian	KK	7575	Kazakh	SL	8376	Slovenian
BH	6672	Bihari	KL	7576	Greenlandic	SM	8377	Samoan
BI	6673	Bislama	KM	7577	Cambodian	SN	8378	Shona
BN	6678	Bengali, Bangla	KN	7578	Kannada	SO	8379	Somali
BO	6679	Tibetan	KO	7579	Korean	SQ	8381	Albanian
BR	6682	Breton	KS	7583	Kashmiri	SR	8382	Serbian
CA	6765	Catalan	KU	7585	Kurdish	SS	8383	Siswati
CO	6779	Corsican	KY	7589	Kirghiz	ST	8384	Sesotho
CS	6783	Czech	LA	7665	Latin	SU	8385	Sundanese
CY	6789	Welsh	LN	7678	Lingala	SV	8386	Swedish
DA	6865	Danish	LO	7679	Laothian	SW	8387	Swahili
DE	6869	German	LT	7684	Lithuanian	TA	8465	Tamil
DZ	6890	Bhutani	LV	7686	Latvian, Lettish	TE	8469	Telugu
EL	6976	Greek	MG	7771	Malagasy	TG	8471	Tajik
EN	6978	English	MI	7773	Maori	TH	8472	Thai
EO	6979	Esperanto	MK	7775	Macedonian	TI	8473	Tigrinya
ES	6983	Spanish	ML	7776	Malayalam	TK	8475	Turkmen
ET	6984	Estonian	MN	7778	Mongolian	TL	8476	Tagalog
EU	6985	Basque	MO	7779	Moldavian	TN	8478	Setswana
FA	7065	Persian	MR	7782	Marathi	TO	8479	Tonga
FI	7073	Finnish	MS	7783	Malay	TR	8482	Turkish
FJ	7074	Fiji	MT	7784	Maltese	TS	8483	Tsonga
FO	7079	Faroese	MY	7789	Burmese	TT	8484	Tatar
FR	7082	French	NA	7865	Nauru	TW	8487	Twi
FY	7089	Frisian	NE	7869	Nepali	UK	8575	Ukrainian
GA	7165	Irish	NL	7876	Dutch	UR	8582	Urdu
GD	7168	Scots Gaelic	NO	7879	Norwegian	UZ	8590	Uzbek
GL	7176	Galician	OC	7967	Occitan	VI	8673	Vietnamese
GN	7178	Guarani	OM	7977	(Afan) Oromo	VO	8679	Volapuk
GU	7185	Gujarati	OR	7982	Oriya	WO	8779	Wolof
HA	7265	Hausa	PA	8065	Punjabi	XH	8872	Xhosa
HI	7273	Hindi	PL	8076	Polish	YO	8979	Yoruba
HR	7282	Croatian	PS	8083	Pashto, Pushto	ZH	9072	Chinese
HU	7285	Hungarian	PT	8084	Portuguese	ZU	9085	Zulu
HY	7289	Armenian	QU	8185	Quechua			
IA	7365	Interlingua	RM	8277	Rhaeto-Romance			

In Case of Difficulty

If you encounter a problem, please turn the power off, then on again. If the unit is still not functioning normally, please review the items in the following checklist. This guide will help you isolate the problem if the unit is at fault. Otherwise, make sure the rest of your system is properly connected, or then consult your authorized Alpine dealer.

Basic

No function or display.

- Vehicle's ignition is off.
 - If connected according to the instructions, the unit will not operate with the vehicle's ignition off.
- Improper power lead connections.
 - Check power lead connections.
- Blown fuse.
 - Check the fuse on the battery lead of the unit; replace with the proper value if necessary.
- Internal micro-computer malfunctioned due to interference noise, etc.
 - Press the RESET switch with a ballpoint pen or other pointed article.

No sound or unnatural sound.

- Incorrect setting of volume/balance/fader controls.
 - Readjust the controls.
- Connections are not properly or securely made.
 - Check the connections and firmly connect.

Screen not displayed.

- Brightness/Contrast control is set at the minimum position.
 - Adjust the Brightness/Contrast control.
- Temperature in the vehicle is too low.
 - Increase the vehicle's interior temperature to operation temperature range.
- Connections to the Auxiliary Device are not securely made.
 - Check the connections and firmly connect.
- The Parking Brake Lead is not connected.
- The Parking Brake is not engaged.
 - Connect the Parking Brake Lead, then engage the Parking Brake.

Movement of displayed picture is abnormal.

- Temperature in the vehicle is too high.
 - Allow the vehicle's interior temperature to cool.

The optional remote control is inoperative.

- The remote control sensor setting of "Remote Sensor Setting" (page 49) is not set to this unit ("Front").
 - Set for "Front".

Radio

Unable to receive stations.

- No antenna, or open connection in the antenna cable.
 - Make sure the antenna is properly connected; replace the antenna or cable if necessary.

Unable to tune stations in the seek mode.

- You are in a weak signal area.
 - Make sure the tuner is in DX mode.
- If the area you are in is a primary signal area, the antenna may not be grounded and connected properly.
 - Check your antenna connections; make sure the antenna is properly grounded at its mounting location.
- The antenna may not be the proper length.
 - Make sure the antenna is fully extended; if broken, replace the antenna with a new one.

Broadcast is noisy.

- The antenna is not the proper length.
 - Extend the antenna fully; replace it if it is broken.
- The antenna is poorly grounded.
 - Make sure the antenna is grounded properly at its mounting location.
- The station signal is weak and noisy.
 - If above solution does not work, tune in another station.

USB Audio

Unit does not operate.

- Condensation.
 - Wait a while (about 1 hour) for the condensation to dry.

Picture is unclear or noisy.

- Vehicle's battery power is weak.
 - Check the battery power and wiring.
(The unit may malfunction if the battery power is under 11 volts with a load applied.)

Rear Seat Entertainment System

DVD sound is not being output from the rear monitor headphones.

- The external audio processor and DVD Player (DVE-5300) are optically connected.
 - Set the Audio Out of the DVD Player to "LPCM."

Disc (X110 only)

Disc playback sound is wavering.

- Moisture condensation in the disc module.
 - Allow enough time for the condensation to evaporate (about 1 hour).

Disc insertion not possible.

- A disc is already in this unit.
 - Eject the disc and remove it.
- The disc is being improperly inserted.
 - Insert the disc correctly. (See page 69)

Unable to fast forward or backward the disc.

- The disc has been damaged.
 - Eject the disc and discard it; using a damaged disc in your unit can cause damage to the mechanism.

Disc playback sound skips due to vibration.

- Improper mounting of the unit.
 - Securely re-mount the unit.
- Disc is very dirty.
 - Clean the disc.
- Disc has scratches.
 - Change the disc.
- The pick-up lens is dirty.
 - Do not use a commercially available lens cleaner disc. Consult your nearest Alpine dealer.

Disc playback sound skips without vibration.

- Dirty or scratched disc.
 - Clean the disc; a damaged disc should be replaced.

CD-R/CD-RW/DVD-R/DVD-RW/DVD+R/DVD+RW playback not possible.

- Close session (finalization) has not been performed.
 - Perform finalization and attempt playback again.

Error displays.

- Mechanical error.
 - Press . After the error indication disappears, insert the disc again. If the above-mentioned solution does not solve the problem, consult your nearest Alpine dealer.

MP3/WMA/AAC is not played back.

- Writing error occurred. The CD format is not compatible.
 - Make sure the CD has been written in a supported format. Refer to “About MP3/WMA/AAC” (pages 101 to 102), then rewrite in the format supported by this device.

Unit does not operate.

- Condensation.
 - Wait a while (about 1 hour) for the condensation to dry.

Playback does not start.

- Disc is loaded upside-down.
 - Check the disc and load it with the labelled side facing upward.
- Disc is dirty.
 - Clean the disc.
- A disc not able to play back with this unit is loaded.
 - Check if the disc is able to be played back.
- Parental lock is set.
 - Cancel the parental lock or change the rating level.

Picture is unclear or noisy.

- Disc is being fast-forwarded or fast-reversed.
 - The picture may be slightly disturbed, but this is normal.
- Vehicle's battery power is weak.
 - Check the battery power and wiring.
(The unit may malfunction if the battery power is under 11 volts with a load applied.)

Image stops sometimes.

- Disc is scratched.
 - Replaced with a non-scratched disc.

Navigation

The Navigation cannot work properly.

- Reset Navigation system.
 - Turn the ignition key off, and then set to ON again.

If this Message Appears

Various messages are displayed on the screen during operation. In addition to the messages telling you the current status or providing guidance for the next operation, there are also the following error messages. If one of these error messages is displayed, carefully follow the instructions in the solution column.

System

If you are driving, please pull over and park before using this function.

- A setup operation, etc., was carried out while the vehicle was running.
 - Move the vehicle to a safe location, stop, and engage the parking brake, then carry out this operation.

Over-current detected on the USB.

- Abnormal current is run to the USB connector device.
 - Turn the ignition key off, and then set to ON again.
 - Attempt to connect another iPod/iPhone/USB Flash drive.

USB Hub is not supported.

- A USB flash drive with a hub is connected.
 - You cannot play back from a USB flash drive with a hub. USB hub connections are also not supported.

Audio/Visual

Connected USB Device is not compatible.

- An iPod/iPhone that is not supported by the unit is connected.
 - Connect an iPod/iPhone that is supported by the unit.
 - Reset the iPod.
- A USB device that is not supported by the unit is connected.
 - Attempt to connect another USB flash drive.
- Communication error.
 - Turn the ignition key off, and then set to ON again.
 - Check the display by reconnecting between the iPod/iPhone and the unit, using the iPod/iPhone cable.
 - Check the display by reconnecting between the USB flash drive and the unit.
- Caused by the iPod/iPhone Software Version not being compatible with this unit.
 - Update the iPod/iPhone Software Version to be compatible with this unit.
- The iPod/iPhone is not verified.
 - Change to another iPod/iPhone.

No data.

- There are no data in the iPod/iPhone.
 - Download data to the iPod/iPhone and connect to the unit.
- There are no data in the USB flash drive.
 - Download data to the USB flash drive and connect to this unit.

Un-readable song was skipped.

- A copy-protected WMA file has been detected.
 - You can only play back non-copy-protected files.
 - A sampling rate/bit rate not supported by the unit is used.
 - Use a sampling rate/bit rate supported by the unit.
-

Bluetooth

Please connect a Bluetooth audio device.

- The Bluetooth audio device was not connected correctly.
 - Check the settings for the unit and the Bluetooth audio device and reconnect.
-

Unable to download phonebook.

- Phonebook failed to read due to mobile phone disconnection, etc.
 - Check the mobile phone connection, and then conduct synchronizing and adding again. (See page 83)
 - The connected mobile phone does not support synchronizing of its phone book.
 - Connect the mobile phone that supports synchronizing the phone book, then synchronize again. (See page 83)
-

HDMI

HDMI communication error,

Please check your device and try again.

- Communication error.
 - Turn the ignition key off, and then set to ON again.
 - Check the display by reconnecting between the HDMI and the unit, using the HDMI cable.
 - Check the display by reconnecting between the HDMI device and the unit.
-

HDMI current error,

Please reconnect your device and try again.

- Abnormal current is run to the HDMI connector device.
 - Turn the ignition key off, and then set to ON again.
 - Disconnect the HDMI device from the unit, and then reconnect it.
-

HDMI monitor communication error.

Please check the connection or restart system.

- HDMI device communication error.
 - Turn the engine (ACC) OFF/ON. Or, check the HDMI cable where it connects to the HDMI monitor.
-

Too many monitors are connected to the HDMI output.

Please check the connection.

- More than 4 HDMI monitors are connected.
 - A cascade connection using more than 2 distributors is made.
 - Use one distributor and less than 4 HDMI monitors when connecting.
-

iDataLink

CAN Communication error

- Communication error.
 - Check the iDataLink module connection.
-

SiriusXM

Check Tuner

- The SiriusXM Tuner is disconnected or the unit is having trouble communicating with the Tuner.
 - Connect the Tuner or check the Tuner connection to the back of the unit.
-

Check Antenna

- The SiriusXM Satellite Radio antenna or cable is either damaged or not connected correctly to the SiriusXM Tuner.
 - Check that the SiriusXM antenna cable is connected to the SiriusXM Tuner and check that the antenna cable is not kinked or otherwise damaged. Replace the antenna if necessary.
-

No Signal

- The SiriusXM satellite signal is too weak at the current location.
 - Move the vehicle to a location with a clear view of the southern sky.
 - Make sure the Satellite Radio antenna is properly mounted and not obstructed by metal objects.
-

Channel <xxx> Not Subscribed

Call SiriusXM to Subscribe

- The active channel has become unsubscribed or the requested channel is not available in your subscription package.
 - Visit www.siriusxm.com for information on subscribing to this channel.
 - The unit will revert to the previous selected channel or to channel 1 automatically.
-

Channel <xxx> Not Available

- The active channel is no longer in the SiriusXM channel lineup or the user has entered an invalid channel number.
 - Visit www.siriusxm.com for information on the current channel lineup.
 - The unit will revert to the previous channel or to channel 1 automatically.
-

Subscription Updated

Press OK to Continue

- Your subscription has been updated.
 - Touch [OK] to clear this message.
-

Channel <xxx> Locked

- A locked channel is selected.
 - Input the passcode on the number keypad screen, see "Parental Lock Function" (page 68). If wrong passcode is input, "Incorrect Pass Code entered" will be displayed and the unit will revert to the previous channel.
-

Updating . . .

- The Featured Favorites channels are during updating.
-

Updating Teams, please wait

- While the Game table is during updating, the [Game Alert Setup] button in SiriusXM setup mode is touched.
-

Replay Memory Full

- Buffer for Replay is full.
-

Replay Memory Near Full

- Buffer for Replay will full within 11 seconds.
-

Applying Alpine Tunelt App





You can not use Sound App

Because External AP is on.

- “Setting the External Audio Processor” (page 49) is “On.”
 - When “External Audio Processor” (page 49) is set to “On,” you cannot perform Sound Tuning from the Alpine Tunelt App. Set “External Audio Processor” to “Off” to perform Sound Tuning from the Alpine Tunelt App.
-

(X110 only)

DISC ERROR

- Mechanism error.
 - 1) Press  and eject the disc.
 - If the disc does not eject, press  again for at least 3 seconds and eject the disc.
 - If the disc still does not eject, consult your Alpine dealer.
 - 2) When the error indication remains after ejecting, press  again.
 - If the error indication still does not turn off after pressing  a few times, consult your Alpine dealer.
-

LO-TEMP

- The temperature in the car is too low.
 - Raise the temperature in the car to normal temperature.
-

NO DISC

- No disc is inserted.
 - Insert a disc.
 - Although a disc is inserted, “NO DISC” is displayed and the unit does not start to play or eject the disc.
 - Remove the disc by pressing  again for at least 3 seconds.
-

REGIONAL CODE VIOLATION





- Disc does not match regional code number.
 - Load a disc that matches the regional code number.
-

HI-TEMP

- Protective circuit is activated at high temperature.
 - The indicator will disappear when the temperature returns to within operation range.
 - Leave the power OFF until the temperature decreases and then turn the power ON again.
-

LOADING ERROR

EJECT ERROR

- Mechanism error.
 - 1) Press  and eject the disc.
 - If the disc does not eject, press  again for at least 3 seconds and eject the disc.
 - If the disc still does not eject, consult your Alpine dealer.
 - 2) When the error indication remains after ejecting, press  again.
 - If the error indication still does not turn off after pressing  a few times, consult your Alpine dealer.
-

PROTECTED

- A copy-protected WMA file was played back.
 - You can only play back non-copy-protected files.
-

ILLEGAL FORMAT

- A disc with an unsupported region code or other copyright infringement has been inserted.
 - Change to another disc.
-

READ ERROR

- The unit cannot read a disc's TOC because the disc has many scratches or is very dirty.
 - Clean the dirty disc, and insert it again. Damaged discs should be replaced.
-

Navigation

The vehicle's position is erroneous.

- The GPS reception is poor.
 - Drive the vehicle in an area of good GPS reception to allow the unit to recalibrate itself. Move to a location where strong GPS reception is possible.
-

No operation

- Moisture condensation
 - Allow enough time for the condensation to evaporate (about 1 hour).
 - Ambient Temperature
 - Make sure the temperature inside the vehicle is between 0°C and 45°C (32°F and 113°F).
-

Specifications

MONITOR SECTION

Screen Size	10" (X110) 8" (X108U) 7" (INE-W967HD)
LCD Type	Transparent type TN LCD
Operation System	TFT active matrix
Number of Picture Elements	1,152,000 pcs. (800 × 480 × 3 (RGB))
Effective Number of Picture Elements	99% or more
Illumination System	LED

FM TUNER SECTION

Tuning Range	87.7 – 107.9 MHz
Mono Usable Sensitivity	9.3 dBf (0.8 μ V/75 ohms)
50 dB Quieting Sensitivity	13.5 dBf (1.3 μ V/75 ohms)
Alternate Channel Selectivity	80 dB
Signal-to-Noise Ratio	65 dB
Stereo Separation	35 dB
Capture Ratio	2.0 dB

AM TUNER SECTION

Tuning Range	531 – 1,602 kHz
Usable Sensitivity	25.1 μ V/28 dBf

USB SECTION

USB requirements	USB 2.0
Max. Power Consumption	1,500 mA (CDP Support)
USB Class	USB (Play From Device)/ USB (Mass Storage Class)
File System	FAT16/32
Number of Channels	2-Channels (Stereo)
Frequency Response*1	5 – 20,000 Hz (\pm 1 dB)
Total Harmonic Distortion	0.008% (at 1 kHz)
Dynamic Range	95 dB (at 1 kHz)
Signal-to-Noise Ratio	100 dB
Channel Separation	85 dB (at 1 kHz)

*1 Frequency response may differ depending on the encoder software/bit rate.

HDMI SECTION

Input Format	480p/VGA
Output Format	480p

GPS SECTION

GPS Reception frequency	1,575.42 \pm 1 MHz
GPS Reception sensitivity	-130 dB max.

Bluetooth SECTION

Bluetooth Specification	Bluetooth V3.0
Output Power	-2 dBm Ave. (Power class 2)
Profile	HFP (Hands-Free Profile) OPP (Object Push Profile) PBAP (Phone Book Access Profile) A2DP (Advanced Audio Distribution Profile) AVRCP (Audio/Video Remote Control Profile) SPP (Serial Port Profile)

GENERAL

Power Requirement	14.4 V DC (11–16 V allowable)
Operating temperature	-4°F to +140°F (-20°C to + 60°C)
Power Output	18 W RMS \times 4*2
*2 Primary amplifier ratings per CEA-2006 Standard	
	<ul style="list-style-type: none">• Power output: measured at 4 Ohms and \leq 1% THD+N• S/N: 80 dBA (reference: 1 W into 4 Ohms)
Weight	2.9 kg (6 lbs. 6 oz) (X108U) 2.7 kg (5 lbs. 15 oz) (INE-W967HD)
Audio output level	
	Preout (Front, Rear): 4V/10k ohms (max.) Preout (Subwoofer): 4V/10k ohms (max.)

- Due to continuous product improvement, specifications and design are subject to change without notice.
- The LCD panel is manufactured using an extremely high precision manufacturing technology. Its effective pixel ratio is over 99.99%. This means that there is a possibility that 0.01% of the pixels could be either always ON or OFF.

NOSE/CHASSIS SIZE

X110 is sized exclusively for a certain car model.

■ X108U

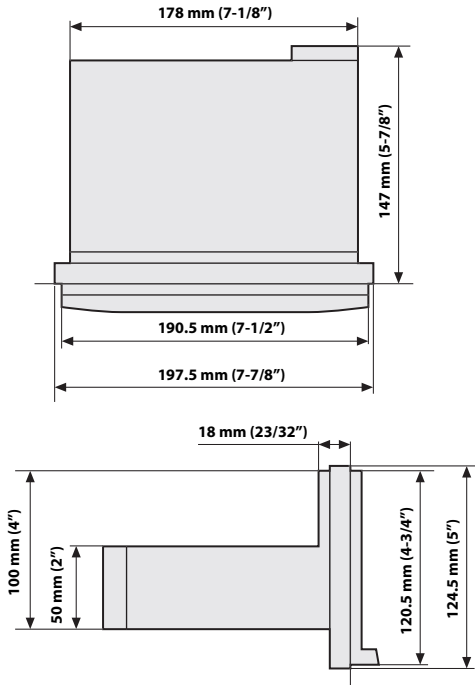

■ INE-W967HD

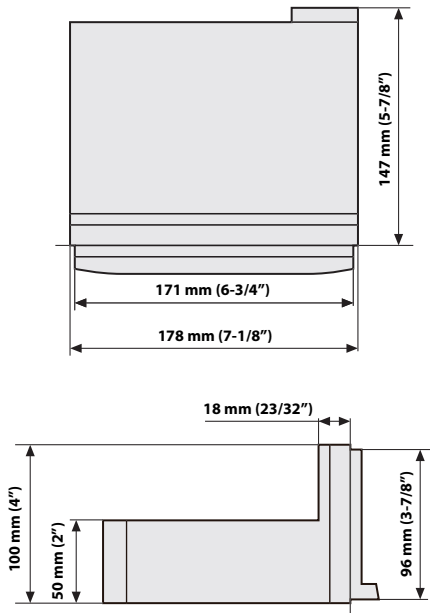

For X110

CD/DVD SECTION

Frequency Response	CD: 5 – 20,000 Hz (± 1 dB)
Wow & Flutter (% WRMS)	Below measurable limits
Total Harmonic Distortion	0.02 % (at 1 kHz)
Dynamic Range	95 dB (at 1 kHz)
Channel Separation	65 dB (at 1 kHz)
Horizontal resolution	500 lines or greater
Video output level	1Vp-p (75 ohms)
Video S/N ratio	DVD: 60 dB
Audio S/N ratio	95 dB

PICKUP

Wave length	DVD: 665 nm CD: 800 nm
Laser power	CLASS II

REMOTE CONTROL

Battery Type	CR2025 battery
Width	42 mm (1-11/16")
Height	90 mm (3-5/8")
Depth	11.6 mm (15/32")
Weight	50 g (2 oz) (battery excluded)

CAUTION-Laser radiation when open, DO NOT STARE INTO BEAM

(Bottom side of player)

END USER LICENSE AGREEMENT (HERE)

In using this Navigation System (hereinafter referred to as "System"), which includes Alpine Electronics, Inc. ("Alpine") Specifications, Space Machine, Inc. ("Space Machine") Software and HERE North America, LLC. ("HERE") Database, you are bound by the terms and conditions set forth below. By breaking the seal on the System and using your copy of the System, you have demonstrated your agreement to the terms and conditions of this Agreement. You should, therefore, make sure that you read and understand the following provisions.

The System may not be copied, duplicated or otherwise modified, in whole or in part, without the express written permission of Alpine, Space Machine and HERE.

The System may not be transferred or sublicensed to any third party for profit, rent or loan or licensed for reuse in any manner.

The System may not be decompiled, reverse engineered or otherwise disassembled, in whole or in part.

The System may not be used in a network or by any other manner of simultaneous use in multiple systems.

The System is intended solely for personal use (or internal use where the end-user is a business) by the consumer.

The System is not to be used for commercial purposes.

Neither Alpine, Space Machine nor HERE guarantees to the customer that the System meet the specific objectives of the user.

Neither Alpine, Space Machine nor HERE shall be responsible for any damages caused by the use of the System to the actual user and to any third party.

The warranty on the System shall not extend to an exchange or refund due to misspelling, omission of letters, or any other cosmetic discrepancy in layout found in the System.

The right to use the System shall expire either when the user destroys this software, or when any of the terms for use is violated and Alpine, Space Machine and/or HERE exercise the option to revoke the license to use this software.

The terms and conditions hereof apply to all subsequent users and owner's as well as to the original purchaser.

The HERE Database may include or reflect data of licensors, including Her Majesty The Queen in right of CANADA. Such data is licensed on an "AS IS" basis. The licensors, including Her Majesty The Queen, make no guarantees, representations or warranties respecting such data, either express or implied, arising by law or otherwise, accuracy or fitness for a particular purpose.

The licensors, including Her Majesty The Queen, shall not be liable in respect of any claim, demand or action, irrespective of the nature of the cause of the claim, demand or action alleging any loss, injury or damages, direct or indirect, which may result from the use or possession of the data or the HERE database. The licensors, including Her Majesty The Queen, shall not be liable in any way for loss of revenues or contracts, or any other consequential loss of any kind resulting from any defect in the data or the HERE database.

End User shall indemnify and save harmless the licensors, including Her Majesty The Queen and the minister, and their officers, employees and agents from and against any claim, demand or action, irrespective of the nature of the cause of the claim, demand or action, alleging loss, costs, expenses, damages or injuries (including injuries resulting in death) arising out of the use or possession of the data or the HERE database.



LIMITED WARRANTY

ALPINE ELECTRONICS OF AMERICA, INC. ("Alpine"), is dedicated to quality craftsmanship and is pleased to offer this Warranty. We suggest that you read it thoroughly. Should you have any questions, please contact your Dealer or contact Alpine at one of the telephone numbers listed below.

● PRODUCTS COVERED:

This Warranty covers Car Audio Products and Related Accessories ("the product"). Products purchased in the Canada are covered only in the Canada. Products purchased in the U.S.A. are covered only in the U.S.A.

● LENGTH OF WARRANTY:

This Warranty is in effect for one year from the date of the first consumer purchase.

● WHO IS COVERED:

This Warranty only covers the original purchaser of the product, who must reside in the United States, Puerto Rico or Canada.

● WHAT IS COVERED:

This Warranty covers defects in materials or workmanship (parts and labor) in the product.

● WHAT IS NOT COVERED:

This Warranty does not cover the following:

- ① Damage occurring during shipment of the product to Alpine for repair (claims must be presented to the carrier).
- ② Damage caused by accident or abuse, including burned voice coils caused by over-driving the speaker (amplifier level is turned up and driven into distortion or clipping). Speaker mechanical failure (e.g. punctures, tears or rips). Cracked or damaged LCD panels. Dropped or damaged hard drives.
- ③ Damage caused by negligence, misuse, improper operation or failure to follow instructions contained in the Owner's manual.
- ④ Damage caused by act of God, including without limitation, earthquake, fire, flood, storms or other acts of nature. Any cost or expense related to the removal or reinstallation of the product.
- ⑤ Service performed by an unauthorized person, company or association.
- ⑥ Any product which has the serial number defaced, altered or removed.
- ⑦ Any product which has been adjusted, altered or modified without Alpine's consent.
- ⑧ Any product not distributed by Alpine within the United States, Puerto Rico or Canada.
- ⑨ Any product not purchased from an Authorized Alpine Dealer.

● HOW TO OBTAIN WARRANTY SERVICE:

- ① You are responsible for delivery of the product to an Authorized Alpine Service Center or Alpine for repair and for payment of any initial shipping charges. Alpine will, at its option, repair or replace the product with a new or reconditioned product without charge. If the repairs are covered by the warranty, and if the product was shipped to an Authorized Alpine Service Center or Alpine, Alpine will pay the return shipping charges.
- ② You should provide a detailed description of the problem(s) for which service is required.

③ You must supply proof of your purchase of the product.

④ You must package the product securely to avoid damage during shipment. To prevent lost packages it is recommended to use a carrier that provides a tracking service.

● HOW WE LIMIT IMPLIED WARRANTIES:

ANY IMPLIED WARRANTIES INCLUDING FITNESS FOR USE AND MERCHANTABILITY ARE LIMITED IN DURATION TO THE PERIOD OF THE EXPRESS WARRANTY SET FORTH ABOVE AND NO PERSON IS AUTHORIZED TO ASSUME FOR ALPINE ANY OTHER LIABILITY IN CONNECTION WITH THE SALE OF THE PRODUCT.

● HOW WE EXCLUDE CERTAIN DAMAGES:

ALPINE EXPRESSLY DISCLAIMS LIABILITY FOR INCIDENTAL AND CONSEQUENTIAL DAMAGES CAUSED BY THE PRODUCT. THE TERM "INCIDENTAL DAMAGES" REFERS TO EXPENSES OF TRANSPORTING THE PRODUCT TO THE ALPINE SERVICE CENTER, LOSS OF THE ORIGINAL PURCHASER'S TIME, LOSS OF THE USE OF THE PRODUCT, BUS FARES, CAR RENTALS OR OTHERS COSTS RELATING TO THE CARE AND CUSTODY OF THE PRODUCT. THE TERM "CONSEQUENTIAL DAMAGES" REFERS TO THE COST OF REPAIRING OR REPLACING OTHER PROPERTY WHICH IS DAMAGED WHEN THIS PRODUCT DOES NOT WORK PROPERLY. THE REMEDIES PROVIDED UNDER THIS WARRANTY ARE EXCLUSIVE AND IN LIEU OF ALL OTHERS.

● HOW STATE/PROVINCIAL LAW RELATES TO THE WARRANTY:

This Warranty gives you specific legal rights, and you may also have other rights which vary from state to state and province to province. In addition, some states/provinces do not allow limitations on how long an implied warranty lasts, and some do not allow the exclusion or limitation of incidental or consequential damages. Accordingly, limitations as to these matters contained herein may not apply to you.

● IN CANADA ONLY:

This Warranty is not valid unless your Alpine car audio product has been installed in your vehicle by an Authorized Installation Center, and this warranty stamped upon installation by the installation center.

● HOW TO CONTACT CUSTOMER SERVICE:

Should the product require service, please call the following number for your nearest Authorized Alpine Service Center.

CAR AUDIO	1-800-ALPINE-1 (1-800-257-4631)
NAVIGATION	1-888-NAV-HELP (1-888-628-4357)

Or visit our website at: <http://www.alpine-usa.com>

ALPINE ELECTRONICS OF AMERICA, INC., 19145 Gramercy Place, Torrance, California 90501, U.S.A.

Do not send products to this address.

Call the toll free telephone number or visit the website to locate a service center.

About the Rules of Bluetooth Electromagnetic Radiation Regulation

USA/Canada	<p>FCC CAUTION Changes or modifications not expressly approved by the party responsible for compliance could void the user's authority to operate the equipment. This equipment complies with FCC/IC radiation exposure limits set forth for an uncontrolled environment and meets the FCC radio frequency (RF) Exposure Guidelines and RSS-102 of the IC radio frequency (RF) Exposure rules. This equipment has very low levels of RF energy that it deemed to comply without maximum permissive exposure evaluation (MPE). But it is desirable that it should be installed and operated keeping the radiator at least 20 cm or more away from person's body.</p> <p>Cet équipement est conforme aux limites d'exposition aux rayonnements énoncées pour un environnement non contrôlé et respecte les règles les radioélectriques (RF) de la FCC lignes directrices d'exposition et d'exposition aux fréquences radioélectriques (RF) CNR-102 de l'IC. Cet équipement émet une énergie RF très faible qui est considérée conforme sans évaluation de l'exposition maximale autorisée (MPE). Cependant, il est souhaitable qu'il devrait être installé et utilisé en gardant une distance de 20 cm ou plus entre le radiateur et le corps humain.</p>
México	La operación de este equipo está sujeta a las siguientes dos condiciones: (1) Este dispositivo no puede causar interferencia perjudicial, (2) este dispositivo debe aceptar cualquier interferencia recibida, incluyendo interferencia que puede ser causada por la operación no deseada del equipo (que puede causar un funcionamiento no deseado).

Don't forget to take a moment to protect your purchase by registering your product now at the following address: www.alpine-usa.com/registration.

N'oubliez pas de consacrer un moment à la protection de votre achat en enregistrant votre produit dès maintenant à l'adresse suivante : www.alpine-usa.com/registration.

Recuerde que con solo unos pocos pasos podrá proteger su producto, registrándolo a través de la siguiente dirección: www.alpine-usa.com/registration.