

# ALPINE®

## SYSTEM INTEGRATION AUDIO PROCESSOR

# PXA-H800



EN

FR

ES

- **OWNER'S MANUAL**  
Please read before using this equipment.
- **MODE D'EMPLOI**  
Veuillez lire avant d'utiliser cet appareil.
- **MANUAL DE OPERACIÓN**  
Léalo antes de utilizar este equipo.

**ALPINE ELECTRONICS MARKETING, INC.**  
1-1-8 Nishi Gotanda,  
Shinagawa-ku,  
Tokyo 141-0031, Japan  
Phone 03-5496-8231

**ALPINE ELECTRONICS OF AMERICA, INC.**  
19145 Gramercy Place, Torrance,  
California 90501, U.S.A.  
Phone 1-800-ALPINE-1 (1-800-257-4631)

**ALPINE ELECTRONICS OF CANADA, INC.**  
777 Supertest Road, Toronto,  
Ontario M3J 2M9, Canada  
Phone 1-800-ALPINE-1 (1-800-257-4631)

**ALPINE ELECTRONICS OF AUSTRALIA PTY. LTD.**  
161-165 Princes Highway, Hallam  
Victoria 3803, Australia  
Phone 03-8787-1200

**ALPINE ELECTRONICS GmbH**  
Wilhelm-Wagenfeld-Str. 1-3,  
80807 München, Germany  
Phone 089-32 42 640

**ALPINE ELECTRONICS OF U.K. LTD.**  
Alpine House  
Fletchamstead Highway, Coventry CV4 9TW, U.K.  
Phone 0870-33 33 763

**ALPINE ELECTRONICS FRANCE S.A.R.L.**  
(RCS PONTOISE B 338 101 280)  
98, Rue de la Belle Etoile, Z.I. Paris Nord II,  
B.P. 50016, 95945 Roissy Charles de Gaulle  
Cedex, France  
Phone 01-48638989

**ALPINE ITALIA S.p.A.**  
Viale C. Colombo 8, 20090 Trezzano  
Sul Naviglio (MI), Italy  
Phone 02-484781

**ALPINE ELECTRONICS DE ESPAÑA, S.A.**  
Portal de Gamarra 36, Pabellón, 32  
01013 Vitoria (Alava)-APDO 133, Spain  
Phone 945-283588

**ALPINE ELECTRONICS (BENELUX) GmbH**  
Leuvensesteenweg 510-B6,  
1930 Zaventem, Belgium  
Phone 02-725-13 15



# Contents

## Operating Instructions

### WARNING

<b>WARNING</b> .....	<b>4</b>
<b>CAUTION</b> .....	<b>4</b>
<b>NOTICE</b> .....	<b>4</b>

### Getting Started

How to Read this Manual .....	5
Location of Controls .....	6
PXA-H800 .....	6
Sound Manager for PXA-H800 .....	6
RUX-C800 Commander (sold separately) ....	7
Features .....	8
About Operating .....	8
About the Audio Setting .....	8
Before You First Use the Unit .....	8
Installing Sound Manager for PXA-H800 .....	9

## From a PC

### Basic Operation

Initial System Start-Up .....	10
Using with Ai-NET Connections .....	10
Turning Power On and Off .....	10
Operating the Sound Manager for PXA-H800	
Menu .....	10
Saving the Setup Data (File) .....	10
Loading the Setup Data (File) .....	10
Loading the ImprintEQ Measurement Data	
(File) .....	11
Downloading the Software (Option) .....	11
Viewing the Version Information	
(Option) .....	11
Audio Adjustment .....	11
Adjusting Fader	
(Between Front and Rear) .....	12
Adjusting Balance	
(Between Left and Right) .....	12
Adjusting Subwoofer (SubW Lv) .....	12
Adjusting Volume .....	12

Setting Defeat .....	12
Switching the Sources .....	12
Storing the Preset Values (Preset Store) .....	12
Recalling a Stored Setting (Preset Call) .....	13
Setting the Speaker System	
(Output System Select) .....	13
Setting the Speakers (Speaker Setup)/	
Setting the Subwoofers .....	14
Setting the AUX Input System	
(AUX Input System Select) .....	14
Setting and Adjusting the AUX Input/Digital	
Input (Analog AUX Input/Digital AUX	
Input) .....	15
Setting the AUX Input (AUX IN) .....	15
Setting the Digital Input (Digital AUX) .....	15
Setting the AUX Volume Input level	
(AUX IN Gain) .....	15
Adjusting the AUX Volume level	
(AUX Level) .....	15
Naming the AUX Input (AUX Name) .....	16
Setting/Adjusting the Navigation Guidance	
Volume (Navi Mix) .....	16

### Automatic Measurement Function

Before Performing Automatic Measurement ..	16
Setting ImprintEQ .....	17
Turning ImprintEQ On/Off .....	19
Saving ImprintEQ Measurement Data on a	
PC .....	19
Adjusting and Saving the Target Curve .....	19
Adjusting the Time Correction Automatically	
(Auto TCR) .....	20
Adjusting for Road Noise (RoadEQ) .....	20
Turning RoadEQ On/Off .....	21

### Audio Setup/Adjustment

Setting MX Plus (Ai-NET Mode) .....	22
Setting MX Plus (Standalone Mode) .....	22
Setting the Graphic EQ .....	23
Setting the Parametric EQ .....	25
About the Crossover (X-Over) .....	26
Adjusting X-Over and Switching the	
Phases .....	26
Adjusting the Time Correction (TCR) .....	28

## Use the Multi Channel Function

Setting the 2-Channel Signal Playback Mode (2ch Playback Mode) .....	30
Setting the 2-Channel Signal Playback Mode (2ch Playback Mode) .....	30
Setting EUPHONY (EUPHONY) .....	30
Using Dolby Pro Logic II (Dolby Pro Logic II) .....	31
Multi Channel Function Adjustment Procedure .....	32
Multi Channel Setup .....	32
Adjusting the Speaker Volume Level (Output Level) .....	33
Adjusting the Acoustic Image (BI-PHANTOM) .....	33
Mixing the Low Range Audio for the Rear (Rear Mix) .....	33
Mixing the Low Range Audio of the Center with the Front L/R (Center Bass Split) ....	34
Setting the Linear PCM (PCM Mode) .....	34
Achieving Powerful High Volume Sound (Listening Mode) .....	34
Adjusting the DVD Level (DVD Level) .....	34

## From the Commander

### Basic Operation

Initial System Start-Up .....	35
Using with Ai-NET Connections .....	35
Turning Power On and Off .....	35
Audio Adjustment .....	35
Adjusting Subwoofer (SUBWOOFER) .....	35
Navigation Audio Volume Adjustment (NAVI LEVEL) .....	35
Adjusting the MX Plus Level (MX PLUS SETUP/LEVEL ADJUSTMENT) .....	36
Adjusting Balance (Between Left and Right) (BALANCE) .....	36
Adjusting Fader (Between Front and Rear) (FADER) .....	36
Setting Defeat (DEFEAT) .....	36
Adjusting Volume (VOLUME) .....	36
Switching the Sources .....	36
Storing the Preset Values (Preset Store) .....	36
Recalling a Stored Setting (Preset Call) .....	37
Setting the Speaker System (System Select) .....	37
Setting the Speakers (Speaker Setup) .....	38

Setting the Subwoofer Output (SW Channel) .....	38
Setting the AUX Input System (AUX Input Setup) .....	39
Setting the AUX Input (AUX IN) .....	39
Setting the Digital Input (Digital AUX) .....	40
Setting the AUX Volume Input Level (AUX IN Gain) .....	40
Adjusting the AUX Volume Level (AUX Level) .....	40
Naming the AUX Input (AUX Name) .....	41
Mixing Navi Audio Guidance (Navi Mix Setup) .....	41

### Automatic Measurement Function

Before Performing Automatic Measurement ..	42
Turning ImprintEQ On/Off .....	42
Adjusting the Time Correction Automatically (Auto TCR) .....	42
Adjusting for Road Noise (RoadEQ) .....	43
Turning RoadEQ On/Off .....	43

### Audio Setup/Adjustment

Setting the MX Plus (Ai-NET Mode) .....	44
Setting the MX Plus (Standalone Mode) .....	45
Setting the Equalizer Mode (EQ Mode) .....	46
Setting the Graphic EQ .....	46
Setting the Parametric EQ .....	47
About the Crossover (X-Over) .....	48
Adjusting X-Over and Switching the Phases .....	49
Adjusting the Time Correction (TCR) .....	50
Setting the Time Correction Adjustment Unit (TCR Parameter) .....	51

### Use the Multi Channel Function

Setting the 2-Channel Signal Playback Mode (Mode) .....	52
Setting EUPHONY (EUPHONY) .....	52
Using Dolby Pro Logic II (Dolby PLII) .....	53
Multi Channel Function Adjustment Procedure .....	54
Adjusting the Speaker Volume Level (Output Level) .....	54
Adjusting the Acoustic Image (BI-PHANTOM) .....	55



Mixing the Low Range Audio for the Rear (Rear Mix) .....	55
Mixing the Low Range Audio of the Center with the Front L/R (Center Bass Split) .....	56
Setting the Linear PCM (PCM Mode) .....	56
Achieving Powerful High Volume Sound (Listening Mode) .....	56
Adjusting the DVD Level (DVD Level) .....	57

## **Other Useful Features**

Lowering Volume Quickly (Mute) .....	57
Turning the Back Light Off (BLACK OUT function) .....	57
Setting the Color for the Commander Illumination Button (ILLUMINATION) ....	58
Adjusting the Brightness of the Display (Dimmer) .....	58
Adjusting the Brightness Level of the Display (Dimmer Level) .....	58
Switching the Display .....	59

## **Information**

System Configuration .....	60
Terminology .....	61
In Case of Difficulty .....	62
Specifications .....	63

# Operating Instructions

## WARNING



### WARNING

**This symbol means important instructions. Failure to heed them can result in serious injury or death.**

#### **DO NOT OPERATE ANY FUNCTION THAT TAKES YOUR ATTENTION AWAY FROM SAFELY DRIVING YOUR VEHICLE.**

Any function that requires your prolonged attention should only be performed after coming to a complete stop. Always stop the vehicle in a safe location before performing these functions. Failure to do so may result in an accident.

#### **KEEP THE VOLUME AT A LEVEL WHERE YOU CAN STILL HEAR OUTSIDE NOISES WHILE DRIVING.**

Excessive volume levels that obscure sounds such as emergency vehicle sirens or road warning signals (train crossings, etc.) can be dangerous and may result in an accident. LISTENING AT LOUD VOLUME LEVELS IN A CAR MAY ALSO CAUSE HEARING DAMAGE.

#### **DO NOT DISASSEMBLE OR ALTER.**

Doing so may result in an accident, fire or electric shock.

#### **KEEP SMALL OBJECTS SUCH AS BOLTS OR SCREWS OUT OF THE REACH OF CHILDREN.**

Swallowing them may result in serious injury. If swallowed, consult a physician immediately.

#### **USE THIS PRODUCT FOR MOBILE 12V APPLICATIONS.**

Use for other than its designed application may result in fire, electric shock or other injury.



### CAUTION

**This symbol means important instructions. Failure to heed them can result in injury or material property damage.**

#### **HALT USE IMMEDIATELY IF A PROBLEM APPEARS.**

Failure to do so may cause personal injury or damage to the product. Return it to your authorized Alpine dealer or the nearest Alpine Service Center for repairing.

## NOTICE

#### **Product Cleaning**

Use a soft dry cloth for periodic cleaning of the product. For more severe stains, please dampen the cloth with water only. Anything else has the chance of dissolving the paint or damaging the plastic.

#### **Temperature**

Be sure the temperature inside the vehicle is between +60°C (+140°F) and -10°C (+14°F) before turning your unit on.

#### **Maintenance**

If you have problems, do not attempt to repair the unit yourself. Return it to your Alpine dealer or the nearest Alpine Service Station for servicing.

#### **Installation Location**

Make sure the PXA-H800 will not be installed in a location subjected to:

- Direct sun and heat
- High humidity and water
- Excessive dust
- Excessive vibrations



### CAUTION

*Alpine accepts no responsibility for lost data, etc., even if data, etc., is lost while using this product.*

# Getting Started

## How to Read this Manual

The Commander (RUX-C800) for PXA-H800 is sold separately. Audio setup and adjustments are performed using the RUX-C800 or a PC running the Sound Manager software for PXA-H800.

Because the operation differs significantly between these two methods, each are described in separate sections for clarity. Each section is labeled as shown below.

### ■ From a PC

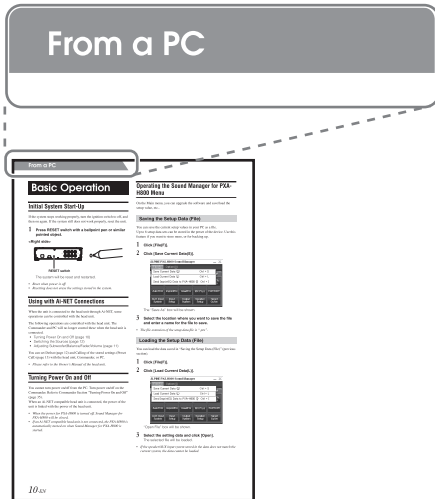

### ■ From the Commander

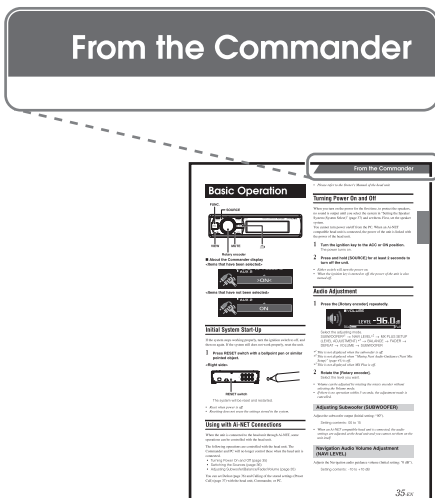

## Function list

Item	Page		
	PC	Commander	
Basic Operation	Turning Power On and Off	10	35
	Adjusting Balance	12	36
	Adjusting Fader	12	36
	Adjusting Subwoofer	12	35
	Adjusting Volume	12	36
	Setting Defeat	12	36
	Adjusting the MX Plus Level	—*1	36
	Switching the Sources	12	36
	Storing the Preset Values (Preset Store)	12	36
	Recalling a Stored Setting (Preset Call)	13	37
	Setting the Speaker System	13	37
	Setting the Speakers	14	38
	Setting the Subwoofers	14	38
	Setting the AUX Input System	14	39
	Setting the AUX input	15	39
	Setting the Digital Input	15	40
	Setting the AUX Volume Input Level	15	40
	Adjusting the AUX Volume Level	15	40
	Naming the AUX Input	16	41
Mixing Navi Audio Guidance	16	41	
Adjusting the Navigation Guidance Volume	16	35	
Automatic Measurement Function	Setting ImprintEQ	17	—
	Turning ImprintEQ On/Off	19	42
	Auto TCR	20	42
Audio Setup/ Adjustment	RoadEQ	20	43
	Setting MX Plus (Ai-NET Mode)	22	44
	Setting MX Plus (Standalone Mode)	22	45
	Setting the Equalizer Mode	23, 25*2	46
	Setting the Graphic EQ	23	46
	Setting the Parametric EQ	25	47
	Adjusting X-Over	26	49
Use the Multi Channel Function	Adjusting the Time Correction (TCR)	28	50
	Setting the TCR Parameter	29*3	51
	Setting the 2-Channel Signal Playback Mode	30	52
	Setting EUPHONY	30	52
	Customizing EUPHONY	31	—
	Using Dolby Pro Logic II	31	53
	Adjusting the Speaker Volume Level	33	54
	Adjusting BI-PHANTOM	33	55
	Setting Rear Mix	33	55
	Setting Center Bass Split	34	56
Setting the Linear PCM	34	56	
Setting the Listening Mode	34	56	
Adjusting the DVD Level	34	57	
Other Useful Features	Mute	—	57
	BLACK OUT Function	—	57
	Setting the Color for the Commander Illumination Button	—	58
	Adjusting the Dimmer	—	58
	Adjusting the Dimmer Level	—	58
Switching the Display	—	59	

\*1 The method to adjust MX Plus Level is described in “Setting MX Plus (Ai-NET Mode)”/“Setting MX Plus (Standalone Mode)”.

\*2 “Setting the Equalizer Mode” is included in the “Setting the Graphic EQ”/“Setting the Parametric EQ” operation.

\*3 “Setting the TCR Parameter” is included in the “Adjusting the Time Correction (TCR)” operation.

# Location of Controls

## PXA-H800

<Top surface>

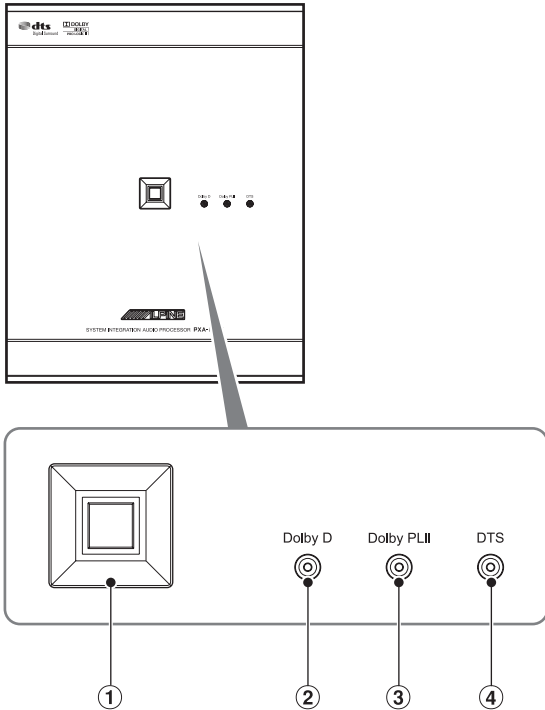

- ① **POWER indicator**  
Lights when Power is on.
- ② **Dolby Digital indicator**  
Lights when Dolby Digital decoding is enabled.
- ③ **Dolby Pro Logic II indicator**  
Lights when Dolby Pro Logic II is enabled.
- ④ **DTS indicator**  
Lights when DTS decoding is enabled

# Sound Manager for PXA-H800

Consists of two screens: the main screen and the sub screen. The sub screen varies depending on the function.

<Main screen sample>

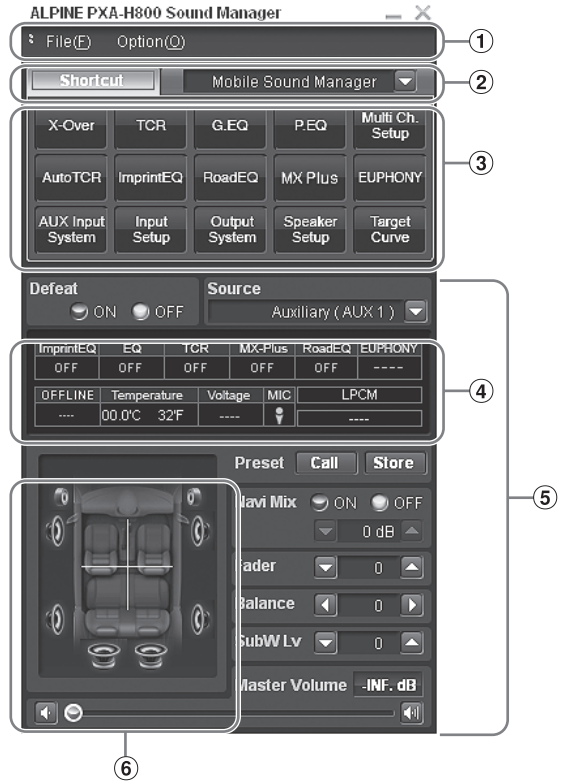

- ① **Menu**
- ② **Function switching tab**
- ③ **Shortcut switch to each function**
- ④ **Status indication**

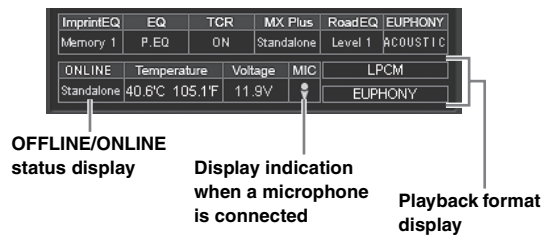

- ⑤ **Basic setting switching switch**
- ⑥ **Speaker system and Fader/Balance status indication**

## <Sub screen sample>

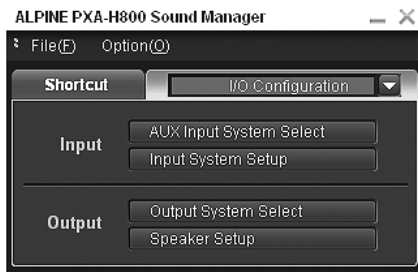
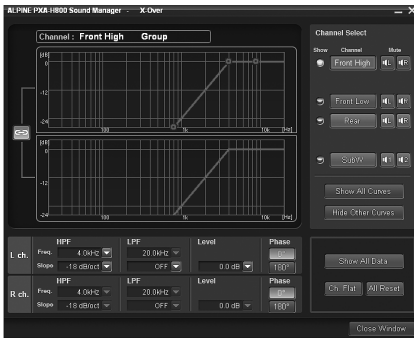

## RUX-C800 Commander (sold separately)

### About Operation on a PC

- Select and click the setup item or value.
- You can also use the [Tab], [←], [→], [↑], and [↓] keys on your PC to select the setup value or mode.
- For File(F) and Option(O) operation, refer to "Operating the Sound Manager for PXA-H800 Menu" (page 10).
- Common PC operation
  - [CANCEL]: Cancels the operation and takes you back to the previous screen.
  - [Close Window]: Closes the current window.

### Operating the Function Switching Tab

Operate the Function switching tab in the Main screen as follows:

#### 1 Click Function switching tab.

A pull-down menu will be displayed.

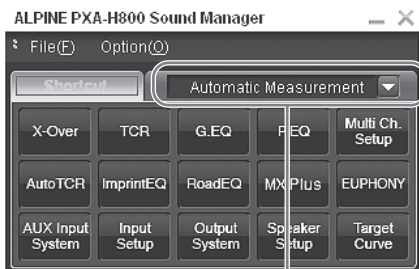

Click

#### 2 From the pull-down menu, select the tab to be switched to, and click it.

The screen will be switched to the selected tab.

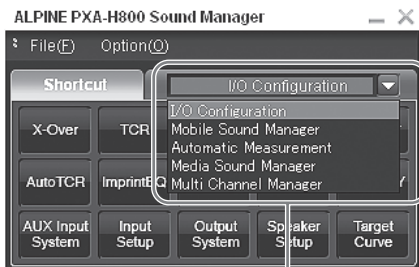

Click

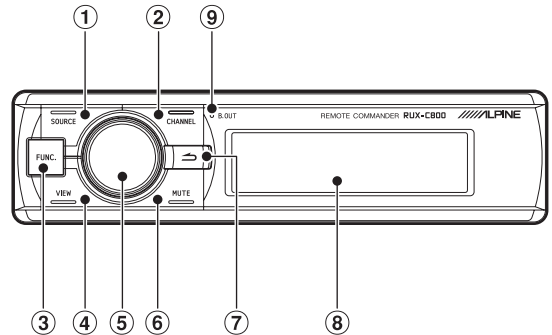

- SOURCE button**  
Switches the sources.
- CHANNEL button**  
Switches the adjustment channels. When pressed and held, the channel mode ("L or R" - "L+R") switching screen is displayed.
- FUNC. button**  
Displays the setup screen. When pressed and held, switches the ImprintEQ mode.
- VIEW button**  
Switches the display. When pressed and held, the Preset Call screen is displayed.
- Rotary encoder**  
Normal screen:  
Adjust the volume by turning to the left or right. When pressed and held, turns off the back light of the illuminated switch and the display. (BLACK OUT function)  
Setup/Adjustment screen:  
Select a item by turning to the left or right. When pressed, the item is set. When pressed and held, the Defeat setup screen is displayed.
- MUTE button**  
Lowers the volume by 20 dB instantly. In the adjustment screen, mutes the channel being adjusted.
- (Return) button**  
Returns to the previous item/screen. When pressed and held, the screen returns to the normal screen.
- Display**
- BLACK OUT indicator**  
Illuminates during BLACK OUT.

# Features

## About Operating

Install the included Sound Manager software for PXA-H800 on a PC. This provides the user with access to the all functions/features of this device.

Use the RUX-C800 (sold separately) to have access to many of the PXA-H800 functions without the need for a PC.

An Ai-NET compatible head unit provides limited functionality through its controls.

- The RUX-C800 Commander provides access to most of the PXA-H800 functions.
- To use all Automatic Measurement and Audio Setting/ Adjustment functions, a PC connection is required.

### ■ Availability of operations

	Power ON/OFF	Automatic adjustment	Audio setup/ adjustment
Commander (sold separately) (RUX-C800)	○	△ (Only some functions available*1)	○
PC (Sound Manager for PXA-H800)	×	○	○
Ai-NET compatible head unit	○	×	△ (Only some functions available*2)

\*1 You cannot run ImprintEQ measurement.

\*2 For details about the functions available on the Ai-NET compatible head unit, refer to "Using with Ai-NET Connections" (page 10)/ (page 35).

- When Sound Manager for PXA-H800 is running, the RUX-C800 Commander becomes disabled.
- For details about the functions available on the Commander and on the PC, refer to "Function list" (page 5).

## About the Audio Setting

The inherent sound quality inside a vehicle varies widely. Numerous factors, including media used, vehicle type, speakers, etc., contribute to this inconsistency. This processor is able to compensate for many of these factors to optimize the sound automatically.

### ImprintEQ

ImprintEQ is a system to obtain the optimum acoustic effect at each seat based on the automatically measured acoustic data of the cabin.

### RoadEQ

Road EQ (REAL-TIME OPTIMIZED ADAPTIVE DRIVING EQ) is a function to automatically adjust the EQ properties in accordance with the road noise while driving.

### TCR (Time Correction)/Auto TCR (Automatic Time Correction)

In a vehicle, it is not possible to change the listening positions of the user. Using Time Correction, an optimized listening position is created no matter where the user is seated. This automated adjustment is able to focus the auditory image as well as expand the sound field making for a more natural sound.

"TCR" digitally delays the sound output from each speaker in order to align the timing of the sound reaching the listener.

### MX Plus

MX (Media Xpander) Plus enhances the vocal and instrumental sounds for each music source. MX Plus generates harmonics and compensates high frequency information. This helps improve music clarity even in a cabin with loud road noise.

### Graphic Equalizer

The Graphic EQ divides the audio band into 31 individual bands. Each band is individually controlled to balance the sound and enhance detail.

### Parametric Equalizer

The Parametric EQ has fewer bands but gives more control over where the band is located in the audio spectrum. The user can also control how much overlap with adjacent frequencies (Q). This provides you with a sound control feature of professional-level, which allows you to adjust an extremely narrow range in pin-point fashion without affecting the neighboring sound regions.

### X-Over

The X-Over allows this processor to output audio within a specific band. These specific bands are sent to drive speakers optimized to reproduce those bands. Use the integrated HPF (High Pass Filter) or LPF (Low Pass Filter) to create a specified output for each channel. The Slope and Level of each channel is also adjustable.

### 5.1 ch theater surround compatible

Get true, 5.1 "Theater Surround." Create a concert hall experience in your vehicle.

### EUPHONY

EUPHONY is an innovative sound field reproduction method which DiMAGIC has created with the latest acoustic technology based on the core concept of "enjoying beautiful sound." Taking maximum advantage of minute differences of sound between the right and left stereo signals, reverberation, and acoustics, with adaptive filters, the realistic sensation of sound field is created. The system features sound quality that is pleasant even after long listening, which is the optimum sound for long distance driving.

## Before You First Use the Unit

When you first use the unit, set the following:

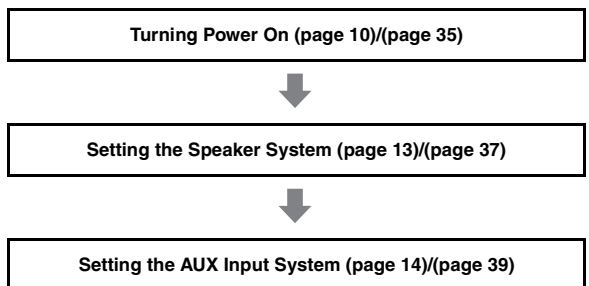

## Installing Sound Manager for PXA-H800

When you install Sound Manager for PXA-H800 on a PC, you can set/adjust the audio settings on the PC.

### Caution before installing:

- This Program runs under Microsoft® Windows® XP, Vista, 7 only.

### Recommended specifications

OS: Windows XP, Windows Vista, Windows 7

CPU: 1.6 GHz or higher

Memory: 1 GB or higher

HDD: 512 MB or more available space

Display: 1024×576 or higher

- Install the Sound Manager software for PXA-H800 before connecting the PXA-H800 to your personal computer.
- Before installing, all active programs must be stopped.

- 1 Insert the supplied CD-ROM (Sound Manager for PXA-H800) into the CD-ROM drive. Run the setup.exe file. Follow the installation instructions on the screen.**
- 2 Connect a PC to Computer connection terminal of PXA-H800 with the included USB cable.**

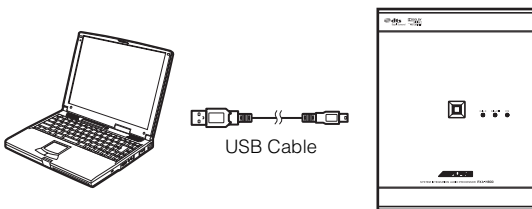

- *Install the PXA-H800 in your vehicle before you connect a PC to it (refer to the Installation manual). Turn the ignition key to the ACC or ON position.*

- 3 Start Sound Manager for PXA-H800.**

## CAUTION

- Strictly observe the Warnings and Cautions written by the manufactures of your PC and peripheral equipment.
- We do not accept responsibility for data lost due to the incorrect operation of the Sound Manager for PXA-H800. We recommend you to back-up your important data regularly.

### About the OFFLINE mode

Sound Manager for PXA-H800 checks the connection with the PXA-H800 at startup. When the connection is detected, it starts in the online mode. If the connection is not detected, a message will be displayed.

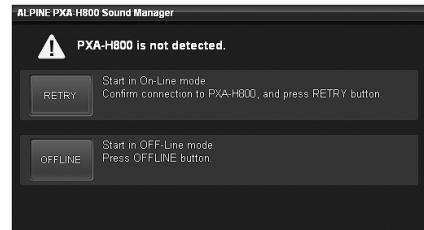

To start the PXA-H800 in the offline mode, click [OFFLINE]. To set in the offline mode, perform the following steps to reflect the settings on the PXA-H800.

- 1 After making adjustments and settings, save the data on the PC, referring to “Saving the Setup Data (File)” (page 10).**
- 2 Close Sound Manager for PXA-H800.**
- 3 Connect to the PXA-H800 to your PC and start Sound Manager for PXA-H800 in the online mode.**
  - *Install the PXA-H800 in your vehicle before you connect a PC to it (refer to the Installation manual). Turn the ignition key to the ACC or ON position.*
- 4 Load the data saved on the PC referring to “Loading the Setup Data (File)” on page 10.**

The settings of Sound Manager for PXA-H800 are reflected on the PXA-H800.

# Basic Operation

## Initial System Start-Up

If the system stops working properly, turn the ignition switch to off, and then on again. If the system still does not work properly, reset the unit.

- 1 Press **RESET** switch with a ballpoint pen or similar pointed object.

<Right side>

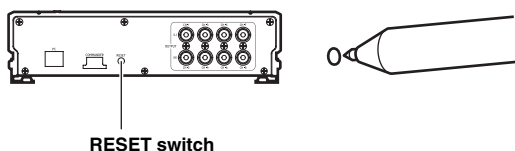

The system will be reset and restarted.

- Reset when power is off.
- Resetting does not erase the settings stored in the system.

## Using with Ai-NET Connections

When the unit is connected to the head unit through Ai-NET, some operations can be controlled with the head unit.

The following operations are controlled with the head unit. The Commander and PC will no longer control these when the head unit is connected.

- Turning Power On and Off (page 10)
- Switching the Sources (page 12)
- Adjusting Subwoofer/Balance/Fader/Volume (page 11, 12)

You can set Defeat (page 12) and Calling of the stored settings (Preset Call) (page 13) with the head unit, Commander, or PC.

- Please refer to the Owner's Manual of the head unit.

## Turning Power On and Off

You cannot turn power on/off from the PC. Turn power on/off on the Commander. Refer to Commander Section "Turning Power On and Off" (page 35).

When an Ai-NET compatible head unit is connected, the power of the unit is linked with the power of the head unit.

- When the power for PXA-H800 is turned off, Sound Manager for PXA-H800 will be closed.
- If an Ai-NET compatible head unit is not connected, the PXA-H800 is automatically turned on when Sound Manager for PXA-H800 is started.

## Operating the Sound Manager for PXA-H800 Menu

On the Main menu, you can upgrade the software and save/load the setup value, etc.

### Saving the Setup Data (File)

You can save the current setup values in your PC as a file.

Up to 6 setup data sets can be stored in the preset of the device. Use this feature if you want to store more, or for backing up.

- 1 Click **[File(F)]**.
- 2 Click **[Save Current Data(S)]**.

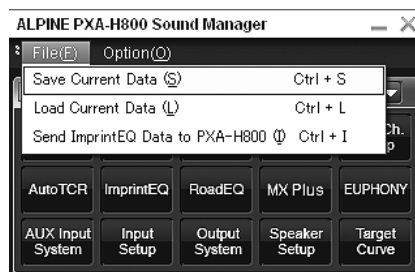

The "Save As" box will be shown.

- 3 Select the location where you want to save the file and enter a name for the file to save.

- The file extension of the setup data file is ".pre".

### Loading the Setup Data (File)

You can load the data saved in "Saving the Setup Data (File)" (previous section).

- 1 Click **[File(F)]**.
- 2 Click **[Load Current Data(L)]**.

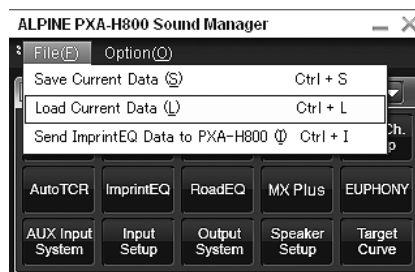

"Open File" box will be shown.

- 3 Select the setting data and click **[Open]**.

The selected file will be loaded.

- If the speaker/AUX input system stored in the data does not match the current system, the data cannot be loaded.



## Loading the ImprintEQ Measurement Data (File)

Load the ImprintEQ measurement data stored in the PC into PXA-H800.

- 1 Click [File(F)].
- 2 Click [Send ImprintEQ Data to PXA-H800(I)].

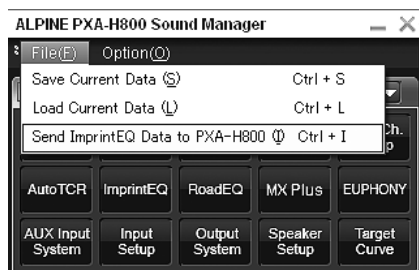

"Open File" box will be shown.

- The file extension of the ImprintEQ measurement data file is ".ieq".

- 3 Select the ImprintEQ measurement data stored in the PC and click [Open].  
The selected file will be loaded. The Memory Selection screen will be displayed.
- 4 Select [ImprintEQ Memory 1] or [ImprintEQ Memory 2], and click [OK].  
The file is written in the PXA-H800 memory.

- Select [File] to save ImprintEQ measurement data on a PC.
- For the ImprintEQ, refer to "Setting ImprintEQ" (page 17).

## Downloading the Software (Option)

You can download the software to a newer version.

### Warning for downloading

- When you download a file, all setup data in the PXA-H800 will be deleted. Please note that once deleted it cannot be recovered. Before downloading, it is recommended to save the setting data. Refer to "Saving the Setup Data (File)" (page 10).
- Downloading takes approximately 20 minutes. Do not turn off the PXA-H800 or disconnect the USB cable until the download is completed.

- 1 From the Alpine Web site, download the file for upgrading the software and store it in your PC.

- For details on the procedure, refer to the Alpine Web site.

- 2 Click [Option(O)].
- 3 Click [Software Download(D)].

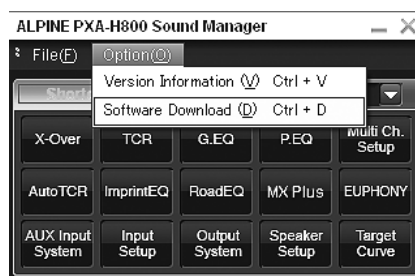

- 4 Click [OK] when a confirmation message appears.  
"Open File" box will be shown.

- 5 Select the file you have stored in Step 1 and click [Open].  
The file will be downloaded and the version upgrade process will be started. When the download is completed, a confirmation message will be displayed.

- 6 Click [OK].  
Following the instructions on the screen, restart the PXA-H800 unit and Sound Manager for PXA-H800.

## Viewing the Version Information (Option)

You can view the version information for PXA-H800 and Sound Manager for PXA-H800.

- 1 Click [Option(O)].
- 2 Click [Version Information (V)].

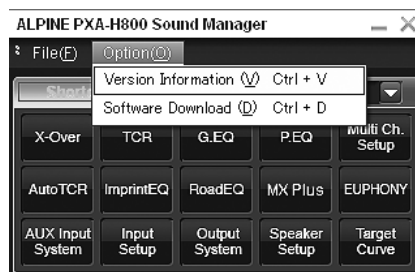

The version information will be shown.

## Audio Adjustment

When an Ai-NET compatible head unit is connected, the audio settings are adjusted at the head unit and you cannot adjust the unit from the PC.

- 1 Make adjustments using [◀], [▶], [▲], [▼], [↩], and [⏪] for "Fader," "Balance," "SubW Lv," or "Master Volume" in the main menu.



## Adjusting Fader (Between Front and Rear)

Adjust the Front and Rear speaker volume (Initial setting: "0").

Setting contents: F (Front) 15 to C (Center) 0 to R (Rear) 15

## Adjusting Balance (Between Left and Right)

Adjust the Right and Left speaker volume (Initial setting: "0").

Setting contents: L (Left) 15 to C (Center) 0 to R (Right) 15

## Adjusting Subwoofer (SubW Lv)

Adjust the subwoofer output (Initial setting: "0").

Setting contents: 0 to 15

- This has no effect when the subwoofer is off.

## Adjusting Volume

Adjust the volume. (Initial setting: "-INF. dB")

### 1 Drag [🔊] or click [⏮] or [⏭] to make adjustments.

Pressing and holding [⏮] or [⏭] will continuously decrease/increase volume.

Setting contents: -INF. to 0 dB

## Setting Defeat

When Defeat is set to [ON], the settings for ImprintEQ, Graphic EQ, Parametric EQ, MX Plus, RoadEQ, and Time Collection are restored to the initial values (Initial setting: "OFF").

### 1 Click [ON] or [OFF] for "Defeat" in the main menu.



## Switching the Sources

The unit accepts up to five analog signal input lines and 2 digital signal input lines. For the connection, refer to the installation manual.

When an Ai-NET compatible head unit is connected, the source should be switched at the head unit.

### 1 Click [▼] for "Source" in the main menu and select and click the source you want from the pull-down menu.

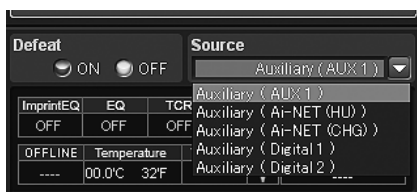

The source is switched to the selected one.

Setting contents: Auxiliary\*(AUX1)/Auxiliary(AUX2)/  
Auxiliary(AUX3)/Auxiliary(Ai-NET(HU))/  
Auxiliary(Ai-NET(CHG))/Auxiliary(Digital1)/  
Auxiliary(Digital2)

- \* Names selected in "Naming the AUX Input (AUX Name)" (page 16) are displayed as the source names. The initial setting is "Auxiliary."
- The number of analog signal inputs varies depending on the setting in "Setting the AUX Input System (AUX Input System Select)" (page 14).
- Only sources set as ON in "Setting the AUX Input (AUX IN)" (page 15) and "Setting the Digital Input (Digital AUX)" (page 15) are displayed.

## Storing the Preset Values (Preset Store)

You can store up to 6 sets of the adjustment/setting values. All of the following adjustment/setting values are stored in a single preset memory.

Adjustment/Setup items	Pages
Setting the Speaker System (Output System Select)	13
Setting the Speakers (Speaker Setup)/Setting the Subwoofers	14
Setting the AUX Input System (AUX Input System Select)	14
Setting the AUX Input (AUX IN)	15
Setting the Digital Input (Digital AUX)	15
Setting the AUX Volume Input Level (AUX IN Gain)	15
Adjusting the AUX Volume Level (AUX Level)	15
Naming the AUX Input (AUX Name)	16
Turning ImprintEQ On/Off	19
Turning RoadEQ On/Off	21
Setting MX Plus (Ai-NET Mode)	22
Setting MX Plus (Standalone Mode)	22
Setting the Graphic EQ	23
Setting the Parametric EQ	25
Adjusting X-Over and Switching the Phases	26
Adjusting the Time Correction (TCR)	28
Setting the 2-Channel Signal Playback Mode (2ch Playback Mode)	30
Setting EUPHONY (EUPHONY)	30
Using Dolby Pro Logic II (Dolby Pro Logic II)	31
Adjusting the Center Width (Center Width)	32
Adjusting the Speaker Volume Level (Output Level)	33
Adjusting the Acoustic Image (BI-PHANTOM)	33
Mixing the Low Range Audio for the Rear (Rear Mix)	33
Mixing the Low Range Audio of the Center with the Front L/R (Center Base Split)	34
Setting the Linear PCM (PCM Mode)	34
Achieving Powerful High Volume Sound (Listening Mode)	34
Adjusting the DVD Level (DVD Level)	34

### 1 Adjust the value you want to store and set it.

### 2 Click [Store] for "Preset" in the main menu.



- 3 Click one from [Preset 1] to [Preset 6], and then click [OK].

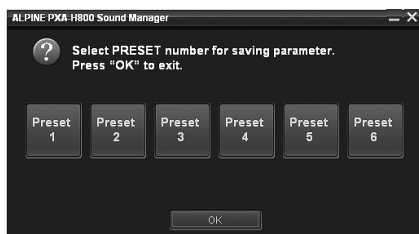

The data is stored in the preset number.

- The function is operable when Defeat is set to OFF.
- Measurement values will not be lost in the event the system is reset or battery power is disconnected.

## Recalling a Stored Setting (Preset Call)

The preset memory stores various setting/adjustment information. Thus, it takes some time to call data from the preset memory.

- 1 Click [Call] for “Preset” in the main menu.



- 2 Click one from [Preset 1] to [Preset 6], and then click [OK].

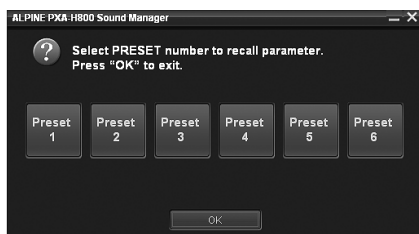

The values of the selected preset number are retrieved.

- The function is operable when Defeat is set to OFF.
- If the speaker system in the preset and the current speaker system do not match, the preset cannot be retrieved.
- If the AUX input system in the preset and the current AUX input system do not match, the items concerning the AUX input system are unavailable for retrieval.

## Setting the Speaker System (Output System Select)

Unless you select the output system, you cannot set any features. Be sure to set the system first. If the selected system and the actual speaker connections do not match, the speakers may be damaged. Make sure to check the specifications of the speakers before selecting the system.

### Only for the initial startup:

- 1 Click [OK] when a message appears.

The Output System Select screen is displayed. Go to Step 2.

- 1 Click [Output System] for [Shortcut] tab in the main menu.

The Output System Select screen is displayed.

- When you click [I/O Configuration] on the Function switching tab and then [Output System Select], the Output System Select screen will also be displayed. Refer to “Operating the Function Switching Tab” (page 7).

- 2 Select and click the speaker system, and then click [NEXT].

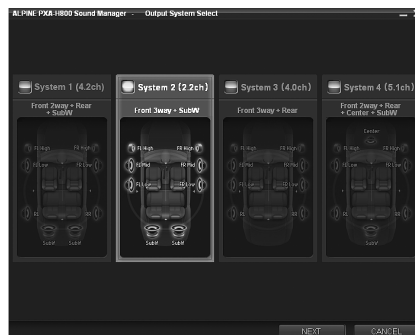

System 1 (4.2ch): Front 2way+Rear+SubW

System 2 (2.2ch): Front 3way+SubW

System 3 (4.0ch): Front 3way+Rear

System 4 (5.1ch): Front 2way+Rear+Center+SubW

- Refer to Table 1 (Output System) in “System Configuration” (page 60).

Click [OK] when a confirmation message appears.

The Speaker Setup screen will be automatically displayed.

- If no changes are made to current system settings, the operation will close without displaying the confirmation screen.

- 3 Click [Full Range], [ON] or [OFF], etc., to set the speakers.

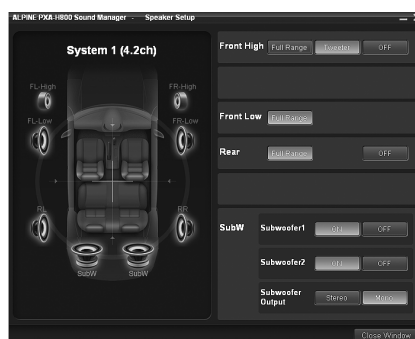

Front High\*<sup>1</sup>: Full Range/Tweeter/OFF

Front Mid: Full Range

Front Low: Full Range/OFF

Rear: Full Range/OFF

Center: Full Range/OFF

Subwoofer (1, 2): ON/OFF

Subwoofer Output: Stereo/Mono \*<sup>2</sup>

\*<sup>1</sup> When you modify the “Front High” speaker setting to [Full Range], a message to confirm the change will be displayed. To set up at “Full Range,” select [YES] and click [OK]. Make sure the speaker being used for this output is able to handle a full range source. Many tweeters can be damaged when driven by a full range signal.

\*<sup>2</sup> Only when two subwoofers are connected, is this item able to be set.  
Stereo: Subwoofer stereo (L/R) output  
Mono: Subwoofer monaural output

- Speakers that cannot be turned off do not show "OFF." Refer to Table 1 (Output System) in "System Configuration" (page 60).
- If the speaker system is changed, all setup values except those for AUX input will be restored to the initial setup values.
- You can also set the speakers from "Setting the Speakers (Speaker Setup)/Setting the Subwoofers" (page 14).
- When you connect just one subwoofer, turn off "Subwoofer2."
- After the setting, storing the setting contents on the unit is recommended. For details, refer to "Storing the Preset Values (Preset Store)" (page 12).

#### 4-1 First time start-up:

Click [NEXT]. The AUX Input System Select screen will display automatically. Continue to set, referring to "Setting the AUX Input System (AUX Input System Select)" (page 14).

#### 4-2 Subsequent start-up:

Click [Close Window]. The confirmation screen will be displayed. Click [OK]. Sound Manager for PXA-H800 will be closed. Turn the ignition key to off and then on again. The settings become effective.

## Setting the Speakers (Speaker Setup)/ Setting the Subwoofers

Turn on the connected speakers.

If 2 subwoofers are connected, you can choose either stereo or monaural for the subwoofer output. Set depending on the subwoofers to be connected (Initial setting: "Mono").

### 1 Click [Speaker Setup] for [Shortcut] tab in the main menu.

The Speaker Setup screen is displayed.

- If you click [I/O Configuration] on the Function switching tab, and then [Speaker Setup], the Speaker Setup screen will also be displayed. Refer to "Operating the Function Switching Tab" (page 7).

### 2 Click [Full Range], [ON] or [OFF], etc., to set the speakers.



- Front High\*1: Full Range/Tweeter/OFF
- Front Mid: Full Range
- Front Low: Full Range/OFF
- Rear: Full Range/OFF
- Center: Full Range/OFF
- Subwoofer (1, 2): ON/OFF
- Subwoofer Output: Stereo/Mono\*2

- \*1 When you modify the "Front High" speaker setting to [Full Range], a message to confirm the change will be displayed. To set at "Full Range," select [YES] and click [OK]. Make sure the speaker being used for this output is able to handle a full range source. Many tweeters can be damaged when driven by a full range signal.
- \*2 Only when two subwoofers are connected, is this item able to be set.  
Stereo: Subwoofer stereo (L/R) output  
Mono: Subwoofer monaural output

- Speakers that cannot be turned off do not show "OFF." Refer to Table 1 (Output System) in "System Configuration" (page 60).
- When you connect just one subwoofer, turn off "Subwoofer2."
- The speaker settings here will depend on which system was selected in "Setting the Speaker System (Output System Select)" (page 13).

### 3 When setting is complete, click [Close Window].

- When the speaker setting is changed while ImprintEQ/RoadEQ is on, ImprintEQ/RoadEQ will be turned off after a confirmation message is displayed.
- After the setting, it is recommended to store the setting contents on the unit. For details, refer to "Storing the Preset Values (Preset Store)" (page 12).

## Setting the AUX Input System (AUX Input System Select)

This step sets the six channel RCA input of the unit. The input volume levels can also be set.

At initial startup, the AUX Input System Select screen is displayed automatically after the speakers are set. Step 1 is unnecessary.

### 1 Click [AUX Input System] for [Shortcut] tab in the main menu.

The AUX Input System Select screen is displayed.

- When you click [I/O Configuration] on the Function switching tab, and then [AUX Input System Select], the AUX Input System Select screen will also be displayed. Refer to "Operating the Function Switching Tab" (page 7).

### 2 Select and click the AUX Input System, and then click [NEXT].



- Analog 5.1ch. Input:  
AUX1 (Front Left, Front Right, Rear Left, Rear Right, Center, Subwoofer)
- Analog 4ch. +2ch. Input:  
AUX1 (Front Left, Front Right, Rear Left, Rear Right)/AUX2 (Left, Right)
- Analog 2ch. x3 Input:  
AUX1 (Left, Right)/AUX2 (Left, Right)/AUX3 (Left, Right)

- Refer to Table 2 (Input System) in “System Configuration” (page 60).

Click [OK] when a confirmation message appears.  
The AUX Gain Setup screen is displayed.

- 3** Click either [High] or [Low] for each AUX to set and click [OK].

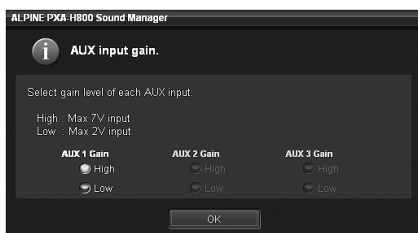

High: When the volume level of the external input is high.

Low: When the volume level of the external input is low.

- 4** Click [OK] when a confirmation message appears.  
Exit Sound Manager for PXA-H800. Turn the ignition key to off, and then on again. The settings become effective.

- Gain can also be set in “Setting the AUX Volume Input level (AUX IN Gain)” (page 15).
- When the AUX input system is changed, all the setup values for AUX input will be restored to the initial setup values.
- After the setting, it is recommended to store the setting contents on the unit. For details, refer to “Storing the Preset Values (Preset Store)” (page 12).

## Setting and Adjusting the AUX Input/Digital Input (Analog AUX Input/Digital AUX Input)

This step sets and adjusts the Analog AUX and Digital AUX.

- When an Ai-NET compatible head unit is connected, external input of the PXA-H800 becomes unavailable, and this setting will be disabled.

- 1** Click [Input Setup] for [Shortcut] tab in the main menu.

The Input System Setup screen is displayed.

- If you click [I/O Configuration] on the Function switching tab, and then [Input System Setup], the Input System Setup screen will also be displayed. Refer to “Operating the Function Switching Tab” (page 7).

- 2** For each AUX, click [ON]/[OFF], [High]/[Low], or [▲ ]/[▼ ] to set and adjust each item.

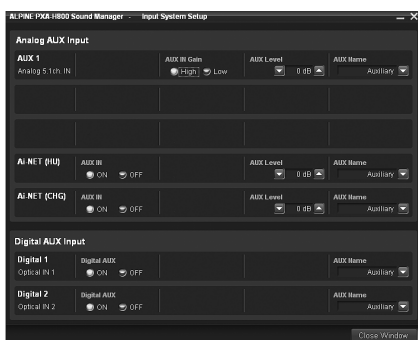

### Setting the Analog AUX Input

Setting item: AUX 1~3\*<sup>1</sup>/Ai-NET(HU) \*<sup>2</sup>/  
Ai-NET(CHG) \*<sup>2</sup>

Setting contents: AUX IN/AUX IN Gain/AUX Level/AUX Name

\*<sup>1</sup> The number of AUX channels to be set varies depending on the system set in “Setting the AUX Input System (AUX Input System Select)” (page 14).

\*<sup>2</sup> When you connect Ai-NET/RCA Interface cable (KCA-121B) to the terminals of the device Head Unit input terminal (Ai-NET input) / Changer input terminal (Ai-NET input), you can use it as AUX.

### Setting the Digital AUX Input

Setting item: Digital1/Digital2

Setting contents: Digital AUX/AUX Name

- 3** When setting is complete, click [Close Window].

- After the setting, it is recommended to store the setting contents on the unit. For details, refer to “Storing the Preset Values (Preset Store)” (page 12).

### Setting the AUX Input (AUX IN)

A TV or VCR with RCA audio output can be connected to the unit. Select OFF the external input not is connected (Initial setting: “ON”).

Setting item: AUX IN  
Setting contents: ON/OFF

- AUX1 cannot be set.

### Setting the Digital Input (Digital AUX)

Select OFF if no optical digital product is connected (Initial setting: “ON”).

Setting item: Digital AUX  
Setting contents: ON/OFF

### Setting the AUX Volume Input level (AUX IN Gain)

If the external input audio becomes distorted, select High (Initial setting: “High”).

Setting item: AUX IN Gain  
Setting contents: High/Low

High: When the volume level of the external input is high.  
Low: When the volume level of the external input is low.

- This item becomes possible to set only when AUX IN setting is on.
- You can only adjust the Analog AUX with this setting.

### Adjusting the AUX Volume level (AUX Level)

You can adjust the volume level of the external RCA input. Adjust this when the volume is higher or lower compared to that of the optical digital source (Initial setting: “0 dB”).

Setting item: AUX Level  
Setting contents: -10 to +10 dB

- This item becomes possible to set only when AUX IN setting is on.
- You can only adjust the Analog AUX with this setting.

## Naming the AUX Input (AUX Name)

When you connect an external input source, you can name it with a suitable name (Initial setting: "Auxiliary").

- 1 Click [▼] for each AUX and select and click the external input product name from the pull-down menu.

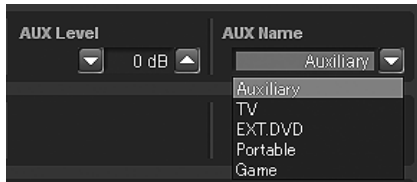

Setting item: AUX Name

Setting contents: Auxiliary/TV/EXT.DVD/Portable/Game

- This item becomes possible to set only when AUX IN setting is on.

## Setting/Adjusting the Navigation Guidance Volume (Navi Mix)

If a navigation system is connected, its voice guidance will be mixed with the system and output from the front speakers (Initial setting: "OFF"). You can adjust the navigation guidance volume (Initial setting: "0 dB").

- 1 Click [ON] or [OFF] for "Navi Mix" in the main menu.

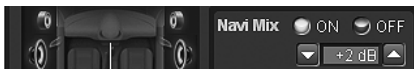

If you click [ON], select the setting value.

- 2 Click [▼] or [▲] to adjust the volume.

Setting contents: -10 to +10 dB

- For details on the connection of a navigation system, refer to the installation manual.

# Automatic Measurement Function

## Before Performing Automatic Measurement

This unit is equipped with ImprintEQ, RoadEQ, and AutoTCR automatic measurement functions.

### WARNING

- Do not perform automatic measurement while the vehicle is running. Automatic measurement requires microphones to be installed in the cabin to measure acoustic characteristics, and the speakers may output loud noise for measurement. This may interfere with safe driving and lead to an accident.

### Be sure to read before performing automatic measurement.

- The automatic measurement should be performed in a quiet place with the engine, air-conditioner, and heater turned off. If a mobile phone or car phone is installed in the vehicle, move them outside of the cabin, or turn the power off. Sound other than the measuring sound (ambient noise around the vehicle, engine noise, and ringtones) may interfere with measurement, resulting in inaccurate measurement of the acoustic characteristics of the cabin.
- Be aware that the battery may be drained if you use the unit for an extended period of time without running the engine.
- The microphone supplied with this product is specifically designed for this type of measurement. Use of any other microphone will give poor or no results. Use of microphones other than the one supplied is not recommended.
- If the system is equipped with a power amplifier with input level control or a powered subwoofer, the measurement may not be possible if the input level is set low. However, to perform correct measurement, the input level should not be set too high.
- For a power amplifier with low-pass filter, turn off the low-pass filter of the power amplifier to make measurement. The low-pass filter in the powered subwoofer or the power amplifier for a subwoofer should be set at the highest cutoff frequency.

### Measurement sequence for the automatic measurement functions

Perform the automatic measurement in the following sequence.

#### When ImprintEQ is used:

First, ImprintEQ, then RoadEQ.

#### When ImprintEQ is not used:

First, Auto TCR, then RoadEQ.

- When ImprintEQ is used, AutoTCR is not required.
- When ImprintEQ and AutoTCR are performed after RoadEQ, re-perform RoadEQ.



## Setting ImprintEQ

ImprintEQ is a system to obtain the optimum acoustic effect from each seat position, based on the automatically measured acoustic data of the cabin.

To use ImprintEQ, you should perform acoustic measurement of the cabin beforehand.

### ImprintEQ measurement flow

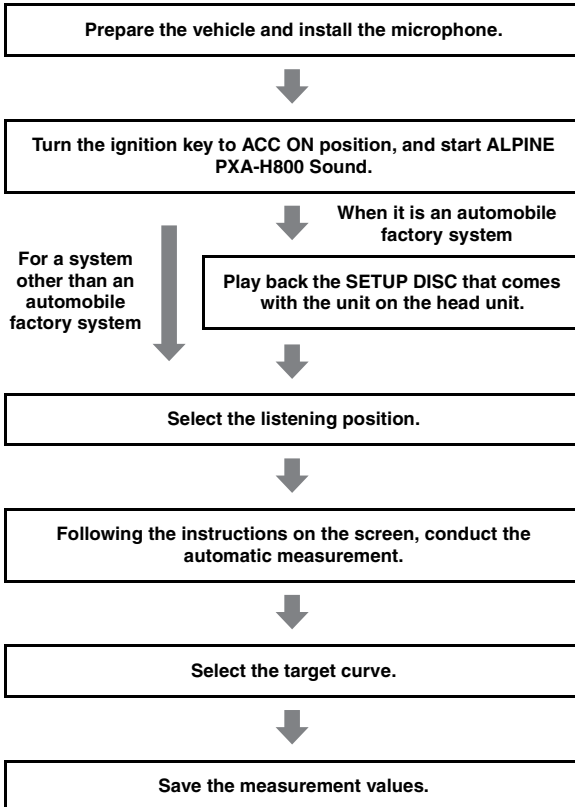

### 1 Preparing for measurement.

- Park the vehicle in a quiet location.
- Close doors, windows, sunroof, etc.
- Turn the air-conditioner and heater OFF.
- Turn off the engine of the vehicle.

### 2 Preparing the microphone.

Place the microphone at ear level (a camera tripod is useful for this purpose).

- The direction of the microphone does not affect the measurement.

### 3 Turn the ignition switch of the vehicle to ACC (On).

- If an air-conditioner or heater is turned on, turn it off. Measurement should not be performed if air-conditioner or heater noise is present.

### 4 Click [ImprintEQ] for [Shortcut] tab in the main menu.

The Automatic Measurement tab screen will be displayed.

- When you click [Automatic Measurement] in the Function switching tab, the Automatic Measurement tab screen will also be displayed. Refer to "Operating the Function Switching Tab" (page 7).

### 5 Click [Setup] for "ImprintEQ."

The ImprintEQ mode selection screen will be displayed.

### 6 Select either [Factory Audio] or [Other] and click.

Factory Audio: When an automobile factory system is connected to AUX1, choose this.

Other: Choose [Other] when a head unit other than an automobile factory system (commercially available unit including ALPINE products) is connected.

If you select [Factory Audio], go to Step 7.  
If you select [Other], go to Step 10.

### 7 Insert the SETUP DISC into the head unit. Click [START] within 10 seconds of Track01 starting.

### 8 Following the instructions on the screen, adjust the input level of the device connected to AUX1. When "OK" is displayed, click [OK].

### 9 Click [START] within 10 seconds of Track02 starting.

Measurement of the frequency characteristic will be started. When measurement is completed, a confirmation message will be displayed.

- If you want to stop measurement, click [CANCEL].

### 10 Click [OK] when a message appears.

The Area Selection screen is displayed.

### 11 Select the listening position. Select the area from [ALL], [FRONT], [FRONT LEFT], [FRONT RIGHT], and [REAR], and click [Next].

If [ALL] is selected, the system will measure the characteristics from all seat positions.

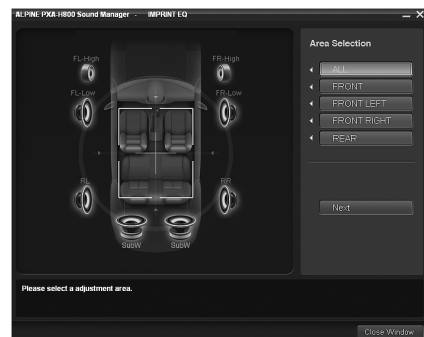

The measurement screen will be displayed.

## 12 Move the microphone to a spot specified in the screen and position it firmly.

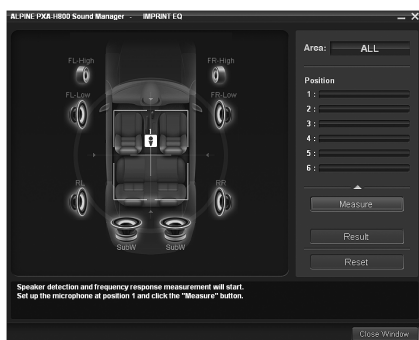

- The microphone should be placed at shoulder height.

## 13 Click [Measure]. When the measurement start screen appears, click [START].

Countdown will start.

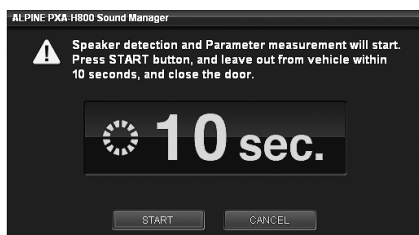

During the 10 second countdown, go outside the vehicle and close the door.

A test signal will be output from the speakers to measure the acoustic characteristics of the cabin. Do not open any doors until the finish message appears on the screen. If external noise interferes with the measurement, click the [Measure] again to re-measure.

- Measurement takes approximately 5 to 15 minutes.
- If you want to stop measurement, click [CANCEL].

## 14 Click [OK] when a completed message appears.

## 15 When measurement for Position 1 is completed, move the microphone to the next measuring position and secure it following the guidance on the screen. When the microphone is properly located, repeat Step 13 following the guidance on the screen.

- You can perform measurement from up to 6 listening positions.
- We recommend that you should take measurements from at least 2 listening positions.
- To close measurement, go to Step 16.
- For more accurate measurement, you can make measurements from 6 listening positions. However, it takes approximately 70 minutes to complete the entire procedure. Therefore, be sure to charge the vehicle battery while taking measurements.
- If no microphone is connected, a confirmation message will be displayed and measurement will not be carried out. Click [OK] to cancel the indication.
- If you want to re-measure from the same position, click [Reset].

## 16 When measurement is complete, click [Result].

The result screen will be displayed.

The adjustment result when the Target Curve is "REFERENCE" will be displayed.

## If you want to select another target curve, go to Step 17. If you want to save the adjustment result, go to Step 19.

## 17 Click [Target Curve Select].

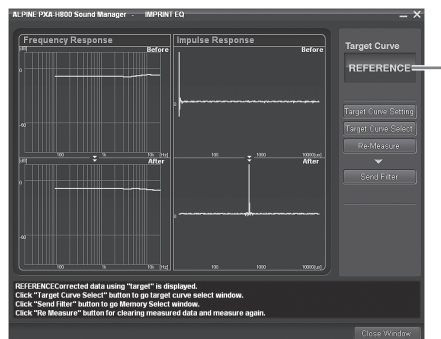

The name of the curve currently selected.

The Target Curve Selection screen will be displayed.

## 18 Select and click the target curve you want. Then, click [OK].

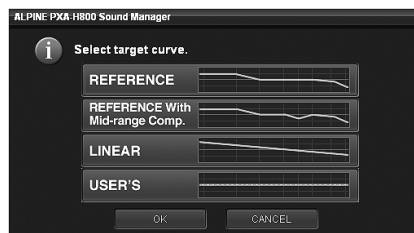

The adjustment result for the selected Target Curve will be displayed.

### REFERENCE:

Enjoy the rhythm and balance of music to the best acoustic effect, suitable for the vehicle interior.

### Reference With Mid-range Comp.:

Select this if the tweeter and midrange speakers are installed in the dashboard, and mid or high range harshness is apparent.

### LINEAR:

A linear (flat) acoustic effect is actualized. This setting recreates the balanced sound of a studio listening room.

### USERS:

You can select this only when you have adjusted the curve. Refer to "Adjusting and Saving the Target Curve" (page 19).

- If you are not satisfied with the measurement result, click [Re-Measure] to perform measurement again.

## 19 Click [Send Filter].

The Memory selection screen will be displayed.



- 20** Select and click the memory where the curve is to be saved from [ImprintEQ Memory 1] or [ImprintEQ Memory 2]. Click [OK].

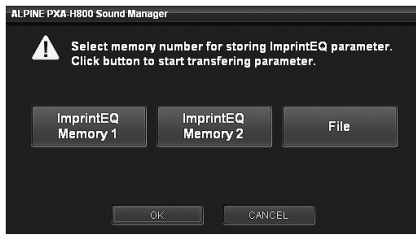

- Select [File] to save ImprintEQ measurement data on a PC. Refer to “Saving ImprintEQ Measurement Data on a PC” (page 19).

- 21** Click [Close Window].

- To enable this function, Defeat should be is set to ON.
- Graphic EQ, Parametric EQ and X-Over Level are set to their initial values during ImprintEQ measurement.
- The file extension of the ImprintEQ setting data file is “.ieq”.
- When you save the measurement result of ImprintEQ in Memory 1 or 2 for the second time, the memory will be overwritten and the previous data will be lost.
- Sound may arrive at the listening position at slightly different times, depending on the speaker and enclosure. To compensate for this, the distance can be adjusted to be larger than the actual distance.
- Measurement values will not be lost in the event the system is reset or battery power is disconnected.

## Turning ImprintEQ On/Off

- 1** Click [ImprintEQ] for [Shortcut] tab in the main menu.  
The Automatic Measurement tab screen will be displayed.
  - When you click [Automatic Measurement] in the Function switching tab, the Automatic Measurement tab screen will also be displayed. Refer to “Operating the Function Switching Tab” (page 7).
- 2** Click [ON] or [OFF] for “ImprintEQ.”  
If you click [ON], select the setting value.
- 3** Click [▼] and select and click either [Memory 1] or [Memory 2].

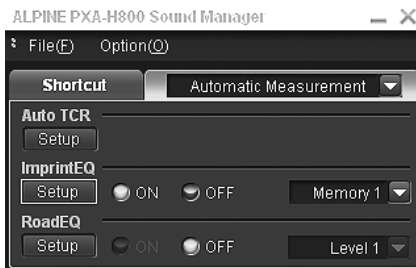

- If you do not use ImprintEQ is not used, select [OFF].
- If the speaker system in the “Memory” and the current speaker system do not match, the Memory cannot be retrieved.
- When you turn on ImprintEQ, the Graphic EQ, Parametric EQ, Time Correction, and Output Level are automatically adjusted. Each of these values can be further adjusted, but the adjustment ranges for the Graphic EQ and the Parametric EQ are restricted.
- When ImprintEQ is on, the Time Correction and X-Over channel will be automatically set at the L/R Separate Adjustment mode.

- After the setting, it is recommended to store the setting contents on the unit. For details, refer to “Storing the Preset Values (Preset Store)” (page 12).

## Saving ImprintEQ Measurement Data on a PC

- 1** Click [File] in Step 20 for “Setting ImprintEQ”, and click [OK].  
The “Save As” box will be shown.
- 2** Select the location where you want to save the file and enter a name for the file to save.
  - For the method to load the data saved on a PC, refer to “Loading the ImprintEQ Measurement Data (File)” (page 11).

## Adjusting and Saving the Target Curve

You can adjust the target curve and save it on a PC.

- 1** Click [Target Curve Setting] in Step 17 for “Setting ImprintEQ.”  
The Target Curve Setting screen will be displayed.
  - When you click [Target Curve] for the [Shortcut] tab in the main menu, the Target Curve Setting screen will be displayed.
- 2** Drag the curve to adjust it.

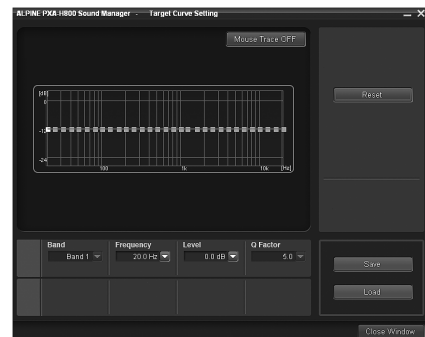

Setting contents: -6 to +6dB

- 3** Click [Save].  
The “Save As” box will be shown.
- 4** Select the location where you want to save the file and enter a name for the file to save.
  - The file extension of the measurement data file is “.tcv”.
  - You can retrieve the saved data by clicking [Load].
  - To restore the target curve to the initial settings, click [Reset]. Click [OK] when confirmation message appears.
  - **Mouse trace function**  
When you click [Mouse Trace OFF], the mouse trace function becomes enabled, and [Mouse Trace OFF] changes to [Mouse Trace ON]. When dragged, the curve (settings) changes in accordance with the movement of the cursor.  
To disable the mouse trace function, click the [Mouse Trace ON].

## Adjusting the Time Correction Automatically (Auto TCR)

A vehicle poses a unique listening environment. Speaker distances vary widely to each listening position. These special conditions can be overcome using the included microphone and the powerful measurement system in this processor. The processor measures and analyzes data automatically to optimize time correction for each speaker and listening position selected.

### 1 Preparing for measurement.

- Park the vehicle in a quiet location.
- Close doors, windows, sunroof, etc.
- Turn the air-conditioner and heater OFF.
- Turn off the engine of the vehicle.

### 2 Preparing the microphone.

Place the microphone at the listening position (driver's seat, etc.). A camera tripod is recommended for this purpose.

- *The microphone should be placed at shoulder height.*
- *When you save the measurement data values for various listening positions in the preset, you can easily load one of them as necessary.*

### 3 Turn the Ignition switch of the vehicle to ACC (On).

- *If an air-conditioner or heater is turned on, turn it off. Measurement should not be performed if air-conditioner or heater noise is present.*

### 4 Click [Auto TCR] for [Shortcut] tab in the main menu.

The Automatic Measurement tab screen will be displayed.

- *When you click [Automatic Measurement] in the Function switching tab, the Automatic Measurement tab screen will also be displayed. Refer to "Operating the Function Switching Tab" (page 7).*

### 5 Click [Setup] for "Auto TCR."

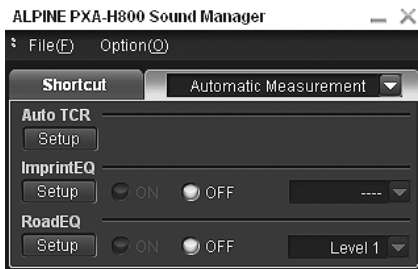

### 6 When the confirmation message is displayed, check the content and click [OK].

### 7 When the confirmation message is displayed again, check the content and click [OK].

### 8 Click [START] in the measurement start screen.

Countdown will start.



During the 10 second countdown, go outside the vehicle and close the door.

A test signal will be output from the speakers to measure the acoustic characteristics of the cabin. Do not open any doors until the finish message appears on the screen. If external noise interferes with the measurement. If the error screen is displayed, perform the measurement again.

- *If you want to stop measurement, click [CANCEL].*
- *If no microphone is connected, a confirmation message will be displayed and measurement will not be carried out. Click [OK] to cancel the indication.*

### 9 When a confirmation message for closing the screen is displayed, click [OK].

- *To enable this function, Defeat should be is set to ON.*
- *Measurement of Auto TCR takes approximately 5 minutes.*
- *Auto TCR measurement result overwrites the manual TCR measurement result.*
- *Sound may arrive at the listening position at slightly different times, depending on the speaker and enclosure. To compensate for this, the distance can be adjusted to be larger than the actual distance.*
- *After the setting, it is recommended to store the setting contents on the unit. For details, refer to "Storing the Preset Values (Preset Store)" (page 12).*

## Adjusting for Road Noise (RoadEQ)

RoadEQ (REAL-TIME OPTIMIZED ADAPTIVE DRIVING EQ) is a function to automatically adjust the EQ properties in accordance with the road noise while driving.

The Road Equalizer compensates for constantly changing noise, so always keep the microphones connected.

### 1 Preparing for measurement.

- Park the vehicle in a quiet location.
- Close doors, windows, sunroof, etc.
- Turn the air-conditioner and heater OFF.
- Turn off the engine of the vehicle.

### 2 Preparing the microphone.

Refer to the installation manual.

### 3 Turn the ignition switch of the vehicle to ACC (On).

- *If an air-conditioner or heater is turned on, turn it off. Measurement should not be performed if air-conditioner or heater noise is present.*

### 4 Click [RoadEQ] for [Shortcut] tab in the main menu.

The Automatic Measurement tab screen will be displayed.

- *When you click [Automatic Measurement] in the Function switching tab, the Automatic Measurement tab screen will also be displayed. Refer to "Operating the Function Switching Tab" (page 7).*

## 5 Click [Setup] for “RoadEQ.”

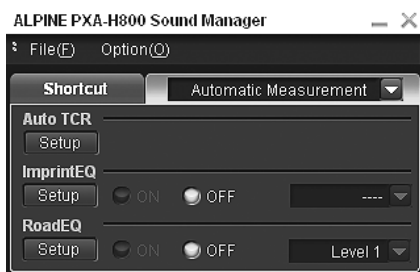

## 6 When a confirmation message is displayed, check the content and click [OK].

## 7 Click [START] in the measurement start screen.

Countdown will start.

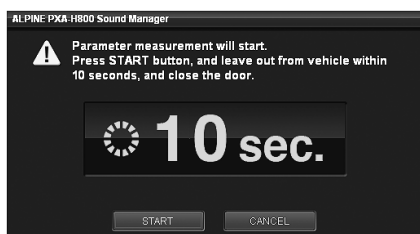

During the 10 second countdown, go outside the vehicle and close the door.

A test signal will be output from the speakers to measure the acoustic characteristics of the cabin. Do not open any doors until the finish message appears on the screen. If external noise interferes with the measurement. If the error screen is displayed, perform the measurement again.

- If you want to stop measurement, click [CANCEL].
- If no microphone is connected, a confirmation message will be displayed and measurement will not be carried out. Click [OK] to cancel the indication.

## 8 When a confirmation message for closing the screen is displayed, click [OK].

- To enable this function, Defeat should be is set to ON.
- Measurement of RoadEQ takes approximately 7 minutes.
- Measurement values will not be lost in the event the system is reset or battery power is disconnected.

## Turning RoadEQ On/Off

When automatic measurement is completed, RoadEQ can be turned on or off and its level can be selected.

### 1 Click [RoadEQ] for [Shortcut] tab in the main menu.

The Automatic Measurement tab screen will be displayed.

- When you click [Automatic Measurement] in the Function switching tab, the Automatic Measurement tab screen will also be displayed. Refer to “Operating the Function Switching Tab” (page 7).

### 2 Click [ON] or [OFF] for “RoadEQ.”

When you click [ON], select the level.

- When you do not use RoadEQ, select [OFF].

### 3 Click [▼] and select and click either [Level 1], [Level 2], or [Level 3].

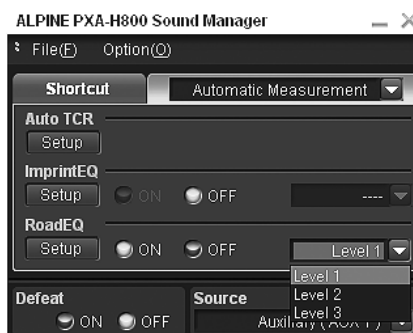

Level 1: Low correction level. Suitable for quiet vehicles.

Level 2: Moderate correction level.

Level 3: High correction level. Suitable for high speed driving.

- If measurement is not completed, or a microphone is not connected, this setting cannot be performed.
- When you change the speaker setting of On/Off, RoadEQ automatically becomes off. When you have changed the speaker settings, start the measurement step over again.
- After the setting, it is recommended to store the setting contents on the unit. For details, refer to “Storing the Preset Values (Preset Store)” (page 12).

# Audio Setup/ Adjustment

## Setting MX Plus (Ai-NET Mode)

MX (Media Xpander) Plus enhances the vocal and instrumental sounds for music sources such as radio/CD/MP3, by generating harmonics lost during digital processing. This high frequency compensation adds clarity and detail normally lost to road noise.

This feature becomes enabled when an Ai-NET compatible head unit with MX Plus linking function is connected. If MX Plus mode is set for each source beforehand, it automatically switches according to the music source of the head unit.

- When a head unit with the MX Plus linking function, such as INA-W910, is connected, it should be set to Ai-NET mode. Other head units should be set in the Standalone mode.

- 1 Click [MX Plus] for [Shortcut] tab in the main menu.**  
MX Plus setup screen will be displayed.
- When you click [Media Sound Manager] on the Function switching tab, and then [Setup], the MX Plus setup screen will also be displayed. Refer to "Operating the Function Switching Tab" (page 7).
- 2 Click [ON] for "MX Plus" in the main menu.**  
MX Plus becomes enabled.
- When you click the [OFF], MX Plus for all music sources becomes will be disabled.
- 3 Click [Ai-NET] for "MX Plus Setup" in the main menu.**  
MX Plus will become linked to the head unit.
- 4 Click [▼] for "Level Adjustment" in the setup screen, and select and click the level from the pull-down menu.**



MX Plus level increases in the following order: 1 → 2 → 3.

### FM (Level 1 to 3, OFF):

The medium to high frequencies become clearer, and produces well balanced sound at all frequencies.

### CD (Level 1 to 3, OFF):

CD mode processes a large amount of data during playback. MX Plus takes advantage of this large data quantity to reproduce a more clear, clean output.

### Compressed Data/Digital Radio (Level 1 to 3, OFF):

This corrects information that was lost at the time of compression. This reproduces a well-balanced sound close to the original.

### DVD (Cinema, Action, Music, OFF):

#### Cinema:

Movie dialogue is clearly reproduced. Action movies are reproduced with more powerful sound.

#### Action:

Action movies are reproduced with more powerful sound.

#### Music:

Lower register sounds (drums, bass, etc.) and vocals are emphasized for clean and clear output.

### AUX / Others (Compressed, Music, DVD, OFF):

MX mode suitable for the media (Compressed Data, Music, DVD) can be selected.

- When "OFF" is selected, MX Plus becomes disabled.

## 5 When setting is complete, click [Close Window].

- To enable this function, Defeat should be is set to ON.
- After the setting, it is recommended to store the setting contents on the unit. For details, refer to "Storing the Preset Values (Preset Store)" (page 12).

## Setting MX Plus (Standalone Mode)

MX (Media Xpander) Plus enhances the vocal and instrumental sounds for music sources such as radio/CD/MP3, by generating harmonics lost during digital processing. This high frequency compensation adds clarity and detail normally lost to road noise.

In the Standalone mode, MX Plus does not become linked with the source of the head unit. MX Plus should be set for each external input. MX Plus mode will be switched, linked with the source switching of PXA-H800.

- 1 Click [MX Plus] for [Shortcut] tab in the main menu.**  
MX Plus setup screen will be displayed.
  - When you click [Media Sound Manager] on the Function switching tab, and then [Setup], the MX Plus setup screen will also be displayed. Refer to "Operating the Function Switching Tab" (page 7).
  - 2 Click [ON] for "MX Plus" in the main menu.**  
MX Plus becomes enabled.
  - When you click the [OFF], MX Plus for all music sources becomes will be disabled.
- If an Ai-NET compatible head unit is connected, go to step 3.**  
**If an Ai-NET compatible head unit is not connected, go to step 4.**
- 3 Click [Standalone] for "MX Plus Setup" in the main menu.**

- When a head unit without the MX Plus linking function is connected, this should be set as "Standalone," even if it is an Ai-NET compatible head unit.

- 4 Click [▼] for “Level Adjustment” for each external input in the setup screen and select and click the level from the pull-down menu.

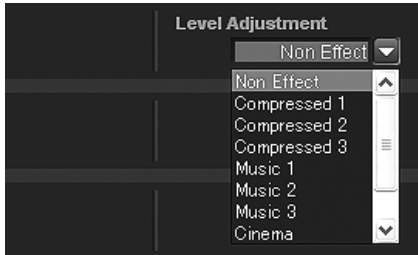

MX Plus level increases in the following order: 1 → 2 → 3.

#### Compressed 1 to 3:

This corrects information lost in the compression process. This reproduces a well-balanced sound close to the original. By supplementing mid- to high- frequency sound data, the sound is reproduced with more brightness and ambience.

#### Music 1 to 3:

Lower register sounds (drums, bass, etc.) and vocals are emphasized for clean and clear output.

#### Cinema:

Video dialogue is reproduced more clearly. Action movies are reproduced with more powerful sound.

#### Action:

Action movies are reproduced with more powerful sound.

#### Drama/Talk:

The dialogue portion of a video is reproduced more clearly.

- When “Non Effect” is selected, MX Plus becomes disabled.
- External Inputs to be set vary depending on the system set in “Setting the AUX Input System (AUX Input System Select)” (page 14).

### 5 When setting is complete, click [Close Window].

- To enable this function, Defeat should be is set to ON.
- After the setting, it is recommended to store the setting contents on the unit. For details, refer to “Storing the Preset Values (Preset Store)” (page 12).

## Setting the Graphic EQ

The graphic equalizer allows you to modify the sound using 31 bands each for the front (left and right), rear (left and right) and center speakers. An additional 10 bands are available for the subwoofer. This allows you to customize the sound to suit your taste.

### 1 Click [G.EQ] for [Shortcut] tab in the main menu.

The EQ Setup screen is displayed.

- When you click [Mobile Sound Manager] on the Function switching tab, and then [EQ Setup], the EQ Setup screen will also be displayed. Refer to “Operating the Function Switching Tab” (page 7).

### 2 Click [G.EQ] in the main menu.

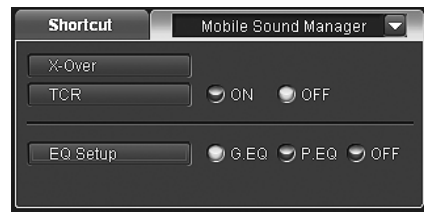

The EQ mode switches to the Graphic EQ mode.

- You can choose either Graphic EQ or Parametric EQ. When you click [OFF], EQ mode becomes disabled.

### 3 Click either [☞] or [☞].

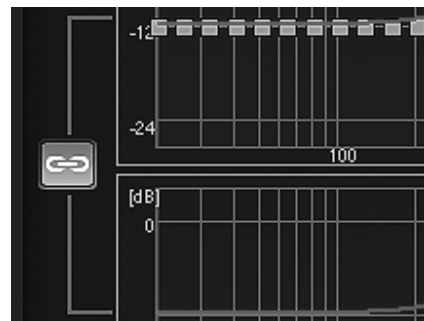

[☞]: Both R and L channels are set at the same value (The initial setting).

[☞]: Channels R and L can be set independently.

- When you select “[☞]” a message to confirm which of the R or L channel set up values is to be applied will be displayed. Click either [LEFT] or [RIGHT].

### 4 Click the channel you want to adjust.

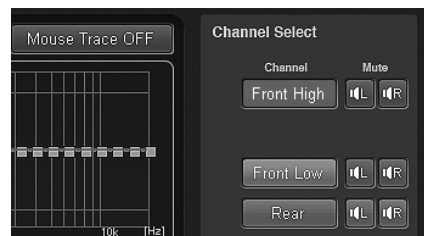

- Channels to be set vary depending on the system set in “Setting the Speaker System (Output System Select)” (page 13).

## 5 Click a frequency and drag up or down to adjust the level.

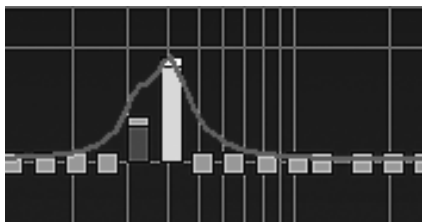

Frequency:

Front/Rear/Center: 20Hz~20kHz (1/3 octave step)  
(1 to 31 Band)

SubW: 20Hz to 160Hz (1/3 octave step)  
(1 to 10 Band)

Level: -12 to +12dB (in 0.5dB step)\*

\* When *ImprintEQ* is enabled, -6 to +6 dB (in 0.5 dB steps)

### • Mouse trace function

When you click [Mouse Trace OFF], the mouse trace function becomes enabled, and [Mouse Trace OFF] changes to [Mouse Trace ON]. When dragged, the curve (settings) changes in accordance with the movement of the cursor.

To disable the mouse trace function, click the [Mouse Trace ON].

- You can also make adjustments by operating the settings indication area (Frequency, Level).

The current setup value will be displayed at the bottom of the Screen. Click [▼] and select and click a setup value. You can also use the [Tab], [←], [→], [↑], and [↓] keys on your PC to select the setup value.



## 6 To adjust another channel, repeat Steps 4 through 5.

- You can listen with Defeat OFF (adjusted setup values) or with Defeat ON (Initial value) to compare, by clicking either [ON] or [OFF] of “Defeat” in the main menu while in the adjustment mode.
- By clicking either [L] or [R] of “Mute” while in the adjustment mode, you can mute the selected channel.



## 7 When setting is complete, click [Close Window].

- To enable this function, Defeat should be set to ON.
- To restore the channel which is currently being adjusted to the default, click [Ch. Flat]. To restore all the channels to the initial settings, click [All Reset]. Click [OK] when each confirmation message appears.
- When the speaker is set to the “OFF” mode, the graphic equalizer for that speaker cannot be set. Refer to “Setting the Speaker System (Output System Select)” (page 13)/ “Setting the Speakers (Speaker Setup)/Setting the Subwoofers” (page 14).
- Check the playable frequency ranges of the connected speakers before making equalizer adjustments. If the speaker’s playable frequency range is 55 Hz to 30 kHz, for example, adjusting the 40 Hz or 20 Hz band has no effect. Additionally, you may overload and damage the speakers.

- After the setting, it is recommended to store the setting contents on the unit. For details, refer to “Storing the Preset Values (Preset Store)” (page 12).

## Displaying the data

### 1 Click [Show All Data].

The setup values for all the channels will be displayed.

Channel	Band	Freq	Gain/Level	Q Factor
1	20	20	0	5
2	25	25	0	5
3	31.5	31.5	0	5
4	40	40	4.5	5
5	50	50	2	5
6	63	63	2.5	5
7	80	80	2	5
8	100	100	1.5	5
9	125	125	0.5	5
10	160	160	0	5
11	200	200	-2	5
12	250	250	-4	5
13	315	315	-4	5
14	400	400	-15	5
15	500	500	-6.5	5
16	630	630	-15	5
17	800	800	-25	5
18	1000	1000	-11.5	5
19	1200	1200	-12	5
20	1600	1600	-12	5
21	2000	2000	-12	5



## Setting the Parametric EQ

The frequency bands of the graphic equalizer are fixed. This makes it very difficult to correct for undesired peaks and dips at specific frequencies. The parametric equalizer's center frequency can be tuned to these specific frequencies. Then, the bandwidth (Q) and level are fine-tuned, independently, to make the necessary corrections. The parametric equalizer function is an advanced tool for serious audiophiles.

### 1 Click [P.EQ] for [Shortcut] tab in the main menu.

The EQ Setup screen is displayed.

- When you click [Mobile Sound Manager] on the Function switching tab, and then [EQ Setup], the EQ Setup screen will also be displayed. Refer to "Operating the Function Switching Tab" (page 7).

### 2 Click [P.EQ] in the main menu.



The EQ mode switches to the Parametric EQ mode.

- You can choose either Graphic EQ or Parametric EQ. When you click [OFF], EQ mode becomes disabled.

### 3 Click either [☺] or [☹].

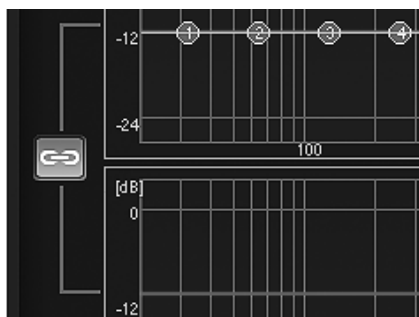

☺: Both R and L channels are set at the same value (The initial setting).

☹: Channels R and L can be set independently.

- When you select "☺" a message to confirm which of the R or L channel set up values is to be applied will be displayed. Click either [LEFT] or [RIGHT].

### 4 Click the channel you want to adjust.

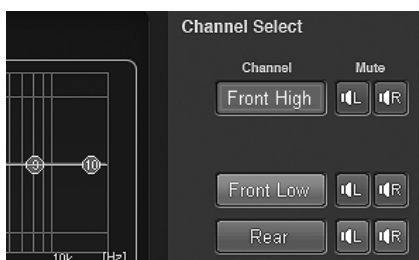

- Channels to be set vary depending on the system set in "Setting the Speaker System (Output System Select)" (page 13).

- ### 5 Click each band and drag up or down to adjust the level. Drag to the right or left to adjust the frequency. Adjust the bandwidth (Q) by dragging diagonally on the curve.



- Band: Front/Rear/Center: 1 to 10  
SubW: 1 to 5
- Frequency: Front/Rear/Center: 20 Hz to 20kHz (in 1/6 octave steps)  
SubW: 20 Hz to 200 Hz (in 1/6 octave steps)
- Level: -12 to +12 dB (in 0.5 dB steps)\*
- Q Factor: 0.5/1.0/1.5/2.0/2.5/3.0/4.0/5.0
- \* When *InprintEQ* is enabled, 6 to +6 dB (in 0.5 dB steps)

- You can also make adjustments by operating the settings indication area. The current setup value will be displayed at the bottom of the screen. Click [▼] and select and click a setup value. You can also use the [Tab], [←], [↓], [↑], and [↓] keys on your PC to select the setup value.

L ch.	Band	Frequency	Level	Q Factor
	Band 4	280.0 Hz	+7.0 dB	0.5
R ch.	Band	Frequency	Level	Q Factor
	Band 4	280.0 Hz	+7.0 dB	0.5

### 6 To adjust another channel, repeat Steps 4 through 5.

- You can listen with Defeat OFF (adjusted setup values) or with Defeat ON (Initial value) to compare, by clicking either [ON] or [OFF] of "Defeat" in the main menu while in the adjustment mode.
- By clicking either [L] or [R] of "Mute" while in the adjustment mode, you can mute the selected channel.

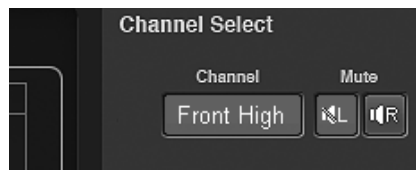

### 7 When setting is complete, click [Close Window].

- To enable this function, Defeat should be is set to ON.
- To restore the channel which is currently being adjusted to the default, click [Ch. Flat]. To restore all the channels to the initial settings, click [All Reset]. Click [OK] when each confirmation message appears.
- When the speaker is set to the "OFF" mode, the parametric equalizer for that speaker cannot be set. Refer to "Setting the Speaker System (Output System Select)" (page 13)/ "Setting the Speakers (Speaker Setup)/Setting the Subwoofers" (page 14).
- Check the playable frequency ranges of the connected speakers before making equalizer adjustments. If the speaker's playable frequency range is 55 Hz to 30 kHz, for example, adjusting the 40 Hz or 20 Hz band has no effect. Additionally, you may overload and damage the speakers.
- If you boost the sound too much in the same frequency range, distortion may occur.

- After the setting, it is recommended to store the setting contents on the unit. For details, refer to “Storing the Preset Values (Preset Store)” (page 12).

### Displaying the data

#### 1 Click [Show All Data].

The setup values for all the channels will be displayed.

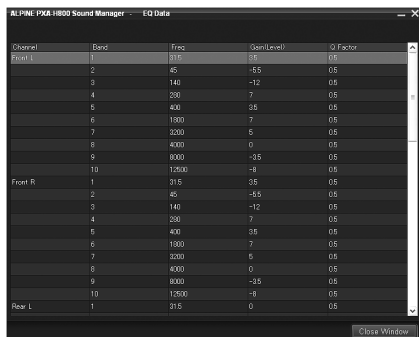

## About the Crossover (X-Over)

### Crossover (X-Over):

This unit is equipped with an active crossover. The crossover limits the frequencies delivered to the outputs. Each channel is controlled independently. Thus, each speaker pair can be driven by the frequencies for which they have been optimally designed.

The crossover adjusts the HPF (high pass filter) or LPF (low pass filter) of each band, and also the slope (how fast the filter rolls off the highs or lows).

Adjustments should be made according to the reproduction characteristics of the speakers. Depending on the speakers, a passive network may not be necessary. If you are unsure about this point, please consult your authorized Alpine dealer.

	Cutoff frequency adjustment range (1/6 octave steps)	
	HPF	LPF
Front High	20Hz to 18kHz	22Hz to 20kHz
	1kHz to 18kHz (Tweeter only)	1.1kHz to 20kHz (Tweeter only)
Front Mid	20Hz to 18kHz	22Hz to 20kHz
Front Low	20Hz to 18kHz	22Hz to 20kHz
Rear	20Hz to 18kHz	22Hz to 20kHz
Center	20Hz to 18kHz	22Hz to 20kHz
Subwoofer	20Hz to 180Hz	22Hz to 200Hz

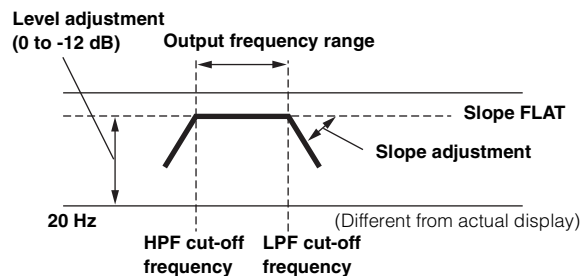

- **HPF (high pass filter):** Cuts the lower frequencies and allows the higher frequencies to pass.
- **LPF (low pass filter):** Cuts the higher frequencies and allows the lower frequencies to pass.
- **Slope:** The level change (in dB) for a frequency change of one octave.

- The higher the slope value, the steeper the slope becomes.
- Adjust the slope to FLAT (0 dB/oct) to bypass the HP or LP filters.
- Do not use a tweeter without the HPF on or set to a low frequency, as it may cause damage to the speaker due to the low frequency content.
- You cannot adjust the crossover frequency higher than the HPF or lower than the LPF.
- Adjustment should be made according to the recommended crossover frequency of the connected speakers. Determine the recommended crossover frequency of the speakers. Adjusting to a frequency range outside that recommended may cause damage to the speakers. For the recommended crossover frequencies of Alpine speakers, refer to the respective Owner's Manual. We are not responsible for damage or malfunction of speakers caused by using the crossover outside the recommended value.

## Adjusting X-Over and Switching the Phases

This section describes how to adjust X-Over. Before working on this, refer to “About the Crossover (X-Over)” (page 26).

### Hint for adjusting the subwoofer

If the subwoofer is installed on the rear deck, setting a gentle L.P.F. slope (for example 6 dB/ oct.) makes the sound localization more to the rear. This can also affect the acoustic localization of the front.

### Hints for adjusting the high range

Depending on the speaker, inputting low frequency component signals (about 2 kHz or less) with the H.P.F. adjustment could result in distortion. If so, set a steep slope (for example 30 dB/oct.).

### When doing so, adjust so that the mid and high range sounds do not separate.

Normally use with the L.P.F. off. If the high range is too strong, we recommend adjusting for a gentle slope.

### Hint for adjusting the low range

When a subwoofer is connected and you are using a speaker with a low range of under 10 or 12 cm (3-15/16" or 4-3/4"), setting the low range H.P.F. to "OFF" can result in distortion when low frequency components are input. If so, set the H.P.F. slope to a value suited for the speaker's frequency response.

#### 1 Click [X-Over] for [Shortcut] tab in the main menu.

The X-Over Setup screen is displayed.

- When you click [Mobile Sound Manager] on the Function switching tab, and then [X-Over], the X-Over Setup screen will also be displayed. Refer to “Operating the Function Switching Tab” (page 7).

#### 2 Click either [↔] or [↔].

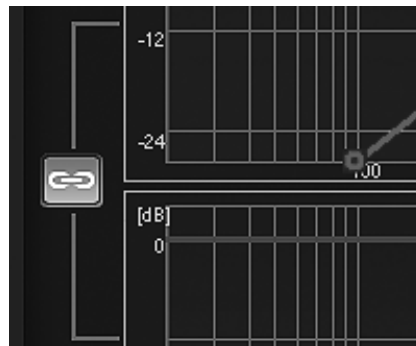



: Both R and L channels are set at the same value (The initial setting).

: Channels R and L can be set independently.

- When you select “,” a message to confirm which of the R or L channel set up values is to be applied will be displayed. Click either [LEFT] or [RIGHT].

**3 Click the channel you want to adjust.**

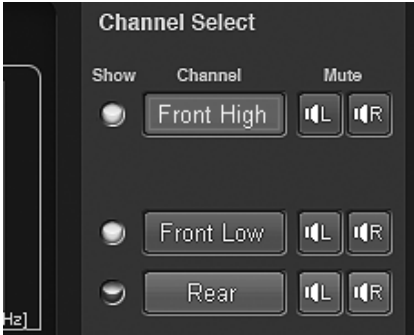

- Channels to be set vary depending on the system set in “Setting the Speaker System (Output System Select)” (page 13).

**4 Drag the setup point up or down or to the right or left to make adjustments.**

The arrow indicating the dragging direction appears.

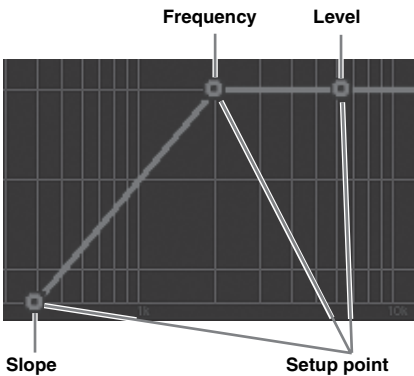

The cutoff frequency band varies depending on the channel (speaker) (see “About the Crossover (X-Over)” page 26).

Slope: 0 (OFF)/-6/-12/-18/-24/-30/-36 dB/oct\*

Level: -24 to 0dB (in 0.5 dB steps)

\* Neither LPF of Subwoofer nor HPF of Front High can be set at 0 (OFF).

- **Show All Curves:**  
When you click the [Show All Curves], the curves for all the channels will be displayed.
- **Hide Other Curves:**  
When you click the [Hide Other Curves], only the curve of the channel for which you are making adjustments is displayed.
- You can also make adjustments by operating the settings indication area.

The current setup value will be displayed at the bottom of the Screen. Click [▼] and select and click a setup value. You can also use the [Tab], [←], [→], [↑], and [↓] keys on your PC to select the setup value.



- The unadjusted curve display can be turned off in the following steps.
  - 1 Click the indicator of “Show.”

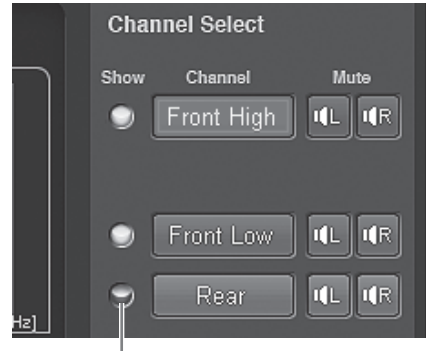

**Indicator**

The indicator will be turned off and the curve display of the selected channel is hidden.

- 2 To turn on the display, click the indicator of “Show” again.

**5 Click [0°] or [180°] to switch the phase.**

**6 To adjust another channel, repeat Steps 3 through 5.**

- By clicking either [L] or [R] of “Mute” while in the adjustment mode, you can mute the selected channel.



**7 When setting is complete, click [Close Window].**

- To restore the channel which is currently being adjusted to the default, click [Ch. Flat]. To restore all the channels to the initial settings, click [All Reset]. Click [OK] when each confirmation message appears.
- When Tweeter is selected for “Front 1” to protect the speaker, there is no filter off (Slope OFF) setting for HPF. There is no filter off (Slope OFF) setting for Subwoofer LPF, either.
- When the speaker is set to the “OFF” mode, the X-Over for that speaker cannot be set. Refer to “Setting the Speaker System (Output System Select)” (page 13)/ “Setting the Speakers (Speaker Setup)/ Setting the Subwoofers” (page 14).
- Check the playback frequencies of the connected speakers before adjusting.
- After the setting, it is recommended to store the setting contents on the unit. For details, refer to “Storing the Preset Values (Preset Store)” (page 12).

## Displaying the data

### 1 Click [Show All Data].

The setup values for all the channels will be displayed.

Channel	HPT. Freq.	HPT. Slope	LPT. Freq.	LPT. Slope	GainLevel	Phase
Front High L	1500	-18	2000	0	0	ANGLE_D
Front High R	1500	-18	2000	0	0	ANGLE_D
Front Low L	20	-12	400	-24	-15	ANGLE_D
Front Low R	20	-12	400	-24	-15	ANGLE_D
Rear L	20	-18	700	-36	-105	ANGLE_D
Rear R	20	-18	700	-36	-105	ANGLE_D
Subwoofer L	20	0	180	-36	-75	ANGLE_D
Subwoofer R	20	0	180	-36	-75	ANGLE_D

## Adjusting the Time Correction (TCR)

Because of the particular conditions inside the vehicle, there are major differences in the distances between the different speakers and the various listening positions. The proper time correction can be obtained using the automatic time correction function ("Auto TCR"), but it is also possible to calculate the optimum correction values and eliminate the time error at the listening position using this function.

The unit for the time correction can be chosen to be either "cm" or "inch." (Initial setting: "cm")

### ■ Calculation of time correction

1 Sit in the listening position (the driver's seat, for example) and measure the distance (in meters) between your head and the various speakers.

2 Calculate the difference in distance between the farthest speaker and the other speakers.

$L = (\text{distance of farthest speaker}) - (\text{distance of other speakers})$

3 Divide the distances calculated for the different speakers by the speed of sound (343 m/s temperature 20°C).

This value is the time correction value for the different speakers.

### Concrete examples

1 Calculating the time correction value for the front left speaker on the diagram below.

Conditions:

Distance between farthest speaker and listening position: 2.25 m (88-3/4")

Distance between front left speaker and listening position: 0.5 m (20")

Calculation:  $L = 2.25 \text{ m} (88-3/4") - 0.5 \text{ m} (20") = 1.75 \text{ m} (68-3/4")$

Compensation time =  $1.75 \div 343 \times 1000 = 5.1 \text{ (ms)}$

In other words, setting the time correction value for the front left speaker to 5.1 (ms) sets a virtual distance matching the distance to the farthest speaker.

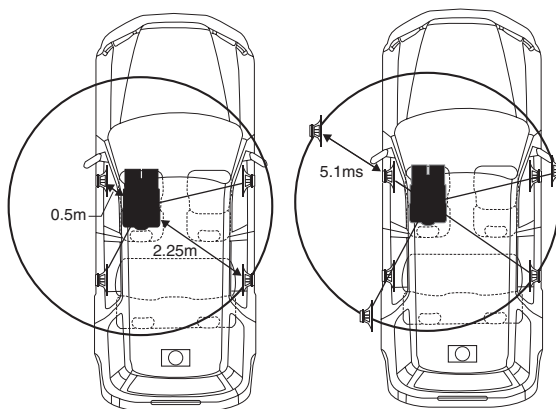

The sound is uneven because the distance between the listening position and the different speakers is different.

The difference in the distance between the front left and rear right speakers is 1.75 meters (68-3/4").

Time correction eliminates the difference between the time required for the sound from the different speakers to reach the listening position.

Setting the time correction of the front left speaker to 5.1 ms makes it possible to coordinate the distance from the listening position to the speaker.

### ■ Entering the time correction

4 Click [TCR] for [Shortcut] tab in the main menu.

The TCR Setup screen is displayed.

- When you click [Mobile Sound Manager] on the Function switching tab, and then [TCR], the TCR Setup screen will also be displayed. Refer to "Operating the Function Switching Tab" (page 7).

5 Click [ON] for "TCR" in the main menu.

- Choose OFF to disable the TCR function.

6 Click either [↔] or [↔].

[↔]: Both R and L channels are set at the same value (The initial setting).

[↔]: Channels R and L can be set independently.

- When you select "[↔]," a message to confirm which of the R or L channel set up values is to be applied will be displayed. Click either [LEFT] or [RIGHT].

## 7 Click either [cm] or [inch.]



cm: The unit for the time correction becomes "cm."  
inch: The unit for the time correction becomes "inch."

## 8 Drag [●] of the channel you want to adjust to the right or left. Or click either [↔] or [↔] to set.



The time correction value.

Setting contents: 0.00 to 20.00 ms (in 0.05 ms steps)

- Channels to be set vary depending on the system set in "Setting the Speaker System (Output System Select)" (page 13).
- By clicking [Mute] while in the adjustment mode, you can mute the selected channel. Click [Mute] again to output audio.
- You can listen with Defeat OFF (adjusted setup values) or with Defeat ON (Initial value) to compare, by clicking either [ON] or [OFF] of "Defeat" in the main menu while in the adjustment mode.

## 9 When setting is complete, click [Close Window].

- To enable this function, Defeat should be set to ON.
- When the speaker is set to the "OFF" mode, the time correction for that speaker cannot be set. Refer to "Setting the Speaker System (Output System Select)" (page 13)/ "Setting the Speakers (Speaker Setup)/Setting the Subwoofers" (page 14).
- Sound may arrive at the listening position at slightly different times, depending on the subwoofer and enclosure. After this setting, preview the sound and adjust as necessary. A correction of 10ms (135.0 inch/ 343.0 cm) may be necessary.
- After the setting, it is recommended to store the setting contents on the unit. For details, refer to "Storing the Preset Values (Preset Store)" (page 12).

## Entering numerical values

You can directly enter the distances (actual measurements) to all the speakers to make adjustments.

### 1 Click [Value Input].

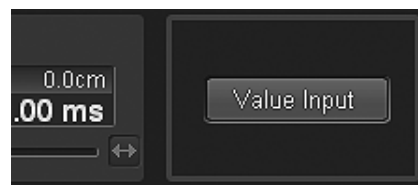

### 2 Click [cm] or [inch].

### 3 Enter the number directly or click [^] or [v] to enter the actual measurements (distances to the speakers).

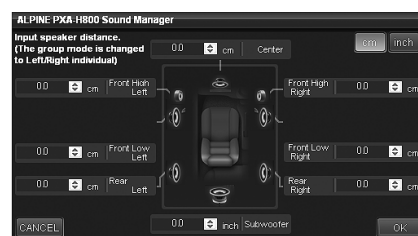

Setting contents:

inch: 0.0 to 270.1  
cm: 0.0 to 686.0

### 4 Click [OK].

The mode will change to the channel L/R individual adjustment mode. The number you enter will be reflected in the setting screen.

# Use the Multi Channel Function

## Setting the 2-Channel Signal Playback Mode (2ch Playback Mode)

These steps set the 2-channel signal playback mode.

### 1 Click [Multi Channel Manager] of the Function switching tab.

Multi Channel Manager tab screen will be displayed.

- Refer to "Operating the Function Switching Tab" (page 7).

### 2 Set and adjust "2ch Playback Mode," "EUPHONY," "Dolby Pro Logic II."

- When both Rear and Center speakers are off in "Setting the Speaker System (Output System Select)" (page 13)/ "Setting the Speakers (Speaker Setup)/Setting the Subwoofers" (page 14), this item cannot be set.
- After the setting, it is recommended to store the setting contents on the unit. For details, refer to "Storing the Preset Values (Preset Store)" (page 12).

## Setting the 2-Channel Signal Playback Mode (2ch Playback Mode)

When playing back 2-Channel Stereo, select a playback mode best suited to the music. (Initial setting: "Stereo")

### 1 Click [▼] for "2ch Playback Mode" and select and click the playback mode you want from the pull-down menu.

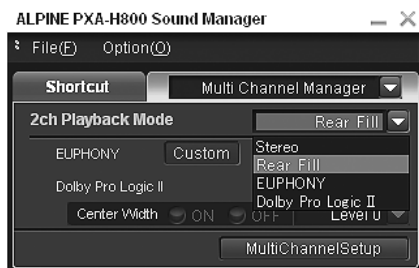

Setting contents: Stereo/Rear Fill/EUPHONY/Dolby Pro Logic II

- Stereo:** Plays back in 2ch stereo.
- Rear Fill:** Outputs the front signal from the rear.
- EUPHONY:** Plays back in 5.1 channel surround (page 30).
- Dolby Pro Logic II:** Plays back in Dolby Pro Logic II surround (page 31).

- For linear PCM, the front signals are sent to the rear channel even if the system is set up for "Stereo."
- "Rear Fill" function  
Depending on the input signals, the sound may only be output from the front speakers. In this case, the "Rear Fill" function can be used to output signals from the rear speakers as well.

- If the setting of Rear Fill is made when Rear Mix is ON, sound is unchanged in the rear fill setting because Rear Mix is given priority during 2 channel decoder other than linear PCM.

## Setting EUPHONY (EUPHONY)

EUPHONY creates 5.1 channel surround using Adaptive Surround technology based on a music signal recorded in 2-channel.

When you set up EUPHONY and play back a CD or iPod stereo source, you can enjoy the realistic sensation of musicians playing around you. For DVD movie playback, you can enjoy the sense of localization of the dialogue and impressive three-dimensional sound effects.

In this setting, EUPHONY Mode can be selected. (Initial setting: "ACOUSTIC")

### 1 Click [▼] for "2ch Playback Mode" and select and click [EUPHONY] from the pull-down menu.



- If you click [EUPHONY] for [shortcut] tab in the main menu, the Multi Channel Manager tab screen can also be displayed and you can set up EUPHONY.

### 2 Click [▼] for "EUPHONY" and select and click the mode from the pull-down menu.



Setting contents: ACOUSTIC/LIVE/CINEMA/TV SHOW/  
Custom 1/Custom 2/Custom 3

- ACOUSTIC:** Localization is emphasized; the mode with regular sound field resonance.
- LIVE:** Ambience is emphasized; the mode in which sound field resonance is more strongly felt.
- CINEMA:** Mode suitable for movie audio. Dialogues are reproduced clearly and sound effect is crisp.
- TV SHOW:** Mode suitable for broadcasting audio such as the digital broadcasting.
- Custom 1/Custom 2/  
Custom 3:** These can be selected only when EUPHONY is customized in "Customizing EUPHONY" (page 31).

- This function only works with 2-channel signals.

## Customizing EUPHONY

You can customize the sense of ambience (localization and ambience) of the cabin sound field and the balance (Level) between surround channels and save the settings.

### 1 Click [Custom] for “EUPHONY.”

The EUPHONY custom screen is displayed.



### 2 Click [Standard], [Wide], or [Off] in the “Localization/Ambience” to choose the localization/ambience.

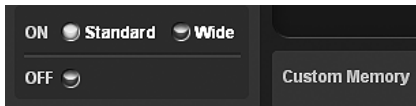

Standard: Setup of the regular ambience of Ls/Rs sound. Choose this for a subtle expansion in sound.

Wide: The ambience of Ls/Rs sound is more easily recognizable. Use this when you want brightness and crispness.

Off: This disables EUPHONY.

### 3 Adjust the localization/ambience for each channel. Drag [●] for “Localization/Ambience” or click [▲] or [▼].

Setting channel: C (Center), L (Left Front) / R (Right Front),  
Ls (Left Surround) /Rs (Right Surround)  
Setting contents: 0.0 to 1.0 (in 0.05 steps)

### 4 Click either [☺] or [☹] for “L/R Group.”



☺: Both R and L channels are set at the same value.

☹: Channels R and L can be set independently.

- When you select “☺,” a message to confirm which of the R or L channel set up values is to be applied will be displayed. Click either [LEFT] or [RIGHT].

### 5 Adjust the level for each channel. Drag [●] for “EUPHONY Output Level” or click [▲] or [▼].

Setting channel: C (Center), L (Left Front) / R (Right Front),  
Ls (Left Surround) /Rs (Right Surround)  
Setting contents: -12 to 0 dB (in 0.05 steps)

### 6 Click [Store] for “Custom Memory” to save the settings.

The Memory selection screen is displayed.

### 7 Click either [Custom 1], [Custom 2], or [Custom 3] and click [OK].

### 8 When setting is complete, click [Close Window].

- This setting is only available for 2-channel signal playback.
- If you click [Call] in Step 6, you can call and readjust the stored setting values. Click either [Custom 1], [Custom 2], or [Custom 3] in the setting value selection screen and click [OK].
- By clicking [Mute] of “Mute” while in the adjustment mode, you can mute the selected channel.

## Using Dolby Pro Logic II (Dolby Pro Logic II)

Pro Logic processing can be applied to the music signals recorded in 2-channel stereo. This gives normal 2-channel stereo a more live, concert hall effect. When you select “Music,” you can adjust the center width. This function provides the optimum vocal localization by adjusting the center channel localization in between the center speaker and the L/R speakers. (Initial setting: “Music”)

### 1 Click [▼] for “2ch Playback Mode” and select and click [Dolby Pro Logic II] from the pull-down menu.



### 2 Click either [Music] or [Movie] for “Dolby Pro Logic II.”



Music: Suits stereo TV shows and all programs encoded in Dolby Surround. Creates a sound field directivity near that of discrete 5.1-channel sound.

Movie: Can be used for all stereo music recordings, and provides a wide, deep sound field.

- For details on Dolby Pro Logic II, see page 61.
- This function only works with 2-channel signals.

### Adjusting the Center Width (Center Width)

When you select “Music” for “Dolby Pro Logic II,” you can further adjust the center width in the following steps. This function offers the optimum vocal position by adjusting the center channel position between the center speaker and the L/R speaker. (The adjustments established in “Adjusting the Acoustic Image (BI-PHANTOM)” (page 33) are ineffective while this function is activated.) (Initial setting: “OFF”, “Level 0”)

- 1 Click [ON] for “Dolby Pro Logic II” - “Center Width.”
- 2 Click [▼] and select and click a level.



Level settings: Level 0 to Level 7

When the level becomes higher, the center channel localization shifts from the center speaker toward both sides.

- When the Center speaker is off in “Setting the Speaker System (Output System Select)” (page 13)/ “Setting the Speakers (Speaker Setup)/Setting the Subwoofers” (page 14), this item cannot be set.

## Multi Channel Function Adjustment Procedure

Make the adjustments described below in order to reproduce Dolby Digital and DTS sound with greater accuracy.

### Setting the 2-Channel Signal Playback Mode (2ch Playback Mode) (page 30)

This sets the 2-channel signal playback mode.



### Adjusting the Acoustic Image (BI-PHANTOM) (page 33)

Adjusting the acoustic image to achieve a sound as if the center speaker were directly in front of the listener.



### Setting the Linear PCM (PCM Mode) (page 34)

You can choose either 2ch or 3ch for the playback output of a disc recorded on the linear PCM.



### Mixing the Low Range Audio of the Center with the Front L/R (Center Bass Split) (page 34)

Turning this feature on makes the audio signals emitted from the front L/R speakers mixed with the center audio signals (low range).



### Mixing the Low Range Audio for the Rear (Rear Mix) (page 33)

Achieving smooth sound in the rear seat by mixing the front audio signals with the rear speaker signals.



### Achieving Powerful High Volume Sound (Listening Mode) (page 34)

Achieving energetic sound with even greater power, like the sound in a movie theater.



### Adjusting the DVD Level (DVD Level) (page 34)

Adjust the volume signal level in each of the Dolby Digital, Dolby Pro Logic II, DTC and PCM modes.



### Adjusting the Speaker Volume Level (Output Level) (page 33)

Adjust each speaker's volume so they are the same level.



### Storing the Preset Values (Preset Store) (page 12)

Storing all the settings and adjustments made on the PXA-H800 (not only the above settings/adjusts) in the memory.

### In case of combining the Automatic adjustments, etc.

We recommend to make the Automatic adjustments before the Dolby Surround adjustments.

## Multi Channel Setup

These steps set multi channel playback.

- 1 Click [Multi Ch. Setup] for [Shortcut] tab in the main menu.

The Multi Channel Setup screen is displayed.

- When you click [Multi Channel Manager] on the Function switching tab, and then [Multi Channel Setup], the Multi Channel Setup screen will also be displayed. Refer to “Operating the Function Switching Tab” (page 7).

- 2 Set and adjust each item.

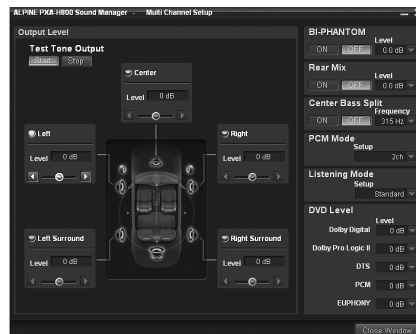

Setting item: Output Level/BI-PHANTOM/Rear Mix/Center Bass Split/PCM Mode/Listening Mode/DVD Level



### 3 When setting is complete, click [Close Window].

- After the setting, it is recommended to store the setting contents on the unit. For details, refer to “Storing the Preset Values (Preset Store)” (page 12).

## Adjusting the Speaker Volume Level (Output Level)

The test tones guide you through the volume adjustments of the different speakers. When levels are balanced, a strong sense of presence can be heard from the different speakers at the listening position. (Initial setting: “±0dB”)

### 1 Click [Start] for “Test Tone Output.”

Output Level screen will be displayed and the test tone is produced from the left front speaker.

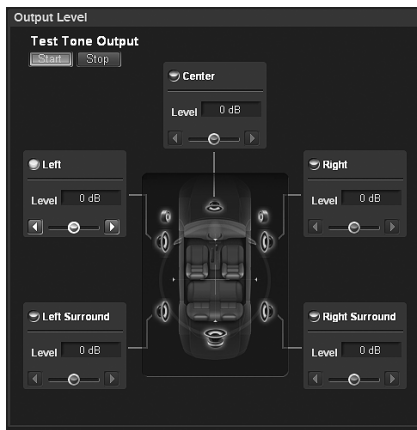

### 2 Select a channel and click.

Setting channel: Left/Center/Right/Right Surround/Left Surround

- Channels to be set vary depending on the system set in “Setting the Speaker System (Output System Select)” (page 13).

### 3 Adjust the speaker volumes for each channel to make them equal while the test tone is output from each channel. Drag [●] or click [◀] or [▶] to make adjustments.

Level: -10 to +10 dB (in 1 dB steps)

Adjust based on the front speakers.

### 4 Repeat Steps 2 and 3 to set the level for each channel.

### 5 To stop the test tone, click [Stop].

- Avoid stopping, pausing, switching the disc, cueing, fast-forwarding or switching the audio channel of this unit while making this adjustment. The setting is cancelled if the decode mode is switched.

## Adjusting the Acoustic Image (BI-PHANTOM)

To install a center speaker, it must be located in the dash, an equal distance between the Left and Right speakers. In most cases, this is very difficult to achieve. Using BI-PHANTOM, a virtual center speaker is created by sending the center channel information to both the Left and Right speakers. Adjusting the center width in Dolby Pro Logic II “Music” (see “Using Dolby Pro Logic II (Dolby Pro Logic II)” on page 31), makes this function ineffective. (Initial setting: “OFF”, “±0dB”)

### 1 Click [ON] for “BI-PHANTOM.”

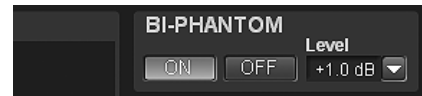

Turning this feature on creates the acoustic image in which the center speaker is virtually located exactly in front of the listener by sending the sound of the center speaker to both sides.

### 2 Click [▼] for “Level” and select and click the level you want from the pull-down menu.

Level: -5 to +5 dB (in 1 dB step)

The level can be adjusted between -5 and +5. When the level becomes greater, the acoustic image moves from the center speaker location towards both sides.

- Avoid stopping, pausing, switching the disc, cueing, fast-forwarding or switching the audio channel of this unit while making this adjustment. The setting is cancelled if the decode mode is switched.
- When the Center speaker is off in “Setting the Speaker System (Output System Select)” (page 13)/ “Setting the Speakers (Speaker Setup)/Setting the Subwoofers” (page 14), this item cannot be set.
- Effective only for Dolby Pro Logic II, EUPHONY and DTS (with Center signal).

## Mixing the Low Range Audio for the Rear (Rear Mix)

This function mixes the front channel audio signals with the audio signals output from the rear speakers, improving the sound in the vehicle’s rear seat. This is used in a system where there is no subwoofer and the rear speakers can produce lower frequency sounds than the front speakers. (Initial setting: “OFF”, “±0dB”)

### 1 Click [ON] for “Rear Mix.”

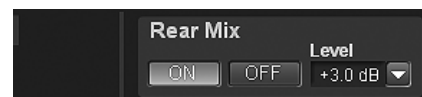

Turning this feature on mixes the audio signals output from the rear speakers with the front audio signals.

### 2 Click [▼] for “Level” and select and click the level you want from the pull-down menu.

Level: -6/-3/0/+3/+6 dB

The level can be adjusted in 5 steps. The higher the level, the more the low range audio is output from the rear speakers. (Depending on the software such as DVD, the effect may vary.)

- Avoid stopping, pausing, switching the disc, cueing, fast-forwarding or switching the audio channel of this unit while making this adjustment. The setting is cancelled if the decode mode is switched.
- When the Rear speaker is off in “Setting the Speaker System (Output System Select)” (page 13)/ “Setting the Speakers (Speaker Setup)/ Setting the Subwoofers” (page 14), this item cannot be set.
- Effective only for Dolby Pro Logic II, EUPHONY and DTS (with rear signal).

## Mixing the Low Range Audio of the Center with the Front L/R (Center Bass Split)

Turning on this function sends the Center channel low frequencies, equally to the front Left and Right speakers. This enhances the overall sound when using a small center speaker. This is used when the center speaker has a small diameter and cannot produce low frequency sounds. (Initial setting: “OFF”, “315 Hz”)

### 1 Click [ON] of “Center Bass Split.”



Turning this feature on mixes the audio signals output from the rear speakers with the front audio signals.

### 2 Click [▼] for “Frequency” and select and click a frequency you want from the pull-down menu.

Frequency:  
200 Hz/225 Hz/250 Hz/280 Hz/315 Hz/350 Hz/400 Hz/450 Hz/500 Hz

- Avoid stopping, pausing, switching the disc, cueing, fast-forwarding or switching the audio channel of this unit while making this adjustment. The effect may not be recognized easily depending on the decoding conditions.
- When the Center speaker is off in “Setting the Speaker System (Output System Select)” (page 13)/ “Setting the Speakers (Speaker Setup)/Setting the Subwoofers” (page 14), this item cannot be set.
- Effective only for Dolby Pro Logic II, EUPHONY and DTS (with Center signal).

## Setting the Linear PCM (PCM Mode)

The output can be set to 2 or 3 channels when playing discs recorded in linear PCM. (Initial setting: “2ch”)

### 1 Click [▼] for “PCM Mode” and click either [2ch] or [3ch] from the pull-down menu.

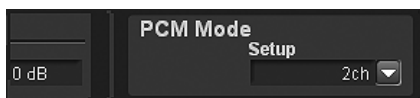

2ch: 2ch Output (L/R)  
3ch: 3ch Output (L/R/CENTER)

- When the Center speaker is off in “Setting the Speaker System (Output System Select)” (page 13)/ “Setting the Speakers (Speaker Setup)/Setting the Subwoofers” (page 14), this item cannot be set.

## Achieving Powerful High Volume Sound (Listening Mode)

With Dolby Digital, the dynamic range is compressed so that powerful sound can be achieved at regular volume levels. This compression can be cancelled to achieve an energetic sound with even greater power, like the sound in a movie theater. This function works only in the Dolby Digital mode. (Initial setting: “Standard”)

### 1 Click [▼] for “Listening Mode” and click either [Standard] or [Maximum] from the pull-down menu.



Standard: To enjoy the dynamic sound at regular volume  
Maximum: To enjoy the dynamic sound at maximum volume

- This feature is effective only for Dolby Digital.
- Use this feature at a volume level at which you can still hear sound outside of the cabin.
- Depending on the types of source, such as DVD software, this feature may be ineffective.

## Adjusting the DVD Level (DVD Level)

The volume level for Dolby Digital, Dolby Pro Logic II, DTS, EUPHONY and PCM modes can be set. (Initial setting: “±0dB”)

### 1 Click [▼] for “DVD Level” and select and click the level of mode you want from the pull-down menu.

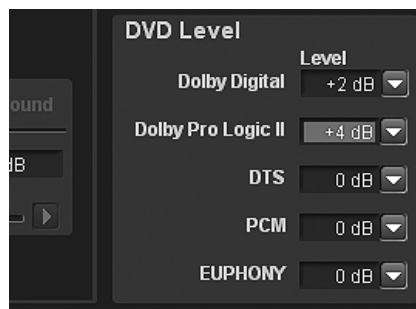

Adjustment modes: Dolby Digital/Dolby Pro Logic II/DTS / PCM/EUPHONY

Level: -10 to +10 dB (in 1 dB steps)

- Avoid stopping, pausing, switching the disc, cueing, fast-forwarding or switching the audio channel of this unit while making this adjustment. The effect may not be recognized easily depending on the decoding conditions.



# Basic Operation

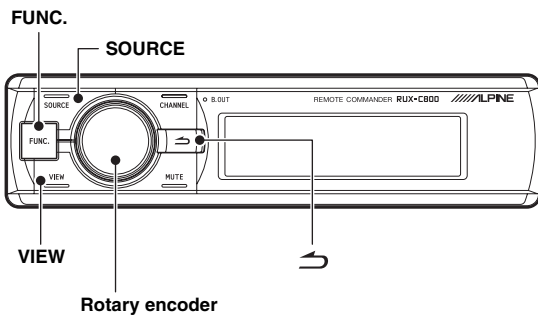

Rotary encoder

## ■ About the Commander display <Items that have been selected>



## <Items that have not been selected>



## Initial System Start-Up

If the system stops working properly, turn the ignition switch to off, and then on again. If the system still does not work properly, reset the unit.

### 1 Press RESET switch with a ballpoint pen or similar pointed object.

<Right side>

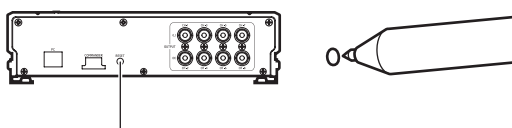

RESET switch

The system will be reset and restarted.

- Reset when power is off.
- Resetting does not erase the settings stored in the system.

## Using with Ai-NET Connections

When the unit is connected to the head unit through Ai-NET, some operations can be controlled with the head unit.

The following operations are controlled with the head unit. The Commander and PC will no longer control these when the head unit is connected.

- Turning Power On and Off (page 35)
- Switching the Sources (page 36)
- Adjusting Subwoofer/Balance/Fader/Volume (page 35, 36)

You can set Defeat (page 36) and Calling of the stored settings (Preset Call) (page 37) with the head unit, Commander, or PC.

- Please refer to the Owner's Manual of the head unit.

## Turning Power On and Off

When you turn on the power for the first time, to protect the speakers, no sound is output until you select the system in "Setting the Speaker System (System Select)" (page 37)/ "Setting the AUX Input System (AUX Input Setup)" (page 39) and set them. First, set the speaker system / input system.

You cannot turn power on/off from the PC. When an Ai-NET compatible head unit is connected, the power of the unit is linked with the power of the head unit.

- 1 Turn the ignition key to the ACC or ON position.  
The power turns on.
- 2 Press and hold [SOURCE] for at least 2 seconds to turn off the unit.

- Either switch will turn the power on.
- When the ignition key is turned to off, the power of the unit is also turned off.

## Audio Adjustment

- 1 Press the [Rotary encoder] repeatedly.



Select the adjusting mode.

SUBWOOFER\*1 → NAVI LEVEL\*2 → MX PLUS SETUP (LEVEL ADJUSTMENT)\*3 → BALANCE → FADER → DEFEAT → VOLUME → SUBWOOFER

\*1 This is not displayed when the subwoofer is off.

\*2 This is not displayed when "Mixing Navi Audio Guidance (Navi Mix Setup)" (page 41) is off.

\*3 This is not displayed when MX Plus is off.

- 2 Rotate the [Rotary encoder].

Select the level you want.

- Volume can be adjusted by rotating the rotary encoder without selecting the Volume mode.
- If there is no operation within 5 seconds, the adjustment mode is cancelled.

## Adjusting Subwoofer (SUBWOOFER)

Adjust the subwoofer output (Initial setting: "00").

Setting contents: 00 to 15

- When an Ai-NET compatible head unit is connected, the audio settings are adjusted at the head unit and you cannot set them on the unit itself.

## Navigation Audio Volume Adjustment (NAVI LEVEL)

Adjusts the Navigation audio guidance volume (Initial setting: "0 dB").

Setting contents: -10 to +10 dB

## Adjusting the MX Plus Level (MX PLUS SETUP/LEVEL ADJUSTMENT)

Adjust the MX Plus level. In the Ai-NET mode, the adjustment is performed for the current source (Initial setting: "OFF" / "Non Effect").

### When an Ai-NET compatible head unit is connected:

Setting item: DVD: OFF/Cinema/Action/Music  
 AUX/Others: OFF/Compressed/Music/  
 DVD  
 CD/Compressed Data/FM/Digital Radio:  
 OFF/Level1/Level2/Level3

### When an Ai-NET compatible head unit is not connected:

Setting item: Non Effect/Compressed 1/Compressed 2/  
 Compressed 3/Music 1/Music 2/Music 3/  
 Cinema/Action/Drama/Talk

- For MX Plus, refer to "Setting the MX Plus (Ai-NET Mode)" (page 44) and "Setting the MX Plus (Standalone Mode)" (page 45).

## Adjusting Balance (Between Left and Right) (BALANCE)

Adjust the Right and Left speaker volume (Initial setting: "0").

Setting contents: L (Left) 15 to 0 (Center) to R (Right) 15

- When an Ai-NET compatible head unit is connected, the audio settings are adjusted at the head unit and you cannot set them on the unit itself.

## Adjusting Fader (Between Front and Rear) (FADER)

Adjust the Front and Rear speaker volume (Initial setting: "0").

Setting contents: F (Front) 15 to 0 (Center) to R (Rear) 15

- When an Ai-NET compatible head unit is connected, the audio settings are adjusted at the head unit and you cannot set them on the unit itself.

## Setting Defeat (DEFEAT)

When is set to "ON", the settings for ImprintEQ, Graphic EQ, Parametric EQ, MX Plus, RoadEQ, and Time Collection are restored to the initial values (Initial setting: "OFF").

Setting contents: ON/OFF

## Adjusting Volume (VOLUME)

Adjust the volume (Initial setting: "-∞ dB").

Setting contents: -∞ to 0.0 dB

- When an Ai-NET compatible head unit is connected, the audio settings are adjusted at the head unit and you cannot set them on the unit itself.

## Switching the Sources

The unit accepts up to five analog signal input lines and 2 digital signal input lines. For the connection, refer to the installation manual. When an Ai-NET compatible head unit is connected, the source should be switched at the head unit. This feature is disabled on the Commander.

### 1 Press [SOURCE].

Each push switches the source.

AUX1 → AUX2 → AUX3 → Ai-NET(HU) → Ai-NET(CHG)  
 → DIGITAL1 → DIGITAL2 → AUX1

- The number of analog signal inputs varies depending on the setting in "Setting the AUX Input System (AUX Input Setup)" (page 39).
- Only the sources set as ON in "Setting the AUX Input (AUX IN)" (page 39) and "Setting the Digital Input (Digital AUX)" (page 40) are displayed.
- Names selected in "Naming the AUX Input (AUX Name)" (page 41) are displayed as the source names.

## Storing the Preset Values (Preset Store)

You can store up to 6 sets of the adjustment/setting values. All of the following adjustment/setting values are stored in a single preset memory.

Adjustment/Setup items	Pages
Setting the Speaker System (System Select)	37
Setting the Speakers(Speaker Setup)	38
Setting the Subwoofer Output (SW Channel)	38
Setting the AUX Input System (AUX Input Setup)	39
Setting the AUX Input (AUX IN)	39
Setting the Digital Input (Digital AUX)	40
Setting the AUX Volume Input Level (AUX IN Gain)	40
Adjusting the AUX Volume Level (AUX Level)	40
Naming the AUX Input (AUX Name)	41
Turning ImprintEQ On/Off	42
Turning RoadEQ On/Off	43
Setting the MX Plus (Ai-NET Mode)	44
Setting the MX Plus (Standalone Mode)	45
Setting the Equalizer Mode (EQ Mode)	46
Setting the Graphic EQ	46
Setting the Parametric EQ	47
Adjusting X-Over and Switching the Phases	49
Adjusting the Time Correction (TCR)	50
Setting the 2-Channel Signal Playback Mode (Mode)	52
Setting EUPHONY (EUPHONY)	52
Using Dolby Pro Logic II (Dolby PLII)	53
Adjusting the Center Width (Center Width)	53
Adjusting the Speaker Volume Level (Output Level)	54
Adjusting the Acoustic Image (BI-PHANTOM)	55
Mixing the Low Range Audio for the Rear (Rear Mix)	55
Mixing the Low Range Audio of the Center with the Front L/R (Center Bass Split)	56
Setting the Linear PCM (PCM Mode)	56
Achieving Powerful High Volume Sound (Listening Mode)	56
Adjusting the DVD Level (DVD Level)	57

### 1 Adjust the value you want to store and set it.

### 2 Press [FUNC.].

### 3 Rotate the [Rotary encoder] to select "Preset," and then press the [Rotary encoder].

### 4 Rotate the [Rotary encoder] to select "Store," and then press the [Rotary encoder].



- 5 Select one from “P.1” through “P.6” by rotating the [Rotary encoder], and press the [Rotary encoder].

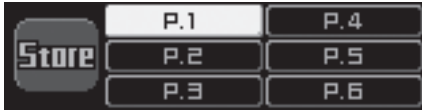

The data is stored in the selected preset number.

- The function is operable when Defeat is set to OFF.
- The stored contents are not deleted even when resetting the unit or disconnecting the battery.

## Recalling a Stored Setting (Preset Call)

The preset memory stores various setting/adjustment information. Thus, it takes some time to call data from the preset memory.

- 1 Press and hold [VIEW] for at least 2 seconds.
- 2 Select a preset from “P.1” through “P.6” by rotating the [Rotary encoder], and press the [Rotary encoder].



The values of the selected preset number are retrieved.

- You can call the Preset even by the following procedure:
  - 1 Press [FUNC.].
  - 2 Rotate the [Rotary encoder] to select “Preset,” and then press the [Rotary encoder].
  - 3 Rotate the [Rotary encoder] to select “Call,” and then press the [Rotary encoder].
  - 4 Select a preset from “P.1” through “P.6” by rotating the [Rotary encoder], and press the [Rotary encoder].  
The values of the selected preset number are retrieved.
- The function is operable when Defeat is set to OFF.
- If the speaker system in the preset and the current speaker system do not match, the preset cannot be retrieved.
- If the AUX input system in the preset and the current AUX input system do not match, the items concerning the AUX input system are unavailable for retrieval.

## Setting the Speaker System (System Select)

First, set the system and the speakers. Unless you set the system, you cannot set any features. Be sure to set the system first. If the selected system and the connections of the speakers do not match, the speakers may be damaged. Make sure to check the connections of the speakers before selecting the system.

Only for the initial startup:

- 1 Press the [FUNC.] or [Rotary encoder].  
The Output System selection screen is displayed. Go to Step 3.

- 1 Press [FUNC.].
- 2 Rotate the [Rotary encoder] to select “Output Setup,” and then press the [Rotary encoder].
- 3 Rotate the [Rotary encoder] to select “System Select,” and then press the [Rotary encoder].



The Output System selection screen is displayed.

- 4 Rotate the [Rotary encoder] to select a system, and then press the [Rotary encoder].

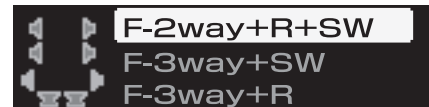

- F-2way+R+SW: 4.2ch system (Front2Way+Rear+Subwoofer)
- F-3way+SW: 2.2ch system (Front3Way+Subwoofer)
- F-3way+R: 4.0ch system (Front3Way+Rear)
- F-2way+R+C+SW: 5.1ch system (Front2Way+Rear+Center+Subwoofer)

- Refer to Table 1 (Output System) in “System Configuration” (page 60).

- 5 Select “OK” by rotating the [Rotary encoder] when a confirmation message appears, and press the [Rotary encoder].

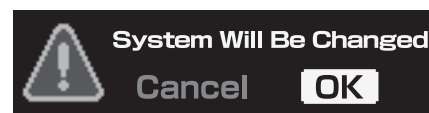

The Speaker Setup screen is displayed.

- When “OK” is selected, the audio output is stopped until the ignition key is turned on/off.

- 6 Turn off any unconnected speakers. Rotate the [Rotary encoder] to select “ON” or “OFF,” etc., and then press the [Rotary encoder].



Repeat the steps until all the speakers are set.

- FRONT HIGH\*1: OFF/Tweeter/Full
- FRONT LOW: OFF/ON
- REAR: OFF/ON
- CENTER: OFF/ON
- SUBWOOFER(1, 2): OFF/ON
- SW CHANNEL: Mono/Stereo\*2

\*<sup>1</sup> When you modify the “FRONT HIGH” speaker setting to [Full], a message to confirm the change will be displayed. To set up at “Full Range,” rotate the [Rotary encoder] to select “OK”, and then press the [Rotary encoder]. Make sure the speaker being used for this output is able to handle a full range source. Many tweeters can be damaged when driven by a full range signal.

\*<sup>2</sup> This item is enabled for setup only when 2 subwoofers are connected. Rotate the [Rotary encoder] to select “Stereo” or “Mono”, and then press the [Rotary encoder].

Stereo: Subwoofer stereo (L/R) output  
Mono: Subwoofer monaural output

- Speakers that cannot be turned off are disabled for setup. Refer to Table 1 (Output System) in “System Configuration” (page 60).
- When you connect just one subwoofer, turn off “Subwoofer2.”

## 7-1 First time start-up:

The AUX Input System Select screen will be automatically displayed. Continue to set, referring to “Setting the AUX Input System (AUX Input Setup)” (page 39).

## 7-2 Subsequent start-up:

The “Turn ACC Off” screen will be displayed. Turn the ignition key to off and then on again. The settings become effective.

- If [↵] is pressed during setting, the unit returns to the previous item.
- If the speaker system is changed, all setup values except those for AUX input will be restored to the initial setup values.
- You can also set the speakers from “Setting the Speakers (Speaker Setup)” (page 38).
- You can also set the subwoofer output from “Setting the Subwoofer Output (SW Channel)” (page 38).
- After the setting, it is recommended to store the setting contents on the unit. For details, refer to “Storing the Preset Values (Preset Store)” (page 36).

## Setting the Speakers (Speaker Setup)

Turn on the connected speakers.

- 1 Press [FUNC.].
- 2 Rotate the [Rotary encoder] to select “Output Setup,” and then press the [Rotary encoder].
- 3 Rotate the [Rotary encoder] to select “Speaker Setup,” and then press the [Rotary encoder].

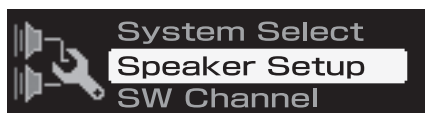

The Speaker selection screen is displayed.

- 4 Rotate the [Rotary encoder] to select the speaker to be set, and then press the [Rotary encoder].

Setting contents: Front High/Front Mid/Front Low/Rear/  
Center/Subwoofer (1, 2)

- Speakers to be set vary depending on the system set in “Setting the Speaker System (System Select)” (page 37).
- Speakers that cannot be turned off are disabled for setup. Refer to Table 1 (Output System) in “System Configuration” (page 60).

- 5 Rotate the [Rotary encoder] to select “ON” or “OFF,” etc., and then press the [Rotary encoder].

Repeat the steps until all the speakers are set.

Front High*:	OFF/Tweeter/Full
Front Low:	OFF/ON
Rear:	OFF/ON
Center:	OFF/ON
Subwoofer(1, 2):	OFF/ON

\* When you modify the “Front High” speaker setting to [Full], a message to confirm the change will be displayed. To set up at “Full Range,” rotate the [Rotary encoder] to select “OK”, and then press the [Rotary encoder]. Make sure the speaker being used for this output is able to handle a full range source. Many tweeters can be damaged when driven by a full range signal.

- When you connect just one subwoofer, turn off “Subwoofer2.”

- 6 To set up other speakers, press [↵] and repeat Steps 4 and 5.

- 7 When the setting is complete, press and hold [↵] for at least 2 seconds.

- If [↵] is pressed during setting, the unit returns to the previous item.
- When the speaker setting is changed while ImprintEQ/RoadEQ is on, ImprintEQ/RoadEQ will be turned off after a confirmation message is displayed.
- After the setting, it is recommended to store the setting contents on the unit. For details, refer to “Storing the Preset Values (Preset Store)” (page 36).

## Setting the Subwoofer Output (SW Channel)

You can set the subwoofer output to stereo or monaural. Make sure to set the correct output for your subwoofer type. (Initial Setting: “Mono”)

- 1 Press [FUNC.].
- 2 Rotate the [Rotary encoder] to select “Output Setup,” and then press the [Rotary encoder].
- 3 Rotate the [Rotary encoder] to select “SW Channel,” and then press the [Rotary encoder].



The Subwoofer Channel selection screen is displayed.

- 4 Rotate the [Rotary encoder] to select “Mono” or “Stereo,” and then press the [Rotary encoder].



Mono: Subwoofer monaural output  
Stereo: Subwoofer stereo (L/R) output

## 5 When the setting is complete, press and hold [↵] for at least 2 seconds.

- Only when two subwoofers are connected in “Setting the Speaker System (System Select)” (page 37)/“Setting the Speakers (Speaker Setup)” (page 38), is this item able to be set.
- If [↵] is pressed during setting, the unit returns to the previous item.
- After the setting, it is recommended to store the setting contents on the unit. For details, refer to “Storing the Preset Values (Preset Store)” (page 36).

## Setting the AUX Input System (AUX Input Setup)

This step sets the six channel Analog (RCA) input of the unit. The input volume levels can also be set.

At the initial startup, the AUX Input System Select screen is displayed automatically after the speakers are set. Go to Step 3.

- 1 Press [FUNC.].
- 2 Rotate the [Rotary encoder] to select “Input Setup,” and then press the [Rotary encoder].
- 3 Rotate the [Rotary encoder] to select “AUX Input Setup,” and then press the [Rotary encoder].  
The AUX Input setup screen is displayed.
- 4 Rotate the [Rotary encoder] to select the desired system, and then press the [Rotary encoder].

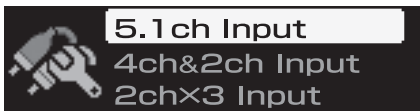

- 5.1ch Input: AUX1 (Front Left, Front Right, Rear Left, Rear Right, Center, Subwoofer)
- 4ch&2ch Input: AUX1 (Front Left, Front Right, Rear Left, Rear Right)/AUX2 (Left, Right)
- 2chx3 Input: AUX1 (Left, Right)/AUX2 (Left, Right)/AUX3 (Left, Right)

- Refer to Table 2 (Input Configuration) in “System Configuration” (page 60).

## 5 Select “OK” by rotating the [Rotary encoder] when a confirmation message appears, and press the [Rotary encoder].

The AUX IN Gain Setup screen is displayed.

- When “OK” is selected, the audio output is stopped until the ignition key is turned on/off.

## 6 Select either “High” or “Low” for each AUX by rotating the [Rotary encoder], and press the [Rotary encoder].



High: When the volume level of the external input is high.

Low: When the volume level of the external input is low.

## 7 The “Turn ACC Off” screen will be displayed. Turn the ignition key to and then on again.

The settings become effective.

- If [↵] is pressed during setting, the unit returns to the previous item.
- Gain can also be set in “Setting the AUX Volume Input Level (AUX IN Gain)” (page 40).
- When the AUX input system is changed, all the setup values for AUX input will be restored to the initial setup values.
- After the setting, it is recommended to store the setting contents on the unit. For details, refer to “Storing the Preset Values (Preset Store)” (page 36).

## Setting the AUX Input (AUX IN)

A TV or VCR with RCA audio output can be connected to the unit. Select OFF for the external input not connected (Initial setting: “ON”).

- 1 Press [FUNC.].
- 2 Rotate the [Rotary encoder] to select “Input Setup,” and then press the [Rotary encoder].
- 3 Rotate the [Rotary encoder] to select “AUX IN,” and then press the [Rotary encoder].  
The AUX selection screen is displayed.
- 4 Select the AUX you want to set by rotating the [Rotary encoder], and press the [Rotary encoder].



Settings item: AUX 2/AUX 3/Ai-NET(HU)/Ai-NET(CHG)

- AUX1 cannot be set.
- If you connect Ai-NET/RCA Interface cable (KCA-121B) to the terminals of the device Head Unit input terminal (Ai-NET input) / Changer input terminal (Ai-NET input), you can use it as AUX.
- The number of AUX varies depending on the AUX Input Setup (page 39).

## 5 Rotate the [Rotary encoder] to select “ON” or “OFF”, and then press the [Rotary encoder].

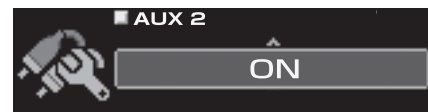

## 6 To set another AUX, press [↵] and repeat Steps 4 and 5.

## 7 When the setting is complete, press and hold [↵] for at least 2 seconds.

- When an Ai-NET compatible head unit is connected, external input of the PXA-H800 becomes unavailable, and this setting will be disabled.
- If [↵] is pressed during setting, the unit returns to the previous item.
- After the setting, it is recommended to store the setting contents on the unit. For details, refer to “Storing the Preset Values (Preset Store)” (page 36).

## Setting the Digital Input (Digital AUX)

A TV or VCR with RCA audio output can be connected to the unit. Select OFF for any external input that is not connected (Initial setting: "ON").

- 1 Press [FUNC.].
- 2 Rotate the [Rotary encoder] to select "Input Setup," and then press the [Rotary encoder].
- 3 Rotate the [Rotary encoder] to select "Digital AUX," and then press the [Rotary encoder].  
The AUX selection screen is displayed.
- 4 Rotate the [Rotary encoder] to select "Digital 1," and then press the [Rotary encoder].



- 5 Rotate the [Rotary encoder] to select "ON" or "OFF," and then press the [Rotary encoder].



- 6 Press [↵].
- 7 Rotate the [Rotary encoder] to select "Digital 2," and then press the [Rotary encoder].
- 8 Rotate the [Rotary encoder] to select "ON" or "OFF," and then press the [Rotary encoder].
- 9 When the setting is complete, press and hold [↵] for at least 2 seconds.

- When an Ai-NET compatible head unit is connected, external input of the PXA-H800 becomes unavailable, and this setting will be disabled.
- If [↵] is pressed during setting, the unit returns to the previous item.
- After the setting, it is recommended to store the setting contents on the unit. For details, refer to "Storing the Preset Values (Preset Store)" (page 36).

## Setting the AUX Volume Input Level (AUX IN Gain)

If the external input audio becomes distorted, select High. (Initial setting: "High")

- 1 Press [FUNC.].
- 2 Rotate the [Rotary encoder] to select "Input Setup," and then press the [Rotary encoder].
- 3 Rotate the [Rotary encoder] to select "AUX IN Gain," and then press the [Rotary encoder].  
The AUX selection screen is displayed.

- 4 Select the AUX you want to set by rotating the [Rotary encoder], and press the [Rotary encoder].

Settings item: AUX 1, AUX 2, AUX 3

- The number of AUX varies depending on the AUX Input Setup (page 39).

- 5 Rotate the [Rotary encoder] to select "High" or "Low", and then press the [Rotary encoder].



High: When the volume level of the external input is high.  
Low: When the volume level of the external input is low.

- 6 To set another AUX, press [↵] and repeat Steps 4 and 5.

- 7 When the setting is complete, press and hold [↵] for at least 2 seconds.

- If [↵] is pressed during setting, the unit returns to the previous item.
- After the setting, it is recommended to store the setting contents on the unit. For details, refer to "Storing the Preset Values (Preset Store)" (page 36).

## Adjusting the AUX Volume Level (AUX Level)

You can adjust the volume signal level of the external RCA input. Adjust this when the volume is higher or lower compared to that of the optical digital product. (Initial setting: "0 dB")

- 1 Press [FUNC.].
- 2 Rotate the [Rotary encoder] to select "Input Setup," and then press the [Rotary encoder].
- 3 Rotate the [Rotary encoder] to select "AUX Level," and then press the [Rotary encoder].  
The AUX Selection screen is displayed.
- 4 Select the AUX you want to set by rotating the [Rotary encoder], and press the [Rotary encoder].

Settings item: AUX 1/AUX 2/AUX 3/Ai-NET(HU)/Ai-NET(CHG)

- The number of AUX varies depending on the AUX Input Setup (page 39).

- 5 Adjust the volume level by rotating the [Rotary encoder].



Setting contents: -10 to +10 dB

- 6 To set another AUX, press [↵] and repeat Steps 4 and 5.



**7** When the setting is complete, press and hold [↵] for at least 2 seconds.

- If [↵] is pressed during setting, the unit returns to the previous item.
- After the setting, it is recommended to store the setting contents on the unit. For details, refer to “Storing the Preset Values (Preset Store)” (page 36).

## Naming the AUX Input (AUX Name)

When you connect an external input product, you can assign it a name of your choice. After setting the value to ON in “Setting the AUX Input (AUX IN)” (page 39), “Setting the Digital Input (Digital AUX)” (page 40), set this item (Initial setting: “Auxiliary”).

- 1** Press [FUNC.].
  - 2** Rotate the [Rotary encoder] to select “Input Setup,” and then press the [Rotary encoder].
  - 3** Rotate the [Rotary encoder] to select “AUX Name,” and then press the [Rotary encoder].  
The AUX selection screen is displayed.
  - 4** Select the AUX you want to set by rotating the [Rotary encoder], and press the [Rotary encoder].  
Settings item: AUX 1/AUX 2/AUX 3/Ai-NET(HU)/Ai-NET(CHG)/Digital 1/Digital 2
- The number of AUX varies depending on the AUX Input Setup (page 39).
- 5** Select from “Auxiliary,” “TV,” “EXT.DVD,” “Portable,” and “Game” by rotating the [Rotary encoder], and press the [Rotary encoder].



**6** To set another AUX, press [↵] and repeat Steps 4 and 5.

**7** When the setting is complete, press and hold [↵] for at least 2 seconds.

- When an Ai-NET compatible head unit is connected, the audio settings are adjusted at the head unit, and you cannot set them on the unit itself.
- If [↵] is pressed during setting, the unit returns to the previous item.
- After the setting, it is recommended to store the setting contents on the unit. For details, refer to “Storing the Preset Values (Preset Store)” (page 36).

## Mixing Navi Audio Guidance (Navi Mix Setup)

When a navigation system is connected, its voice guidance will be mixed with the system and output from the front speakers (Initial setting: “OFF”). You can adjust the navigation guidance volume. (Initial setting: “0 dB”)

- 1** Press [FUNC.].
- 2** Rotate the [Rotary encoder] to select “Input Setup,” and then press the [Rotary encoder].
- 3** Rotate the [Rotary encoder] to select “Navi Mix Setup,” and then press the [Rotary encoder].  
The NAVI MIX SETUP screen is displayed.
- 4** Rotate the [Rotary encoder] to select “ON” or “OFF,” and then press the [Rotary encoder].



OFF: No mixing of the navigation voice guidance.  
ON: Navigation voice guidance is mixed.

- If you select [ON], set the setting value.
- 5** Press [↵] for at least 2 seconds to go back to the normal mode, and repeatedly press the [Rotary encoder].  
The NAVI LEVEL adjustment screen will be displayed.
  - 6** Rotate the [Rotary encoder] to make adjustment.



Setting contents: -10 to +10 dB

**7** When the setting is complete, press [↵].

- If [↵] is pressed during setting, the unit returns to the previous item.
- For the connection of a navigation system, refer to the installation manual.

# Automatic Measurement Function

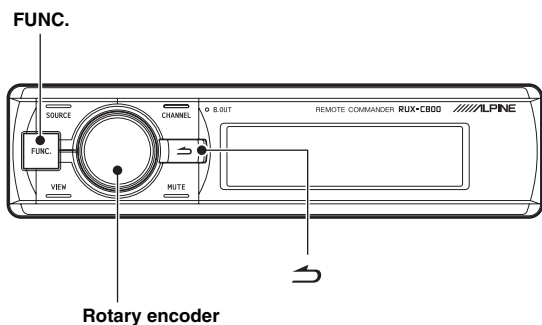

## Before Performing Automatic Measurement

This unit is equipped with ImprintEQ, RoadEQ, and AutoTCR as automatic measurement functions.

- The Commander cannot set ImprintEQ setup. Refer to PC Operation Section "Setting ImprintEQ" (page 17).

### **! WARNING**

- Do not perform automatic measurement while the vehicle is running.  
Do not perform automatic measurement while the vehicle is running. Automatic measurement requires microphones to be installed in the cabin to measure acoustic characteristics, and the speakers may output loud noise for measurement. This may interfere with safe driving and lead to an accident.

### Be sure to read before performing the automatic measurement.

- The automatic measurement should be performed in a quiet place with the engine, air-conditioner, and heater turned off. If a mobile phone or car phone is installed in the vehicle, move them outside of the cabin, or turn the power off. Sound other than the measuring sound (ambient noise around the vehicle, engine noise, and ringtones) may interfere with measurement, resulting in inaccurate measurement of the acoustic characteristics of the cabin.
- Be aware that the battery may be drained if you use the unit for an extended period of time without running the engine.
- The microphone supplied with this product is specifically designed for this type of measurement. Use of any other microphone will give poor or no results. Use of microphones other than the one supplied is not recommended.
- If the system is equipped with a power amplifier with input level control or a powered subwoofer, the measurement may not be possible if the input level is set low. However, to perform correct measurement, the input level should not be set too high.
- For a power amplifier with low-pass filter, turn off the low-pass filter of the power amplifier to make measurement. The low-pass filter in the powered subwoofer or the power amplifier for a subwoofer should be set at the highest cutoff frequency.

### Measurement sequence for the automatic measurement functions

Perform the automatic measurement in the following sequence.

#### **When ImprintEQ is used:**

First, ImprintEQ, then RoadEQ.

#### **When ImprintEQ is not used:**

First, AutoTCR, then RoadEQ.

- When ImprintEQ is used, AutoTCR is not required.
- When ImprintEQ and AutoTCR are performed after RoadEQ, re-perform RoadEQ.

## Turning ImprintEQ On/Off

ImprintEQ setting is performed on a PC. The commander can only switch the ImprintEQ memory settings.

### **1 Press and hold [FUNC.] for at least 2 seconds.**

The memory setting switches with each press.

ImprintEQ 1 → ImprintEQ 2 → ImprintEQ OFF → ImprintEQ 1

ImprintEQ 1/ImprintEQ 2: ImprintEQ ON mode

- Memory settings that do not include ImprintEQ measurement data are skipped.
- For further details on ImprintEQ, refer to PC Operation Section "Setting ImprintEQ" (page 17).

## Adjusting the Time Correction Automatically (Auto TCR)

A vehicle poses a unique listening environment. Speaker distances vary widely to each listening position. These special conditions can be overcome using the included microphone and the powerful measurement system in this processor. The processor measures and analyzes data automatically to optimize time correction for each speaker and listening position selected.

### **1 Preparing for measurement.**

- Park the vehicle in a quiet location.
- Close doors, windows, sunroof, etc.
- Turn the air-conditioner and heater OFF.
- Turn off the engine of the vehicle.

### **2 Preparing the microphone.**

Place the microphone at the listening position (driver's seat, etc.). A camera tripod is recommended for this purpose.

- The microphone should be placed at shoulder height.
- When you save the measurement data values for various listening positions in the preset, you can easily load one of them as necessary.

### **3 Turn the ignition switch of the vehicle to ACC (On).**

- If an air-conditioner or heater is turned on, turn it off. Measurement should not be performed if air-conditioner or heater noise is present.

### **4 Press [FUNC.].**

### **5 Rotate the [Rotary encoder] to select "Sound Field Adj.," and then press the [Rotary encoder].**



- 6** Rotate the [Rotary encoder] to select “Auto TCR,” and then press the [Rotary encoder].



The AUTO TCR screen is displayed.

- 7** Press the [Rotary encoder].  
Countdown will start.



During the 10 second countdown, go outside the vehicle and close the door.

A test signal will be output from the speakers to measure the acoustic characteristics of the cabin. Do not open any doors until the screen indicates “Finished.” If external noise interferes with the measurement, the “Calibration Error” message will appear on the screen. In this case, click [Rotary encoder] again to re-measure.

- If you want to stop measurement, press [↵].
- If the microphone is not connected, “No Mic” will be displayed and the measurement will not be carried out. Press [↵] or [Rotary Encoder] to cancel the indication.

- 8** When “Finished” appears, press [Rotary encoder].

- This function is not available when Defeat is set to ON.
- Measurement of Auto TCR takes approximately 5 minutes.
- Auto TCR measurement result overwrites the manual TCR measurement result.
- Sound may arrive at the listening position at slightly different times, depending on the speaker and enclosure. To compensate for this, the distance can be adjusted to be larger than the actual distance.
- After the setting, it is recommended to store the setting contents on the unit. For details, refer to “Storing the Preset Values (Preset Store)” (page 36).

## Adjusting for Road Noise (RoadEQ)

RoadEQ (REAL-TIME OPTIMIZED ADAPTIVE DRIVING EQ) is a function to automatically adjust the EQ properties in accordance with the road noise while driving.

The Road Equalizer compensates for constantly changing noise, so always keep the microphones connected.

- 1** Preparing for measurement.

- Park the vehicle in a quiet location.
- Close doors, windows, sunroof, etc.
- Turn the air-conditioner and heater OFF.
- Turn off the engine of the vehicle.

- 2** Preparing the microphone.

Refer to the installation manual.

- 3** Turn the ignition switch of the vehicle to ACC (On).

- If an air-conditioner or heater is turned on, turn it off. Measurement should not be performed if air-conditioner or heater noise is present.

- 4** Press [FUNC.].

- 5** Rotate the [Rotary encoder] to select “RoadEQ,” and then press the [Rotary encoder].

- 6** Rotate the [Rotary encoder] to select “Calibration,” and then press the [Rotary encoder].



The CALIBRATION screen is displayed.

- 7** Press the [Rotary encoder].

Countdown will start.

During the 10 second countdown, go outside the vehicle and close the door.

A test signal will be output from the speakers to measure the acoustic characteristics of the cabin. Do not open any doors until the screen indicates “Finished.” If external noise interferes with the measurement, the “Calibration Error” message will appear on the screen. In this case, click [Rotary encoder] again to re-measure.

- If you want to stop measurement, press [↵].
- If the microphone is not connected, “No Mic” will be displayed and the measurement will not be carried out. Press [↵] or [Rotary Encoder] to cancel the indication.

- 8** When “Finished” appears, press [Rotary encoder].

- This function is not available when Defeat is set to ON.
- Measurement of RoadEQ takes approximately 7 minutes.
- When you select “Calibration” again, the previous setup data will be erased when count-down is started.
- Measurement values will not be lost in the event the system is reset or battery power is disconnected.

## Turning RoadEQ On/Off

When automatic measurement is completed, RoadEQ can be turned on or off and its level can be selected.

- 1** Press [FUNC.].

- 2** Rotate the [Rotary encoder] to select “Road EQ,” and then press the [Rotary encoder].

- 3** Rotate the [Rotary encoder] to select “Level Adjustment,” and then press the [Rotary encoder].



The LEVEL ADJUSTMENT screen is displayed.

- 4 Select one from “OFF” and “Level 1” through “Level 3” by rotating the [Rotary encoder], and press the [Rotary encoder].



Level 1: Low correction level. Suitable for quiet vehicles.  
 Level 2: Moderate correction level.  
 Level 3: High correction level. Suitable for high speed driving.

- If you do not use RoadEQ is not used, select “OFF”.

- 5 When the setting is complete, press and hold [↵] for at least 2 seconds.

- If [↵] is pressed during setting, the unit returns to the previous item.
- If measurement is not yet completed, or no microphone is connected, this setup is disabled.
- When you change the speaker setting of On/Off, RoadEQ automatically becomes off. When you have changed the speaker settings, start the measurement step over again.
- After the setting, it is recommended to store the setting contents on the unit. For details, refer to “Storing the Preset Values (Preset Store)” (page 36).

# Audio Setup/ Adjustment

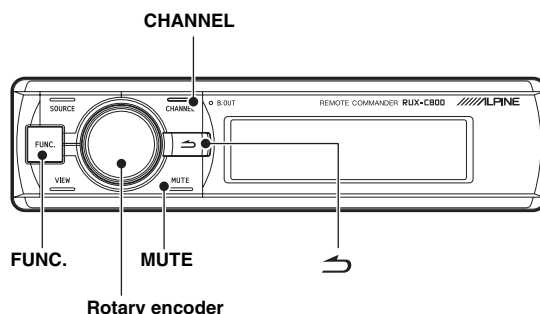

## Setting the MX Plus (Ai-NET Mode)

MX (Media Xpander) Plus enhances the vocal and instrumental sounds for music sources such as radio/CD/MP3, by generating harmonics lost during digital processing. This high frequency compensation adds clarity and detail normally lost to road noise.

This feature becomes enabled when an Ai-NET compatible head unit with MX Plus linking function is connected. If MX Plus mode is set for each source beforehand, it automatically switches according to the music source of the head unit.

- When a head unit with the MX Plus linking function, such as INA-W910, is connected, it should be set to Ai-NET mode. Other head units should be set in the Standalone mode.

- 1 Press [FUNC.].
- 2 Rotate the [Rotary encoder] to select “MX Plus,” and then press the [Rotary encoder].
- 3 Rotate the [Rotary encoder] to select “MX Plus Setup,” and then press the [Rotary encoder].



- 4 Rotate the [Rotary encoder] to select “ON,” and then press the [Rotary encoder].



- When you select [OFF], MX Plus for all music sources becomes disabled.
- 5 Rotate the [Rotary encoder] to select “Ai-NET,” and then press the [Rotary encoder].  
 MX Plus will become linked to the head unit.
- When a head unit without the MX Plus linking function is connected, this should be set as “Standalone,” even if it is an Ai-NET compatible head unit.

- 6 Press [↵] twice to go back to the screen for Step 3.
- 7 Rotate the [Rotary encoder] to select “Level Adjustment,” and then press the [Rotary encoder].
- 8 Select the source for the head unit by rotating the [Rotary encoder], and press the [Rotary encoder].



CD/Compressed Data/FM/Digital Radio/DVD/AUX/Others

- 9 Select the level you want by rotating the [Rotary encoder], and press the [Rotary encoder].  
MX Plus level increases in the following order: 1 → 2 → 3.

**FM (Level 1 to 3, OFF):**

The medium to high frequencies become clearer, and produces well balanced sound at all frequencies.

**CD (Level 1 to 3, OFF):**

CD mode processes a large amount of data during playback. MX takes advantage of this large data quantity to reproduce a more clear, clean output.

**Compressed Data/Digital Radio (Level 1 to 3, OFF):**

This corrects information that was lost at the time of compression. This reproduces a well-balanced sound close to the original.

**DVD (Cinema, Action, Music, OFF):**

**Cinema:**

Movie dialogue is clearly reproduced. Action movies are reproduced with more powerful sound.

**Action:**

Action movies are reproduced with more powerful sound.

**Music:**

Lower register sounds (drums, bass, etc.) and vocals are emphasized for clean and clear output.

**AUX / Others (Compressed, Music, DVD, OFF):**

MX mode suitable for the media (Compressed Data, Music, DVD) can be selected.

- 10 To adjust another source, press [↵] and repeat Steps 8 through 9.

- You can listen with Defeat OFF (adjusted setup values) or with Defeat ON (Initial value) to compare, by following the steps below.
  - 1 Press and hold the [Rotary Encoder] for 2 seconds or longer while in the adjustment mode.
  - 2 Rotate the [Rotary Encoder] to switch on/off Defeat, and listen to compare.
  - 3 To exit, select “OFF” and then press [↵].

- 11 When the setting is complete, press and hold [↵] for at least 2 seconds.

- If [↵] is pressed during setting, the unit returns to the previous item.
- To enable this function, Defeat should be set to ON.
- After the setting, it is recommended to store the setting contents on the unit. For details, refer to “Storing the Preset Values (Preset Store)” (page 36).

## Setting the MX Plus (Standalone Mode)

MX (Media Xpander) Plus enhances the vocal and instrumental sounds for music sources such as radio/CD/MP3, by generating harmonics lost during digital processing. This high frequency compensation adds clarity and detail normally lost to road noise.

In the Standalone mode, MX Plus does not become linked with the source of the head unit. MX Plus should be set for each external input. MX Plus mode will be switched, linked with the source switching of PXA-H800.

- 1 Press [FUNC.].
- 2 Rotate the [Rotary encoder] to select “MX Plus,” and then press the [Rotary encoder].
- 3 Rotate the [Rotary encoder] to select “MX Plus Setup,” and then press the [Rotary encoder].



- 4 Rotate the [Rotary encoder] to select “ON,” and then press the [Rotary encoder].

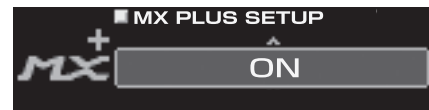

When you select [OFF], MX Plus for all music sources becomes disabled.

- If an Ai-NET compatible head unit is connected, go to Step 5.
- If an Ai-NET compatible head unit is not connected, go to Step 6.
- 5 Rotate the [Rotary encoder] to select “Standalone,” and then press the [Rotary encoder].

- When a head unit without the MX Plus linking function is connected, this should be set as “Standalone,” even if it is an Ai-NET compatible head unit.

- 6 Press [↵] once or twice to go back to the screen for Step 3.
- 7 Rotate the [Rotary encoder] to select “Level Adjustment,” and then press the [Rotary encoder].



- 8 Select the source for each external input by rotating the [Rotary encoder], and press the [Rotary encoder].



## 9 Select the level you want by rotating the [Rotary encoder], and press the [Rotary encoder].

### Compressed 1 to 3:

This corrects information lost in the compression process. This reproduces a well-balanced sound close to the original. By supplementing mid- to high- frequency sound data, the sound is reproduced with more brightness and ambience.

### Music 1 to 3:

Lower register sounds (drums, bass, etc.) and vocals are emphasized for clean and clear output.

### Cinema:

Video dialogue is reproduced more clearly. Action movies are reproduced with more powerful sound.

### Action:

Action movies are reproduced with more powerful sound.

### Drama/Talk:

The dialogue portion of a video is reproduced more clearly.

- When “Non Effect” is selected, MX Plus becomes disabled.
- Sources to be set vary depending on the system set in “Setting the AUX Input System (AUX Input Setup)” (page 39).

## 10 To adjust another source, press [↵] and repeat Steps 8 through 9.

- You can listen with Defeat OFF (adjusted setup values) or with Defeat ON (Initial value) to compare, by following the steps below.
  - 1 Press and hold the [Rotary Encoder] for 2 seconds or longer while in the adjustment mode.
  - 2 Rotate the [Rotary Encoder] to switch on/off Defeat, and listen to compare.
  - 3 To exit, select “OFF” and then press [↵].

## 11 When the setting is complete, press and hold [↵] for at least 2 seconds.

- If [↵] is pressed during setting, the unit returns to the previous item.
- This function is not available when Defeat is set to ON.
- After the setting, it is recommended to store the setting contents on the unit. For details, refer to “Storing the Preset Values (Preset Store)” (page 36).

## Setting the Equalizer Mode (EQ Mode)

You can choose either the Graphic EQ or the Parametric EQ for the equalizer mode. You can also turn it off. (Initial setting: “OFF”)

- 1 Press [FUNC.].
- 2 Rotate the [Rotary encoder] to select “Sound Field Adj.,” and then press the [Rotary encoder].
- 3 Rotate the [Rotary encoder] to select “Setup,” and then press the [Rotary encoder].
- 4 Rotate the [Rotary encoder] to select “EQ Mode,” and then press the [Rotary encoder].

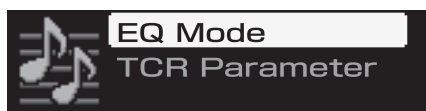

- 5 Select either “G.EQ,” “P.EQ,” or “OFF” by rotating the [Rotary encoder], and press the [Rotary encoder].



- G.EQ: Graphic EQ is used.
- P.EQ: Parametric EQ is used.
- OFF: EQ mode is disabled.

## 6 When the setting is complete, press and hold [↵] for at least 2 seconds.

- If [↵] is pressed during setting, the unit returns to the previous item.
- This function is not available when Defeat is set to ON.
- After the setting, it is recommended to store the setting contents on the unit. For details, refer to “Storing the Preset Values (Preset Store)” (page 36).

## Setting the Graphic EQ

The graphic equalizer allows you to modify the sound using 31 bands each for the front (left and right), rear (left and right) and center speakers. An additional 10 bands are available for the subwoofer. This allows you to customize the sound to suit your taste.

- Set “Setting the Equalizer Mode (EQ Mode)” on page 46 to “G.EQ.”

- 1 Press [FUNC.].
- 2 Rotate the [Rotary encoder] to select “Sound Field Adj.,” and then press the [Rotary encoder].
- 3 Rotate the [Rotary encoder] to select “EQ Adjustment,” and then press the [Rotary encoder].  
The G-EQ screen is displayed.



- 4 Press and hold [CHANNEL] for at least 2 seconds. Rotate the [Rotary encoder] to select either “L+R” or “L or R,” and press the [Rotary encoder].



- L→R: Channels Right and Left can be set independently.
- L+R: Both Right and Left channels are set at the same value (The initial setting).

- When you switch from “L or R” to “L+R,” choose which adjustment of the R and L channels to be applied.
  - 1 Select either “L→R” or “R→L” by rotating the [Rotary encoder], and press the [Rotary encoder].

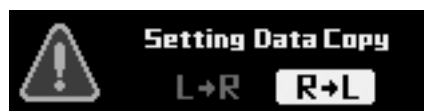

- L→R: The adjustment of the Left channel is to be applied to both Right and Left channels.
- R→L: The adjustment of the Right channel is to be applied to both Right and Left channels.

## 5 Select the channel you want to adjust by pressing [CHANNEL].

L+R selected: FRONT → REAR → CENTER →  
SUBWOOFER\*<sup>1</sup> → FRONT  
L or R selected: FRONT L → FRONT R → REAR L →  
REAR R → CENTER → SUBWOOFER\*<sup>2</sup>  
→ FRONT L

\*<sup>1</sup> If the Subwoofer output is set for Monaural, you can set both SUBWOOFER 1 and 2.

\*<sup>2</sup> If the Subwoofer output is set for Monaural, you can set SUBWOOFER 1 and 2. If the Subwoofer output is set for Stereo, you can set SUBWOOFER L and R.

• Channels to be set vary depending on the system set in "Setting the Speaker System (System Select)" (page 37).

## 6 Select the frequency by rotating the [Rotary encoder], and press the [Rotary encoder].

fc:  
FRONT/REAR/CENTER:  
20 Hz to 20kHz (in 1/3 octave steps) (1 to 31 Band)  
SUBWOOFER:  
20 Hz to 160 Hz (in 1/3 octave steps) (1 to 10 Band)

## 7 Adjust the level by rotating the [Rotary encoder], and press the [Rotary encoder].

Level: -12 to +12 dB (in 0.5 dB steps)\*<sup>3</sup>

\*<sup>3</sup> When ImprintEQ is enabled, 6 to +6 dB (in 0.5 dB steps)

## 8 To adjust another frequency, repeat Steps 6 and 7.

## 9 To adjust another channel, repeat Steps 5 through 8.

• You can listen with Defeat OFF (adjusted setup values) or with Defeat ON (Initial value) to compare, by following the steps below.

- 1 Press and hold the [Rotary Encoder] for at least 2 seconds while in the adjustment mode.
- 2 Rotate the [Rotary Encoder] to switch on/off Defeat, and listen to compare.
- 3 To exit, select "OFF" and then press [↵].

• You can mute the channel you are adjusting.

- 1 Press [MUTE] while in the adjustment mode to mute the channel.
- 2 To cancel muting, press [MUTE] again.

## 10 When the setting is complete, press and hold [↵] for at least 2 seconds.

- If [↵] is pressed during setting, the unit returns to the previous item.
- This function is not available when Defeat is set to ON.
- When the speaker is set to the "OFF" mode, the graphic equalizer for that speaker cannot be set. Refer to "Setting the Speaker System (System Select)" (page 37) / "Setting the Speakers (Speaker Setup)" (page 38).
- Check the playable frequency ranges of the connected speakers before making equalizer adjustments. If the speaker's playable frequency range is 55 Hz to 30 kHz, for example, adjusting the 40 Hz or 20 Hz band has no effect. Moreover, you may overload and damage the speakers.
- After the setting, it is recommended to store the setting contents on the unit. For details, refer to "Storing the Preset Values (Preset Store)" (page 36).

## Setting the Parametric EQ

The frequency bands of the graphic equalizer are fixed. This makes it difficult to correct for undesired peaks and dips at specific frequencies. The parametric equalizer's center frequency can be tuned to these specific frequencies. The bandwidth (Q) and level are then fine-tuned independently, to make the necessary corrections. The parametric equalizer function is an advanced tool for serious audiophiles.

- Set "Setting the Equalizer Mode (EQ Mode)" on page 46 to "P.EQ."

### 1 Press [FUNC.].

### 2 Rotate the [Rotary encoder] to select "Sound Field Adj.," and then press the [Rotary encoder].

### 3 Rotate the [Rotary encoder] to select "EQ Adjustment," and then press the [Rotary encoder].

The P-EQ screen is displayed.



### 4 Press and hold [CHANNEL] for at least 2 seconds. Rotate the [Rotary encoder] to select either "L+R" or "L or R," and press the [Rotary encoder].



L or R: Channels R and L can be set independently.

L+R: Both R and L channels are set at the same value (The initial setting).

- When you switch from "L or R" to "L+R," choose which adjustment of the R and L channels to be applied.

- 1 Select either "L→R" or "R→L" by rotating the [Rotary encoder], and press the [Rotary encoder].

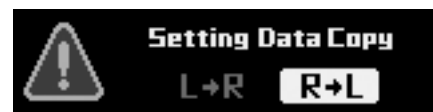

L→R: The adjustment of the L channel is to be applied to both R and L channels.

R→L: The adjustment of the R channel is to be applied to both R and L channels.

## 5 Select the channel you want to adjust by pressing [CHANNEL].

L+R selected: FRONT → REAR → CENTER →  
SUBWOOFER\*<sup>1</sup> → FRONT

L or R selected: FRONT L → FRONT R → REAR L →  
REAR R → CENTER → SUBWOOFER\*<sup>2</sup>  
→ FRONT L

\*<sup>1</sup> If the Subwoofer output is set for Monaural, you can set both SUBWOOFER 1 and 2.

\*<sup>2</sup> If the Subwoofer output is set for Monaural, you can set SUBWOOFER 1 and 2. If the Subwoofer output is set for Stereo, you can set SUBWOOFER L and R.

- Channels to be set vary depending on the system set in "Setting the Speaker System (System Select)" (page 37).

## 6 Select the band by rotating the [Rotary encoder], and press the [Rotary encoder].

Band:

FRONT/REAR/CENTER: 1 to 10

SUBWOOFER: 1 to 5

## 7 Adjust the frequency by rotating the [Rotary encoder], and press the [Rotary encoder].

fc:

FRONT/REAR/CENTER:

20 Hz to 20kHz (in 1/6 octave steps)

SUBWOOFER:

20 Hz to 200 Hz (in 1/6 octave steps)

## 8 Adjust the bandwidth (Q) by rotating the [Rotary encoder], and press the [Rotary encoder].

Q: 0.5/1.0/1.5/2.0/2.5/3.0/4.0/5.0 (8 steps)

## 9 Adjust the level by rotating the [Rotary encoder], and press the [Rotary encoder].

Level: -12 to +12 dB (in 0.5 dB steps)\*<sup>3</sup>

\*<sup>3</sup> When *ImprintEQ* is enabled, 6 to +6 dB (in 0.5 dB steps)

## 10 To adjust another band, repeat Steps 6 through 9.

## 11 To adjust another channel, repeat Steps 5 through 10.

• You can listen with Defeat OFF (adjusted setup values) or with Defeat ON (Initial value) to compare, by following the steps below.

- 1 Press and hold the [Rotary Encoder] for at least 2 seconds while in the adjustment mode.
- 2 Rotate the [Rotary Encoder] to switch on/off Defeat, and listen to compare.
- 3 To exit, select "OFF" and then press [↵].

• You can mute the channel you are adjusting.

- 1 Press [MUTE] while in the adjustment mode to mute the channel.
- 2 To cancel muting, press [MUTE] again.

## 12 When the setting is complete, press and hold [↵] for at least 2 seconds.

- If [↵] is pressed during setting, the unit returns to the previous item.
- This function is not available when Defeat is set to ON.
- When the speaker is set to the "OFF" mode, the parametric equalizer for that speaker cannot be set. Refer to "Setting the Speaker System (System Select)" (page 37)/"Setting the Speakers (Speaker Setup)" (page 38).
- Check the playable frequency ranges of the connected speakers before making equalizer adjustments. If the speaker's playable frequency range is 55 Hz to 30 kHz, for example, adjusting the 40 Hz or 20 Hz band has no effect. Moreover, you may overload and damage the speakers.
- After the setting, it is recommended to store the setting contents on the unit. For details, refer to "Storing the Preset Values (Preset Store)" (page 36).

## About the Crossover (X-Over)

### Crossover (X-Over):

This unit is equipped with an active crossover. The crossover limits the frequencies delivered to the outputs. Each channel is controlled independently. Thus, each speaker pair can be driven by the frequencies for which they have been optimally designed.

The crossover adjusts the HPF (high pass filter) or LPF (low pass filter) of each band, and also the slope (how fast the filter rolls off the highs or lows).

Adjustments should be made according to the reproduction characteristics of the speakers. Depending on the speakers, a passive network may not be necessary. If you are unsure about this point, please consult your authorized Alpine dealer.

	Cutoff frequency adjustment range (1/6 octave steps)	
	HPF	LPF
Front High	20Hz to 18kHz	22Hz to 20kHz
	1kHz to 18kHz (Tweeter only)	1.1kHz to 20kHz (Tweeter only)
Front Mid	20Hz to 18kHz	22Hz to 20kHz
Front Low	20Hz to 18kHz	22Hz to 20kHz
Rear	20Hz to 18kHz	22Hz to 20kHz
Center	20Hz to 18kHz	22Hz to 20kHz
Subwoofer	20Hz to 180Hz	22Hz to 200Hz

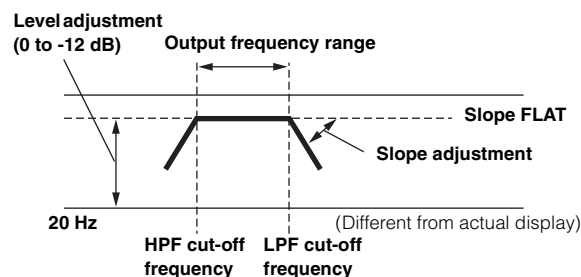

- **HPF (high pass filter):** Cuts the lower frequencies and allows higher frequencies to pass.
- **LPF (low pass filter):** Cuts the higher frequencies and allows lower frequencies to pass.
- **Slope:** The level change (in dB) for a frequency change of one octave.
- The higher the slope value, the steeper the slope becomes.
- Adjust the slope to FLAT (0 dB/oct) to bypass the HP or LP filters.
- Do not use a tweeter without the HPF on or set to a excessive low frequency, as it may cause damage to the speaker due to the low frequency content.
- You cannot adjust the crossover frequency higher than the HPF or lower than the LPF.
- Adjustment should be made according to the recommended crossover frequency of the connected speakers. Determine the recommended crossover frequency of the speakers. Adjusting to a frequency range outside that recommended may cause damage to the speakers. For the recommended crossover frequencies of Alpine speakers, refer to the respective Owner's Manual. We are not responsible for damage or malfunction of speakers caused by using the crossover outside the recommended values.



## Adjusting X-Over and Switching the Phases

This section describes how to adjust X-Over. Before working on this, refer to “About the Crossover (X-Over)” (page 48).

### Note on adjusting the subwoofer

If the subwoofer is installed on the rear deck, setting a gentle LPF slope (for example 6 dB/oct.) makes the sound localization more to the rear. This can also affect the acoustic localization of the front.

### Note on adjusting the high range

Depending on the speaker, inputting low frequency component signals (about 2 kHz or less) with the HPF adjustment could result in distortion. If distortion occurs, set a steep slope (for example 30 dB/oct.).

### Adjust so that the mid and high range sounds do not separate.

Normally use with the LPF turned off. If the high range is too strong, we recommend adjusting for a gentle slope.

### Note on adjusting the low range

When a subwoofer is connected and you are using a speaker with a low range of under 10 or 12 cm (3-15/16" or 4-3/4"), setting the low range HPF to “OFF” can result in distortion when low frequency components are input. If so, set the H.P.F. slope to a value suited for the speaker's frequency response.

- 1 Press [FUNC.].
- 2 Rotate the [Rotary encoder] to select “Sound Field Adj.,” and then press the [Rotary encoder].
- 3 Rotate the [Rotary encoder] to select “X-Over,” and then press the [Rotary encoder].  
The X-OVER screen is displayed.



- 4 Press and hold [CHANNEL] for at least 2 seconds. Rotate the [Rotary encoder] to select either “L+R” or “L or R,” and press the [Rotary encoder].



L or R: Channels R and L can be set independently.  
L+R: Both R and L channels are set at the same value (The initial setting).

- When you switch from “L or R” to “L+R,” choose which adjustment of the R and L channels to be applied.
  - 1 Select either “L→R” or “R→L” by rotating the [Rotary encoder], and press the [Rotary encoder].



L→R: The adjustment of the L channel is to be applied to both R and L channels.  
R→L: The adjustment of the R channel is to be applied to both R and L channels.

- 5 Select the channel you want to adjust by pressing [CHANNEL].

L+R selected: FRONT HIGH → FRONT MID → FRONT LOW → REAR → CENTER → SUBWOOFER\*1 → FRONT HIGH  
L or R selected: FRONT L HIGH → FRONT R HIGH → FRONT L MID → FRONT R MID → FRONT L LOW → FRONT R LOW → REAR L → REAR R → CENTER → SUBWOOFER\*2 → FRONT L HIGH

\*1 If the Subwoofer output is set for Monaural, you can set both SUBWOOFER 1 and 2.

\*2 If the Subwoofer output is set for Monaural, you can set SUBWOOFER 1 and 2. If the Subwoofer output is set for Stereo, you can set SUBWOOFER L and R.

- Channels to be set vary depending on the system set in “Setting the Speaker System (System Select)” (page 37).

- 6 Rotate the [Rotary encoder] to select “HPF,” and then press the [Rotary encoder].



- 7 Select the cut-off frequency (fc) by rotating the [Rotary encoder], and press the [Rotary encoder].

- The frequency that can be adjusted may vary depending on the channel (speaker). Refer to “About the Crossover (X-Over)” (page 48).

- 8 Adjust the slope by rotating the [Rotary encoder], and press the [Rotary encoder].



Slope: 0(OFF)/-6/-12/-18/-24/-30/-36 dB/oct\*3

- \*3 Neither LPF of Subwoofer nor HPF of Front High can be set at 0 (OFF).

- 9 Adjust the gain by rotating the [Rotary encoder], and press the [Rotary encoder].

Gain: -24 to 0 dB (in 0.5 dB steps)

- 10 Switch the phase by rotating the [Rotary encoder], and press the [Rotary encoder].



Phase: 0°/180°

This will take you back to the Step 6 screen.

- 11 Next, select “LPF” in Step 6, and repeat Steps 7 through 10 to adjust HPF.



## 12 To adjust another channel, repeat Steps 5 through 11.

- You can mute the channel you are adjusting.
  - Press [MUTE] while in the adjustment mode to mute the channel.
  - To cancel muting, press [MUTE] again.

## 13 When the setting is complete, press and hold [↵] for at least 2 seconds.

- If [↵] is pressed during setting, the unit returns to the previous item.
- When Tweeter is selected for FRONT HIGH to protect the speaker, there is no filter off (Slope OFF) setting for HPF. There is no filter off (Slope OFF) setting for Subwoofer LPF, either.
- When the speaker is in Off mode, X-Over does not affect the speaker. Refer to "Setting the Speaker System (System Select)" (page 37) / "Setting the Speakers (Speaker Setup)" (page 38).
- Check the playback frequencies of the connected speakers before adjusting.
- After the setting, it is recommended to store the setting contents on the unit. For details, refer to "Storing the Preset Values (Preset Store)" (page 36).

## Adjusting the Time Correction (TCR)

Because of the particular conditions inside the vehicle, there are major differences in the distances between the different speakers and the listening position. The proper time correction can be obtained using the automatic time correction function ("Auto TCR"), but it is also possible to calculate the optimum correction values and eliminate the time error at the listening position yourself using this function.

### ■ Calculation of time correction

**1 Sit in the listening position (the driver's seat, for example) and measure the distance (in meters) between your head and the various speakers.**

**2 Calculate the difference in distance between the farthest speaker and the other speakers.**

$$L = (\text{distance of farthest speaker}) - (\text{distance of other speakers})$$

**3 Divide the distances calculated for the different speakers by the speed of sound (343 m/s temperature 20°C).**

This value is the time correction value for the different speakers.

### Concrete examples

1 Calculating the time correction value for the front left speaker on the diagram below.

Conditions:

Distance between farthest speaker and listening position: 2.25 m (88-3/4")

Distance between front left speaker and listening position: 0.5 m (20")

Calculation:  $L = 2.25 \text{ m } (88\text{-}3/4\text{'}) - 0.5 \text{ m } (20\text{'}) = 1.75 \text{ m } (68\text{-}3/4\text{'})$   
 Compensation time =  $1.75 \div 343 \times 1000 = 5.1 \text{ (ms)}$

In other words, setting the time correction value for the front left speaker to 5.1 (ms) sets a virtual distance matching the distance to the farthest speaker.

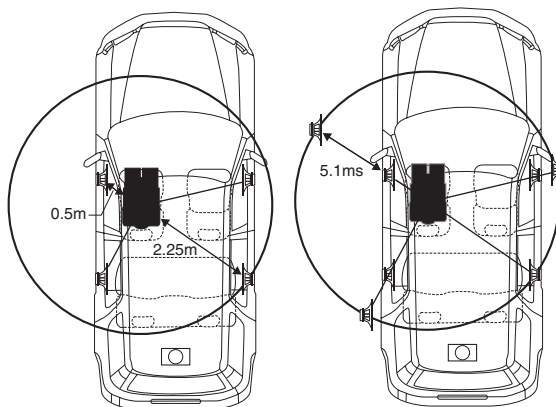

The sound is uneven because the distance between the listening position and the different speakers is different. The difference in the distance between the front left and rear right speakers is 1.75 meters (68-3/4").

Time correction eliminates the difference between the time required for the sound from the different speakers to reach the listening position. Setting the time correction of the front left speaker to 5.1 ms makes it possible to coordinate the distance from the listening position to the speaker.

### ■ Entering the time correction

- Press [FUNC.].
- Rotate the [Rotary encoder] to select "Sound Field Adj.," and then press the [Rotary encoder].
- Rotate the [Rotary encoder] to select "TCR", and then press the [Rotary encoder].  
The TCR screen is displayed.



- Select [ON] for "TCR" by rotating the [Rotary encoder], and press the [Rotary encoder].
  - When "OFF" is selected, the TCR function becomes disabled.
- Press and hold [CHANNEL] for at least 2 seconds. Rotate the [Rotary encoder] to select either "L+R" or "L or R," and press the [Rotary encoder].



L or R: Channels R and L can be set independently.  
 L+R: Both R and L channels are set at the same value (The initial setting).

- When you switch from "L or R" to "L+R," choose which adjustment of the R and L channels to be applied.
  - Select either "L→R" or "R→L" by rotating the [Rotary encoder], and press the [Rotary encoder].

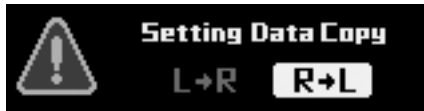

L→R: The adjustment of the L channel is to be applied to both R and L channels.

R→L: The adjustment of the R channel is to be applied to both R and L channels.

## 9 Select the channel you want to adjust by pressing [CHANNEL].

L+R selected: FRONT HIGH→FRONT MID→FRONT LOW→REAR→CENTER→SUBWOOFER\*<sup>1</sup>→FRONT HIGH

L or R selected: FRONT L HIGH→FRONT R HIGH→FRONT L MID→FRONT R MID→FRONT L LOW→FRONT R LOW→REAR L→REAR R→CENTER→SUBWOOFER\*<sup>2</sup>→FRONT L HIGH

\*<sup>1</sup> If the Subwoofer output is set for Monaural, you can set both SUBWOOFER 1 and 2.

\*<sup>2</sup> If the Subwoofer output is set for Monaural, you can set SUBWOOFER 1 and 2. If the Subwoofer output is set for Stereo, you can set SUBWOOFER L and R.

- Channels to be set vary depending on the system set in "Setting the Speaker System (System Select)" (page 37).

## 10 Adjust the calculated time correction value (0.00 to 20.00 ms) by rotating the [Rotary encoder].



Displaying the distances from the listening positions to the speakers

Setting contents: 0.00 to 20.00 ms (in 0.05 ms steps)

- The distances can be displayed in either "cm" or "inch" (see "Setting the Time Correction Adjustment Unit (TCR Parameter)" page 51).
- ## 11 To adjust another channel, repeat Steps 9 through 10.
- You can listen with Defeat OFF (adjusted setup values) or with Defeat ON (Initial value) to compare, by following the steps below.
    - Press and hold the [Rotary Encoder] for at least 2 seconds while in the adjustment mode.
    - Rotate the [Rotary Encoder] to switch on/off Defeat, and listen to compare.
    - To exit, select "OFF" and then press [↵].
  - You can mute the channel you are adjusting.
    - Press [MUTE] while in the adjustment mode to mute the channel.
    - To cancel muting, press [MUTE] again.

## 12 When the setting is complete, press and hold [↵] for at least 2 seconds.

- If [↵] is pressed during setting, the unit returns to the previous item.
- This function is not available when Defeat is set to ON.
- When the speaker is set to the "OFF" mode, the time correction for that speaker cannot be set. Refer to "Setting the Speaker System (System Select)" (page 37)/"Setting the Speakers (Speaker Setup)" (page 38).
- After the setting, it is recommended to store the setting contents on the unit. For details, refer to "Storing the Preset Values (Preset Store)" (page 36).

## Setting the Time Correction Adjustment Unit (TCR Parameter)

The unit of measurement for time correction can be set as either "cm" or "inch." (Initial setting: "cm")

- Press [FUNC.].
- Rotate the [Rotary encoder] to select "Sound Field Adj.," and then press the [Rotary encoder].
- Rotate the [Rotary encoder] to select "Setup," and then press the [Rotary encoder].
- Rotate the [Rotary encoder] to select "TCR Parameter," and then press the [Rotary encoder].



- Select either "cm" or "inch" by rotating the [Rotary encoder], and press the [Rotary encoder].



cm: The unit for the time correction becomes "cm."  
inch: The unit for the time correction becomes "inch."

- When the setting is complete, press and hold [↵] for at least 2 seconds.

- If [↵] is pressed during setting, the unit returns to the previous item.

# Use the Multi Channel Function

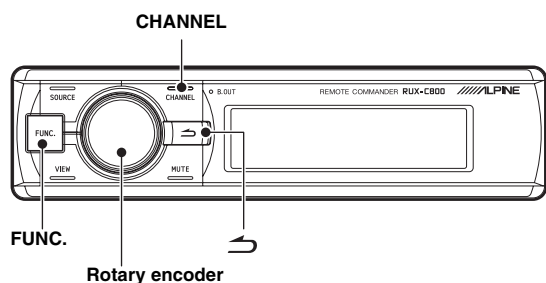

## Setting the 2-Channel Signal Playback Mode (Mode)

When playing back 2-Channel Stereo, select a playback mode best suited to the music. (Initial setting: "Stereo")

- 1 Press [FUNC.].
- 2 Rotate the [Rotary encoder] to select "Playback Mode," and then press the [Rotary encoder].
- 3 Rotate the [Rotary encoder] to select "Mode," and then press the [Rotary encoder].

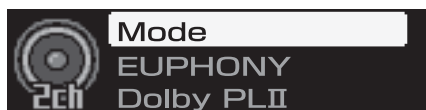

The Mode selection screen is displayed.

- 4 Select the playback mode you want by rotating the [Rotary encoder], and press the [Rotary encoder].



Setting contents: Stereo/Rear Fill/EUPHONY/Dolby PLII

- Stereo: Plays back in 2ch stereo.
- Rear Fill: Outputs the front signal from the rear.
- EUPHONY: Plays back in 5.1 channel surround (page 52).
- Dolby PLII: Plays back in Dolby Pro Logic II surround (page 53).

- 5 When the setting is complete, press and hold [↵] for at least 2 seconds.

- If [↵] is pressed during setting, the unit returns to the previous item.
- For linear PCM, the front signals are sent to the rear channel even if the system is set up for "Stereo."
- "Rear Fill" function  
Depending on the input signals, the sound may only be output from the front speakers. In this case, the "Rear Fill" function can be used to output signals from the rear speakers as well.

- If the setting of Rear Fill is made when Rear Mix is ON, sound is unchanged in the rear fill setting because Rear Mix is given priority during 2 channel decoder other than linear PCM.
- When both Rear and Center speakers are off in "Setting the Speaker System (System Select)" (page 37)/"Setting the Speakers (Speaker Setup)" (page 38), this item cannot be set.
- After the setting, it is recommended to store the setting contents on the unit. For details, refer to "Storing the Preset Values (Preset Store)" (page 36).

## Setting EUPHONY (EUPHONY)

EUPHONY creates 5.1 channel surround using Adaptive Surround technology based on a music signal recorded in 2-channel. When you set up EUPHONY and play back a CD or iPod stereo source, you can enjoy the realistic sensation of musicians playing around you. For DVD movie playback, you can enjoy the sense of localization of the dialogue and impressive three-dimensional sound effects. In this setting, EUPHONY Mode can be selected. (Initial setting: "ACOUSTIC")

- 1 Press [FUNC.].
- 2 Rotate the [Rotary encoder] to select "Playback Mode," and then press the [Rotary encoder].
- 3 Rotate the [Rotary encoder] to select "Mode," and then press the [Rotary encoder].  
The Mode selection screen is displayed.
- 4 Rotate the [Rotary encoder] to select "EUPHONY," and then press the [Rotary encoder].
- 5 Press [↵].  
This will take you back to the Step 3 screen.
- 6 Rotate the [Rotary encoder] to select "EUPHONY," and then press the [Rotary encoder].



- 7 Rotate the [Rotary encoder] to select the mode, and then press the [Rotary encoder].



Setting contents: ACOUSTIC/LIVE/CINEMA/TV SHOW/  
Custom 1/Custom 2/Custom 3

- ACOUSTIC: Localization is emphasized; the mode with regular sound field resonance.
- LIVE: Ambience is emphasized; the mode in which sound field resonance is more strongly felt.
- CINEMA: Sound suitable for movie audio. Dialogues are reproduced clearly and sound effect is crisp.
- TV SHOW: Sound suitable for broadcasting audio such as the digital broadcasting.
- Custom 1/Custom 2/Custom 3 can be selected only when the feature is set on a PC (see "Customizing EUPHONY" page 31).

## 8 When the setting is complete, press and hold [↵] for at least 2 seconds.

- If [↵] is pressed during setting, the unit returns to the previous item.
- When both Rear and Center speakers are off in “Setting the Speaker System (System Select)” (page 37)/“Setting the Speakers (Speaker Setup)” (page 38), this item cannot be set.
- This function only works with 2-channel signals.
- After the setting, it is recommended to store the setting contents on the unit. For details, refer to “Storing the Preset Values (Preset Store)” (page 36).

## Using Dolby Pro Logic II (Dolby PLII)

Pro Logic processing can be applied to the music signals recorded in 2-channel stereo. This gives normal 2-channel stereo a more live, concert hall effect. When you select “Music,” you can adjust the center width. This function provides the optimum vocal localization by adjusting the center channel localization in between the center speaker and the L/R speakers. (Initial setting: “Music”)

- 1 Press [FUNC.].
- 2 Rotate the [Rotary encoder] to select “Playback Mode,” and then press the [Rotary encoder].
- 3 Rotate the [Rotary encoder] to select “Mode,” and then press the [Rotary encoder].  
The Mode selection screen is displayed.
- 4 Rotate the [Rotary encoder] to select “Dolby PLII,” and then press the [Rotary encoder].
- 5 Press [↵].  
This will take you back to the Step 3 screen.
- 6 Rotate the [Rotary encoder] to select “Dolby PLII,” and then press the [Rotary encoder].



The DOLBY PLII screen is displayed.

- 7 Rotate the [Rotary encoder] to select “Music” or “Movie,” and then press the [Rotary encoder].

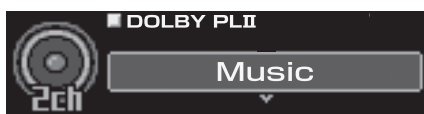

**Music:** Suits the stereo TV shows and all programs encoded in Dolby Surround. It improves the sound field directivity to near that of discrete 5.1-channel sound.

**Movie:** Can be used for all stereo music recordings, and provides a wide, deep sound field.

## 8 When the setting is complete, press and hold [↵] for at least 2 seconds.

- If [↵] is pressed during setting, the unit returns to the previous item.
- For the details of Dolby Pro Logic II, see page 61.
- When both Rear and Center speakers are off in “Setting the Speaker System (System Select)” (page 37)/“Setting the Speakers (Speaker Setup)” (page 38), this item cannot be set.
- This function only works with 2-channel signals.
- After the setting, it is recommended to store the setting contents on the unit. For details, refer to “Storing the Preset Values (Preset Store)” (page 36).

## Adjusting the Center Width (Center Width)

When you select “Music” for “Dolby Pro Logic II,” you can further adjust the center width in the following steps. This function offers the optimum vocal position by adjusting the center channel position between the center speaker and the L/R speaker. (The adjustments established in “Adjusting the Acoustic Image (BI-PHANTOM)” (page 55) are ineffective while this function is activated.) (Initial setting: “OFF”, “Level 0”)

- 1 Press [FUNC.].
- 2 Rotate the [Rotary encoder] to select “Playback Mode,” and then press the [Rotary encoder].
- 3 Rotate the [Rotary encoder] to select “Center Width,” and then press the [Rotary encoder].
- 4 Rotate the [Rotary encoder] to select “ON,” and then press the [Rotary encoder].



- 5 Adjust the level by rotating the [Rotary encoder].  
LEVEL: 0 to 7

When the level becomes higher, the center channel localization shifts from the center speaker toward both sides.

- 6 When the setting is complete, press and hold [↵] for at least 2 seconds.

- When the Center speaker is off in “Setting the Speaker System (System Select)” (page 37)/“Setting the Speakers (Speaker Setup)” (page 38), this item cannot be set.
- After the setting, it is recommended to store the setting contents on the unit. For details, refer to “Storing the Preset Values (Preset Store)” (page 36).

## Multi Channel Function Adjustment Procedure

Make the adjustments described below in order to reproduce Dolby Digital and DTS sound with greater accuracy.

**Setting the 2-Channel Signal Playback Mode (Mode) (page 52)**  
This sets the 2-channel signal playback mode.



**Adjusting the Acoustic Image (BI-PHANTOM) (page 55)**  
Adjusting the acoustic image to achieve a sound as if the center speaker were directly in front of the listener.



**Setting the Linear PCM (PCM Mode) (page 56)**  
You can choose either 2ch or 3ch for the playback output of a disc recorded on the linear PCM.



**Mixing the Low Range Audio of the Center with the Front L/R (Center Bass Split) (page 56)**  
Turning this feature on makes the audio signals emitted from the front L/R speakers mixed with the center audio signals (low range).



**Mixing the Low Range Audio for the Rear (Rear Mix) (page 55)**  
Achieving smooth sound in the rear seat by mixing the front audio signals with the rear speaker signals.



**Achieving Powerful High Volume Sound (Listening Mode) (page 56)**  
Achieving energetic sound with even greater power, like the sound in a movie theater.



**Adjusting the DVD Level (DVD Level) (page 57)**  
Adjust the volume signal level in each of the Dolby Digital, Dolby Pro Logic II, DTC and PCM modes.



**Adjusting the Speaker Volume Level (Output Level) (page 54)**  
Adjust each speaker's volume so they are the same level.



**Storing the Preset Values (Preset Store) (page 36)**  
Storing all the settings and adjustments made on the PXA-H800 (not only the above settings/adjusts) in the memory.

### In case of combining the Automatic adjustments, etc.

We recommend to make the Automatic adjustments before the Dolby Surround adjustments.

## Adjusting the Speaker Volume Level (Output Level)

The test tones help to make the volume adjustments of the different speakers. When levels are equal, a strong sense of presence can be heard from the different speakers at the listening position. (Initial setting: "±0dB")

- 1 Press [FUNC.].
- 2 Rotate the [Rotary encoder] to select "Multi Ch. Setup," and then press the [Rotary encoder].
- 3 Rotate the [Rotary encoder] to select "Output Level," and then press the [Rotary encoder].



OUTPUT LEVEL screen will be displayed and the test tone is produced from the left front speaker.

- 4 Select the channel by pressing [CHANNEL].  
Test tone is output from the selected channel.



ch.: Left/Center/Right/R-Surround/L-Surround

- Channels to be set vary depending on the system set in "Setting the Speaker System (System Select) (page 37)."

- 5 Adjust the speaker volumes for each channel to make them equal while the test tone is output from each channel. Adjust the level by rotating the [Rotary encoder].

LEVEL: -10 to +10 dB (in 1 dB steps)  
Adjust based on the front speakers.

- 6 To adjust another channel, repeat Steps 4 and 5.
- 7 When the setting is complete, press and hold [↵] for at least 2 seconds.

- If [↵] is pressed during setting, the unit returns to the previous item.
- Avoid stopping, pausing, switching the disc, cueing, fast-forwarding or switching the audio channel of this unit while making this adjustment. The setting is cancelled if the decode mode is switched.
- After the setting, it is recommended to store the setting contents on the unit. For details, refer to "Storing the Preset Values (Preset Store)" (page 36).

## Adjusting the Acoustic Image (BI-PHANTOM)

To install a center speaker, it must be located in the dash, an equal distance between the Left and Right speakers. In most cases, this is very difficult to achieve. Using BI-PHANTOM, a virtual center speaker is created by sending the center channel information to both the Left and Right speakers. Adjusting the center width in Dolby Pro Logic II "Music" (see "Using Dolby Pro Logic II (Dolby PLII)" on page 53), makes this function ineffective. This is used in a system where there is no sub-woofer and the rear speakers can produce lower frequency sounds than the front speakers. (Initial setting: "OFF", "±0 dB")

- 1 Press [FUNC.].
- 2 Rotate the [Rotary encoder] to select "Multi Ch. Setup," and then press the [Rotary encoder].
- 3 Rotate the [Rotary encoder] to select "BI-PHANTOM," and then press the [Rotary encoder].



- 4 Rotate the [Rotary encoder] to select "ON," and then press the [Rotary encoder].



Turning this feature on creates the acoustic image in which the center speaker is virtually located exactly in front of the listener by splitting the sound of the center speaker into both sides.

- 5 Adjust the level by rotating the [Rotary encoder].

LEVEL: -5 to +5 dB (in 1 dB steps)

The level can be adjusted between -5 and +5. When the level becomes greater, the acoustic image moves from the center speaker location toward both sides.

- 6 When the setting is complete, press and hold [↵] for at least 2 seconds.

- If [↵] is pressed during setting, the unit returns to the previous item.
- Do not perform operations such as Stop/Pause/Disc Exchange/Cue/Fast Forward/Audio Switching on the player during this setup adjustment. When the decode state switches, the settings will be cancelled.
- When the Center speaker is off in "Setting the Speaker System (System Select)" (page 37)/"Setting the Speakers (Speaker Setup)" (page 38), this item cannot be set.
- Effective only for Dolby Pro Logic II, EUPHONY and DTS (with Center signal).
- After the setting, it is recommended to store the setting contents on the unit. For details, refer to "Storing the Preset Values (Preset Store)" (page 36).

## Mixing the Low Range Audio for the Rear (Rear Mix)

This function mixes the front channel audio signals to the audio signals output from the rear speakers, improving the sound in the vehicle's rear seat. This is used in a system where there is no subwoofer and the rear speakers can produce lower frequency sounds than the front speakers. (Initial setting: "OFF", "±0 dB")

- 1 Press [FUNC.].
- 2 Rotate the [Rotary encoder] to select "Multi Ch. Setup," and then press the [Rotary encoder].
- 3 Rotate the [Rotary encoder] to select "Rear Mix," and then press the [Rotary encoder].



- 4 Rotate the [Rotary encoder] to select "ON," and then press the [Rotary encoder].



Turning this feature ON mixes the audio signals output from the rear speakers with the front audio signals.

- 5 Adjust the level by rotating the [Rotary encoder].

LEVEL: -6/-3/0/+3/+6 dB

The level can be adjusted in 5 steps. The higher the level, the more the low range audio is output from the rear speakers. (Depending on the software such as DVD, the effect may vary.)

- 6 When the setting is complete, press and hold [↵] for at least 2 seconds.

- If [↵] is pressed during setting, the unit returns to the previous item.
- Avoid stopping, pausing, switching the disc, cueing, fast-forwarding or switching the audio channel of this unit while making this adjustment. The setting is cancelled if the decode mode is switched.
- When the Rear speaker is off in "Setting the Speaker System (System Select)" (page 37)/"Setting the Speakers (Speaker Setup)" (page 38), this item cannot be set.
- Effective only for Dolby Pro Logic II, EUPHONY and DTS (with Rear signal).
- After the setting, it is recommended to store the setting contents on the unit. For details, refer to "Storing the Preset Values (Preset Store)" (page 36).



## Mixing the Low Range Audio of the Center with the Front L/R (Center Bass Split)

Turning on this function sends the Center channel low frequencies, equally to the front Left and Right speakers. This enhances the overall sound when using a small center speaker. This is used when the center speaker has a small diameter and cannot produce low frequency sounds. (Initial setting: "OFF", "315 Hz")

- 1 Press [FUNC.].
- 2 Rotate the [Rotary encoder] to select "Multi Ch. Setup," and then press the [Rotary encoder].
- 3 Rotate the [Rotary encoder] to select "Center Bass Split," and then press the [Rotary encoder].



- 4 Rotate the [Rotary encoder] to select "ON," and then press the [Rotary encoder].



Turning this feature ON mixes the audio signals output from the front L/R speakers with the center audio signals (low range).

- 5 Adjust the frequency by rotating the [Rotary encoder].

fc: 200 Hz/225 Hz/250 Hz/280 Hz/315 Hz/350 Hz/400 Hz/450 Hz/500 Hz

- 6 Press and hold [↵] for at least 2 seconds.

- If [↵] is pressed during setting, the unit returns to the previous item.
- Avoid stopping, pausing, switching the disc, cueing, fast-forwarding or switching the audio channel of this unit while making this adjustment. The effect may not be recognized easily depending on the decoding conditions.
- When the Center speaker is off in "Setting the Speaker System (System Select)" (page 37)/"Setting the Speakers (Speaker Setup)" (page 38), this item cannot be set.
- Effective only for Dolby Pro Logic II, EUPHONY and DTS (with Center signal).
- After the setting, it is recommended to store the setting contents on the unit. For details, refer to "Storing the Preset Values (Preset Store)" (page 36).

## Setting the Linear PCM (PCM Mode)

The output can be set to 2 or 3 channels when playing discs recorded in linear PCM. (Initial setting: "2ch")

- 1 Press [FUNC.].

- 2 Rotate the [Rotary encoder] to select "Multi Ch. Setup," and then press the [Rotary encoder].
- 3 Rotate the [Rotary encoder] to select "PCM Mode," and then press the [Rotary encoder].



- 4 Rotate the [Rotary encoder] to select "2ch" or "3ch," and then press the [Rotary encoder].



2ch: 2ch Output (L/R)  
3ch: 3ch Output (L/R/CENTER)

- 5 When the setting is complete, press and hold [↵] for at least 2 seconds.

- If [↵] is pressed during setting, the unit returns to the previous item.
- When the Center speaker is off in "Setting the Speaker System (System Select)" (page 37)/"Setting the Speakers (Speaker Setup)" (page 38), this item cannot be set.
- After the setting, it is recommended to store the setting contents on the unit. For details, refer to "Storing the Preset Values (Preset Store)" (page 36).

## Achieving Powerful High Volume Sound (Listening Mode)

With Dolby Digital, the dynamic range is compressed so that powerful sound can be achieved at regular volume levels. This compression can be cancelled to achieve an energetic sound with even greater power, like the sound in a movie theater. This function works only in the Dolby Digital mode. (Initial setting: "Standard")

- 1 Press [FUNC.].
- 2 Rotate the [Rotary encoder] to select "Multi Ch. Setup," and then press the [Rotary encoder].
- 3 Rotate the [Rotary encoder] to select "Listening Mode," and then press the [Rotary encoder].



- 4 Rotate the [Rotary encoder] to select "Standard" or "Maximum," and then press the [Rotary encoder].



Standard: To enjoy the dynamic sound at regular volume  
Maximum: To enjoy the dynamic sound at maximum volume



## 5 When the setting is complete, press and hold [↵] for at least 2 seconds.

- If [↵] is pressed during setting, the unit returns to the previous item.
- This feature is effective only for Dolby Digital.
- Use this feature at a volume level at which you can still hear sound outside of the cabin.
- Depending on the types of source, such as DVD software, this feature may be ineffective.
- After the setting, it is recommended to store the setting contents on the unit. For details, refer to "Storing the Preset Values (Preset Store)" (page 36).

## Adjusting the DVD Level (DVD Level)

The volume level for Dolby Digital, Dolby PLII, DTS, EUPHONY and PCM modes can be set. (Initial setting: "±0dB")

- 1 Press [FUNC.].
- 2 Rotate the [Rotary encoder] to select "Multi Ch. Setup," and then press the [Rotary encoder].
- 3 Rotate the [Rotary encoder] to select "DVD Level," and then press the [Rotary encoder].



- 4 Select the mode you want to adjust by rotating the [Rotary encoder], and press the [Rotary encoder].

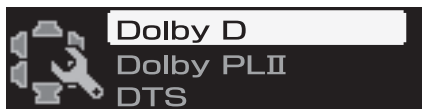

Adjustment modes: Dolby D/Dolby PLII/DTS/PCM/EUPHONY

- 5 Select the level by rotating the [Rotary encoder].

Adjustment level: -10 to +10 dB (in 1 dB steps)

- 6 Press [↵]. Repeat Steps 4 and 5 to set the levels for each mode.

- 7 When the setting is complete, press and hold [↵] for at least 2 seconds.

- If [↵] is pressed during setting, the unit returns to the previous item.
- Avoid stopping, pausing, switching the disc, cueing, fast-forwarding or switching the audio channel of this unit while making this adjustment. The effect may not be recognized easily depending on the decoding conditions.
- After the setting, it is recommended to store the setting contents on the unit. For details, refer to "Storing the Preset Values (Preset Store)" (page 36).

## Other Useful Features

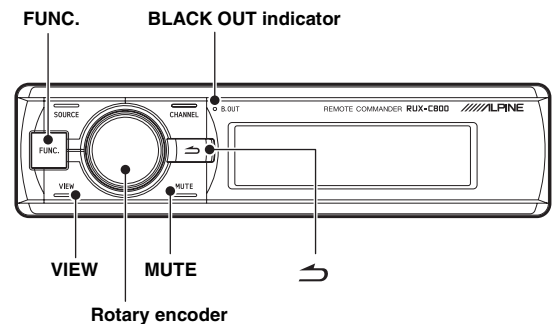

## Lowering Volume Quickly (Mute)

Activating this function will instantly lower the volume level by 20 dB.

- 1 Press [MUTE].  
The audio level decreases by about 20 dB. "-20 dB Mute" will be shown in the screen during muting.



- 2 To cancel muting, press [MUTE] again.

- Either switch will cancel muting.
- When an Ai-NET compatible head unit is connected, you cannot use this function.

## Turning the Back Light Off (BLACK OUT function)

When Blackout Mode is turned on, the backlight and illuminated buttons of the Commander display and the PXA-H800 indicators will be turned off to reduce power consumption. This additional power enhances the sound quality.

- 1 Press and hold the [Rotary encoder] for at least 2 seconds.  
The backlight is turned off. The BLACK OUT indicator will turn on.
- 2 To cancel this, press and hold the [Rotary encoder] again for at least 2 seconds.

- When another switch is operated while the backlight is off, the illumination backlight for the display is turned on for 5 seconds and then turned off again.

## Setting the Color for the Commander Illumination Button (ILLUMINATION)

You can change the lighting color of the buttons. (Initial setting: "BLUE")

- 1 Press [FUNC.].
- 2 Rotate the [Rotary encoder] to select "Display Setup," and then press the [Rotary encoder].
- 3 Rotate the [Rotary encoder] to select "ILLUMINATION," and then press the [Rotary encoder].



- 4 Rotate the [Rotary encoder] to select "BLUE" or "RED."



- 5 When the setting is complete, press and hold [↵] for at least 2 seconds.

- If [↵] is pressed during setting, the unit returns to the previous item.

## Adjusting the Brightness of the Display (Dimmer)

Set the Dimmer control to "Auto" to decrease the illumination brightness of the unit with the head lights of the vehicle ON. This mode is useful if you feel the unit's backlighting is too bright at night. (Initial setting: "Auto")

- 1 Press [FUNC.].
- 2 Rotate the [Rotary encoder] to select "Display Setup," and then press the [Rotary encoder].
- 3 Rotate the [Rotary encoder] to select "Dimmer," and then press the [Rotary encoder].



- 4 Rotate the [Rotary encoder] to select "Auto" or "Manual."



- 5 When the setting is complete, press and hold [↵] for at least 2 seconds.

- If [↵] is pressed during setting, the unit returns to the previous item.
- When "Manual" is selected, the brightness of the display does not change if you turn on the headlamps. This always sets the brightness at the level specified in "Adjusting the Brightness Level of the Display (Dimmer Level)" (page 58).

## Adjusting the Brightness Level of the Display (Dimmer Level)

With the Dimmer control ON, three Dimmer levels are available. The highest, Level 3, being the most dim with the vehicle's headlights ON. (Initial setting: "Level 1")

- 1 Press [FUNC.].
- 2 Rotate the [Rotary encoder] to select "Display Setup," and then press the [Rotary encoder].
- 3 Rotate the [Rotary encoder] to select "Dimmer Level," and then press the [Rotary encoder].



- 4 Select one from "Level 1" through "Level 3" by rotating the [Rotary encoder].



- 5 When the setting is complete, press and hold [↵] for at least 2 seconds.

- If [↵] is pressed during setting, the unit returns to the previous item.

## Switching the Display

You can select the display mode you want.

### 1 Press [VIEW].

The display mode switches for every push.

#### ALPINE LOGO



#### Source display\*



#### Voltage/Temperature display



Power voltage

Temperature inside the unit



#### Currently playing input audio stream channel information display



#### Effective status of each function and playing stream format information display



#### ALPINE LOGO



\* When an Ai-NET compatible head unit is connected, the source screen will not be displayed.

# Information

## System Configuration

**Table 1 (Output System)**

Speaker System	CH-1(L)	CH-2(R)	CH-3(L)	CH-4(R)	CH-5(L)	CH-6(R)	CH-7(L)	CH-8(R)
<b>F-2way+R+SW (4.2ch system)</b>	Front2Way				Rear		Subwoofer	
	Front High(L)	Front High(R)	Front Low(L)*	Front Low(R)*	Rear(L)	Rear(R)	Subwoofer(L)	Subwoofer(R)
<b>F-3way+SW (2.2ch system)</b>	Front3Way						Subwoofer	
	Front High(L)	Front High(R)	Front Mid(L)*	Front Mid(R)*	Front Low(L)	Front Low(R)	Subwoofer(L)	Subwoofer(R)
<b>F-3way+R (4.0ch system)</b>	Front3Way						Rear	
	Front High(L)	Front High(R)	Front Mid(L)*	Front Mid(R)*	Front Low(L)	Front Low(R)	Rear(L)	Rear(R)
<b>F-2way+R+C+SW (5.1ch system)</b>	Front2Way				Rear		Center	Subwoofer
	Front High(L)	Front High(R)	Front Low(L)*	Front Low(R)*	Rear(L)	Rear(R)	Center	Subwoofer

\* Cannot be set to OFF.

**Table 2 (Input System)**

RCA Input Pattern	AUX INPUT					
	CH-1 (L)	CH-2 (R)	CH-3 (L)	CH-4 (R)	CH-5 (L)	CH-6 (R)
<b>5.1ch Input</b>	AUX1					
	FL (Front Left)	FR (Front Right)	RL (Rear Left)	RR (Rear Right)	C (Center)	SubW (Subwoofer)
<b>4ch&amp;2ch Input</b>	AUX1				AUX2	
	FL (Front Left)	FR (Front Right)	RL (Rear Left)	RR (Rear Right)	L (Left)	R (Right)
<b>2chx3 Input</b>	AUX1		AUX2		AUX3	
	L (Left)	R (Right)	L (Left)	R (Right)	L (Left)	R (Right)

---

## Terminology

---

### Dolby Digital

Dolby Digital is a digital audio compression technology developed by Dolby Laboratories that allows large quantities of audio data to be efficiently recorded on discs. It is compatible with audio signals from mono (1 channel) all the way up to 5.1-channel surround sound. The signals for the different channels are completely independent, and since the sound is high quality digital there is no loss of sound quality.

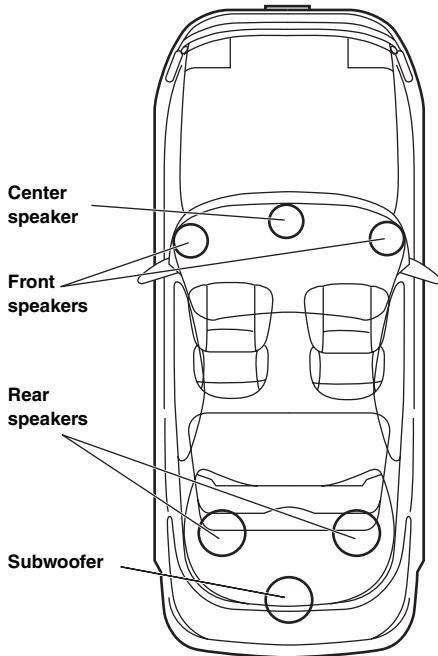

**Speaker layout for enjoying  
Dolby Digital sound/DTS sound**

### DTS

This is a home-use digital sound format of the DTS Sound System. This is a high quality sound system, developed by Digital Theater Systems Corp for use in movie theaters. DTS has six independent sound tracks. The theater presentation is fully realized in the home and other settings. DTS is the abbreviation for Digital Theater Systems

### Dolby Pro Logic II

Dolby Pro Logic II provides multichannel surround sound from any 2 channel source. It reproduces extended bandwidth playback with 5.1 channels. This is made possible by an advanced matrix surround decoder. This new decoder is able to draw out spatial characteristics of the recording without adding tonal coloration or artificial delays that did not exist in the original.

### Linear PCM audio

LPCM is a signal recording format used for music CDs. Whereas music CDs are recorded at 44.1 kHz/ 16 bits, DVDs are recorded at 48 kHz/16 bits to 96 kHz/24 bits, thereby achieving higher sound quality than music CDs.

---

## In Case of Difficulty

---

If you encounter a problem, please turn the power off, then on again. If the unit is still not functioning normally, please review the items in the following checklist. This guide will help you isolate the problem if the unit is at fault. Otherwise, make sure the rest of your system is properly connected or consult your authorized Alpine dealer.

### No function or display.

- Vehicle's ignition is off.
  - Turn the ignition key on. If connected as per the instructions, the unit will not operate with the vehicle's ignition off.
- Unit's power is not on.
  - Turn the ignition key on. Press one of the switches on the Commander to turn power on. If an Ai-NET compatible head unit is connected, turn on the power by the head unit.
- Power cord connection is faulty.
  - Connect the power cord correctly.
- Display does not show anything (BLACK OUT function).
  - Cancel BLACK OUT function (see page 57).
- Blown fuse.
  - Check the fuse of the unit; replace with the proper value if necessary.
- Internal micro-computer malfunctioned due to interference noise etc.
  - Press the RESET switch with a ball-point pen or other pointed article.

### Power is on but no sound is coming out.

- Volume level is at Minimum.
  - Raise the volume level (see pages 12, 36).
- External input system does not match the setup.
  - Set the system so that it matches the connected input (see pages 14, 39).

### The sound is not output from the speakers.

- Cord connection is faulty.
  - Connect the cord correctly.
- Speaker is in "OFF mode."
  - Put the speakers in "ON mode" (see pages 14, 38).
- Subwoofers are "OFF."
  - Turn the subwoofers "ON" (see pages 14, 38).

### Sound adjustment disabled.

- Defeat is "ON."
  - Turn Defeat Off (see pages 12, 36).

### DVD volume low.

- Volume levels can be different between CD and DVD.
  - Adjust the DVD Level (see pages 34, 57).

### Sources cannot be selected.

- Ai-NET device is connected.
  - When an Ai-NET compatible head unit is connected, the source should be switched at the head unit.

### Dolby Pro Logic II volume level low.

- Dolby Pro Logic II volume level is generally lower.
  - Raise the volume level (see pages 12, 36).

### Dolby D/Dolby PLII/DTS indicators flash at 1 second intervals simultaneously.

- Software upgrade to a newer version failed.
  - Consult your Alpine dealer.

### POWER indicator flashes at 1 second intervals.

- A failure has occurred.
  - Following the instruction on the screen, conduct the corrective measures. Or, consult your Alpine dealer.

### RoadEQ does not work.

- Microphone not connected.
  - Check to see that the microphone is correctly connected. Also, make sure that the cord is not extremely bent.
- RoadEQ setup not completed.
  - Check to see that RoadEQ is correctly completed.

### An error during Automatic ImprintEQ adjustment has occurred.

- External noise is interfering with measurement.
  - Conduct the measurement in a quiet location.
- The speaker bandwidth may be too narrow.
  - Check the X-Over setting of each speaker.
- Gain setting of the amplifier may be too low.
  - Check the Gain setting.

### Software upgrade to a newer version failed.

- During software upgrade, the USB cable was unplugged, the ignition key is turned to OFF position, the unit was affected by another program, etc.
  - Stop all active programs, and then upgrade the software again (see page 11).
  - If you still have trouble, stop use of the unit and consult your Alpine dealer.

---

## Indication (Commander RUX-C800)

### Calibration Error

- Automatic measurement failed for whatever reason.
  - Press "Rotary Encoder" to go back to the previous screen and perform the measurement again.

---

### No Mic

- Microphone not connected.
  - Check to see that the microphone is correctly connected. Also, make sure that the cord is not extremely bent.

---

### No Mic/RoadEQ Off

- Even when RoadEQ is turned on, if no microphone is connected, RoadEQ is turned off.
  - Check to see that the microphone is correctly connected. Also, make sure that the cord is not extremely bent.

---

### No Data

- Settings are called but there is no preset data stored in the system.
  - Store the preset values.

---

### System Mismatch

- The called preset values do not match the current speaker system.
    - Store the preset values again, using the current speaker system.
-

## HI-TEMP (Over 85°C)

- Cabin temperature is too high (temperature inside the unit 85°C or higher).
  - Lower the cabin temperature to normal.

## Audio Supply Voltage Low

- Unit internal voltage is abnormal.
  - Turn off the system immediately and contact an Alpine dealer.

## Remote Out Voltage Low

- Connected device voltage is abnormal.
  - Check for any abnormal connection with the externally connected devices including amplifiers.

## Battery Voltage High

- Vehicle battery voltage is high.
  - Check the battery voltage.

## Battery Voltage Low

- Vehicle battery voltage is low.
  - Check the battery voltage.



- Analog input audio signal level too high causing clipping.
  - Lower the Analog input audio signal level.



- The level was raised too much with EQ settings and DSP output was clipped.
  - Lower the adjusted level of EQ, etc.
  - Lower the volume.



- Cabin temperature is too high. (Internal temperature warning)
  - Lower the cabin temperature to normal.

## Specifications

Graphic EQ number of bands	
Front (left and right)	31 bands
Rear (left and right)	31 bands
Center	31 bands
Subwoofer	10 bands
Graphic EQ boost cut range	±12 dB (in 0.5 dB steps)
Parametric EQ number of bands	
Front/Rear/Center	10 bands
Subwoofer	5 bands
Parametric EQ frequency	
Front/Rear/Center	20/22/25/28/31.5/36/40/45/50/ 56/63/71/80/90/100/110/125/ 140/160/180/200/220/250/280/ 315/360/400/450/500/560/630/ 710/800/900/1k/1.1k/1.2k/1.4k/ 1.6k/1.8k/2k/2.2k/2.5k/2.8k/3.2k/ 3.6k/4k/4.5k/5k/5.6k/6.3k/7.1k/ 8k/9k/10k/11k/12.5k/14k/16k/ 18k/20k(Hz)
Initial setting:	
Band 1	31.5 Hz
Band 2	63 Hz
Band 3	125 Hz
Band 4	250 Hz
Band 5	500 Hz
Band 6	1 kHz
Band 7	2 kHz
Band 8	4 kHz
Band 9	8 kHz
Band 10	16 kHz
Subwoofer	20/22/25/28/31.5/36/40/45/50/ 56/63/71/80/90/100/110/125/ 140/160/180/200(Hz)
Initial setting:	
Band 1	25 Hz
Band 2	40 Hz
Band 3	63 Hz
Band 4	100 Hz
Band 5	160 Hz
Parametric EQ boost cut range	±12 dB (in 0.5 dB steps)
Time correction control range	0 to 20 ms (0.05 ms steps)
Frequency response	20 Hz to 20 kHz
S/N ratio	>103 dB (IHF-A) (RCA INPUT) >110 dB (IHF-A) (DIGITAL INPUT)
Channel separation	90 dB
Input sensitivity	2 V (Analog) (RCA AUX INPUT) 7 V (Analog) (SP AUX INPUT)
Subwoofer crossover	20 to 200 Hz (1/6 oct. steps)
Rated output	4V (with 10 k ohms load)
Distortion factor	0.01%
Input impedance	10 k ohms or higher
Output impedance	1 k ohm or less
Weight	
PXA-H800	1.35 kg
RUX-C800	0.11 kg



## Dimensions

### PXA-H800

Width	169 mm (6-3/4")
Height	50.8 mm (2")
Depth	215 mm (8-1/2")

### RUX-C800

Width	161 mm (6-3/8")
Height	40 mm (1-5/8")
Depth	28 mm (1-1/8")

## <Components>

Parts name	Quantity
Parts for mounting .....	1set
Manual .....	1set
Microphone .....	1set
CD-ROM .....	2pieces

Due to continuous product improvement, specifications and design are subject to change without notice.

The illustrations included in these instructions may appear different from the actual product due to printing conditions.

- Manufactured under license from Dolby Laboratories. Dolby, Pro Logic, and the double-D symbol are trademarks of Dolby Laboratories.
- Manufactured under license under U.S. Patent #'s: 5,451,942; 5,956,674; 5,974,380; 5,978,762; 6,487,535 & other U.S. and worldwide patents issued & pending. DTS and the Symbol are registered trademarks & DTS Digital Surround and the DTS logos are trademarks of DTS, Inc. Product includes software. © DTS, Inc. All Rights Reserved.
- EUPHONY and EUPHONY AUTOMOBILE are trademarks of DiMAGIC Co., Ltd.